

# Regulisani elektromotorni pogoni sa asinhronim mašinama – **Direktna kontrola momenta**

Istorijski pregled

Opis metode

Način realizacije

Podešavanje parametara regulatora brine

Pregled karakteristika

Prevazilaženje nedostataka

# Direktna kontrola momenta DTC (Direct Torque Control)

- Jedna metoda upravljanja trenutnim vrednostima momenta i fluksa.
- Pruža određene prednosti u odnosu na vektorsko upravljanje.
- Metoda je bazirana na topologiji naponskog invertora.
- Može se prilagoditi i pogonima sa strujnim invertorima.

# A New Quick-Response and High-Efficiency Control Strategy of an Induction Motor

ISAO TAKAHASHI, MEMBER, IEEE, AND TOSHIHIKO NOGUCHI

**Abstract**—New quick-response and high-efficiency control of an induction motor, which is quite different from that of the field-oriented control is proposed. The most obvious differences between the two are as follows. 1) The proposed scheme is based on limit cycle control of both flux and torque using optimum PWM output voltage; a switching table is employed for selecting the optimum inverter output voltage vectors so as to attain as fast a torque response, as low an inverter switching frequency, and as low harmonic losses as possible. 2) The efficiency optimization in the steady-state operation is also considered; it can be achieved by controlling the amplitude of the flux in accordance with the torque command. To verify the feasibility of this scheme, experimentation, simulation, and comparison with field-oriented control are carried out. The results prove the excellent characteristics for torque response and efficiency, which confirm the validity of this control scheme.

## I. INTRODUCTION

ACCORDING to the advance of factory automation, servo systems became indispensable to applications such as industrial robots and numerically controlled machinery. Especially the progress of an ac-servo system is remarkable, owing to the fact that it is maintenance-free. In recent years, field-oriented control has been employed that enables an induction motor to attain as quick torque response as a dc motor. The principle of its torque generation is based on the interaction between the flux and current, like a dc motor [1]. Fig. 1(a) is a system configuration of a typical field-orientation drive. In this system the flux current component  $I_d^*$  and the torque current component  $I_q^*$  are estimated from both flux command  $\psi_f^*$  and torque command  $T^*$  by using a calculator possessing motor parameters. The system usually employs a position sensor for coordinate transformation of the current components and a current-controlled inverter. Therefore, if the values used in the calculator deviate from the correct ones, both steady-state and transient response would be degraded. A number of papers have reported the problem and have explored the means of compensation [2]–[4]. There also remain some problems concerning instantaneous current control. Since the current-controlled inverter contains three independent hysteresis comparators, it is difficult to avoid increase of the inverter switching frequency, torque ripple, and harmonic losses of the machine in the steady-state

Paper IPCSD 86-4, approved by the Industrial Drives Committee of the IEEE Industry Applications Society for presentation at the 1985 Industry Applications Society Annual Meeting, Toronto, ON, Canada, October 6–11. This work supported by the Heavy Apparatus Standard Products Department of the Toshiba Corporation. Manuscript released for publication February 5, 1986.

The authors are with the Technological University of Nagaoka, 1603-1 Kamiotomioka, Nagaoka, Japan 949-54.  
IEEE Log Number 8609012.

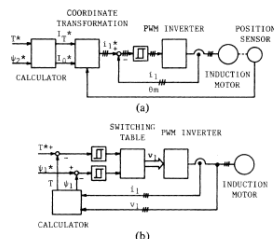

Fig. 1. Comparison of two schemes. (a) Field-oriented control. (b) New proposed scheme.

operation. Moreover, when the PWM inverter saturates, sufficient torque response would not be expected.

This paper describes a novel control scheme of an induction motor [5]. The principle of it is based on limit cycle control, and it makes possible both quick torque response and high-efficiency operation at the same time. Fig. 1(b) shows a system configuration of the proposed scheme. In this system, the instantaneous values of the flux and torque are calculated from only the primary variables. They can be controlled directly and independently by selecting optimum inverter switching modes. The selection is made so as to restrict the errors of the flux and torque within the hysteresis bands and to obtain the fastest torque response and highest efficiency at every instant. It enables both quick torque response in the transient operation and reduction of the harmonic losses and acoustic noise. Moreover, the implementation of an efficiency controller for the improvement of efficiency in the steady-state operation is also considered.

## II. DYNAMIC BEHAVIOR OF AN INDUCTION MOTOR

By using instantaneous vectors, the behavior of a machine can be conveniently expressed not only in the steady state but also in the transient state. In this section, to examine the transient torque response of an induction motor, an application of the vectors to the characteristic equations is described.

The primary voltage vector  $v_1$  is defined by the following expression [6]:

$$v_1 = \sqrt{2/3} [v_{1a} + v_{1b} \exp(j2\pi/3) + v_{1c} \exp(j4\pi/3)] \quad (1)$$

0093-9994/86/0900-0820\$01.00 © 1986 IEEE

# Istorijski pregled

Kompanija ABB je 1995. ponudila na tržište prvi industrijski pretvarač sa direktnom kontrolom momenta – ACS 600.

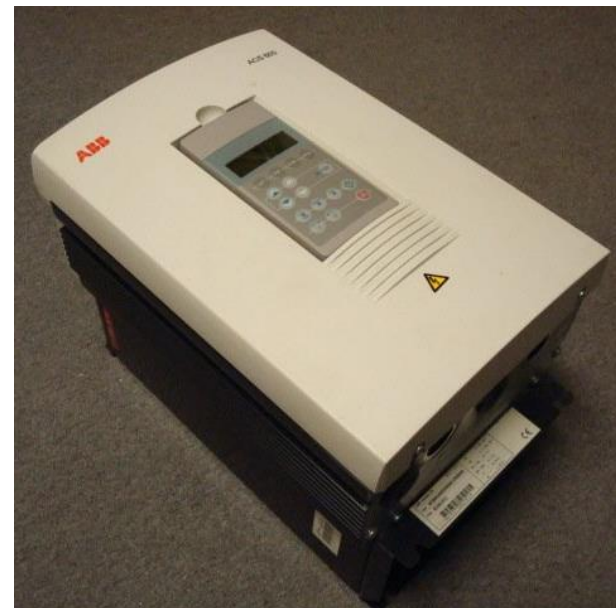

IEEE TRANSACTIONS ON INDUSTRY APPLICATIONS,  
VOL. IA-22, NO. 5, SEPTEMBER/OCTOBER 1986

A New Quick-Response and High-Efficiency  
Control Strategy of an Induction Motor  
ISAO TAKAHASHI, MEMBER, IEEE, AND TOSHIHIKO NOGUCHI

# Šta je cilj?

## Struktura regulisanog pogona koju želimo da ostvarimo:

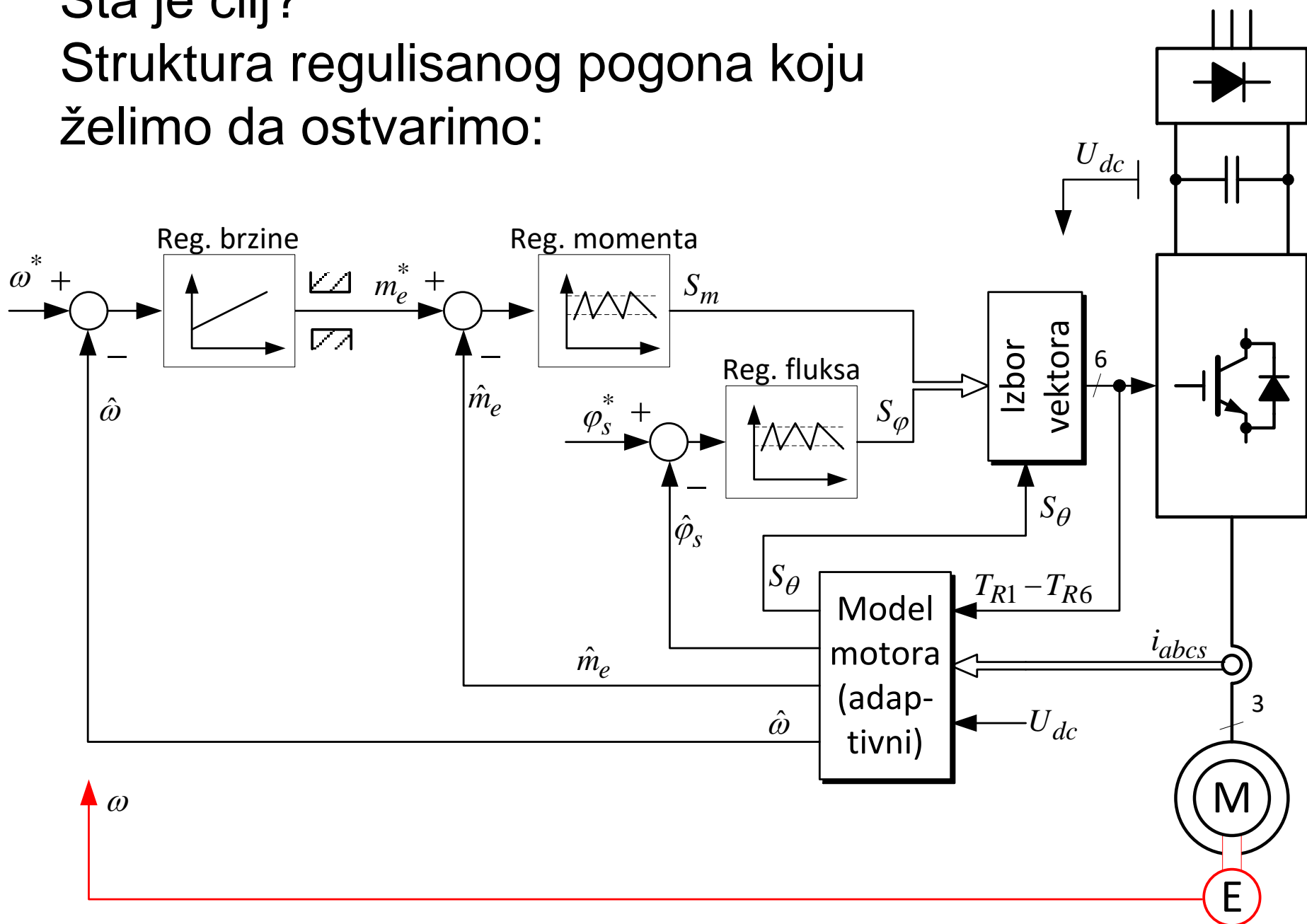

# Stacionarni referentni sistem

$$\omega_{rs} = 0$$

Statorske jednačine

$$u_{qs} = R_s \cdot i_{qs} + \frac{d}{dt} \varphi_{qs} \quad (1) \quad \varphi_{qs} = L_s \cdot i_{qs} + M \cdot i'_{qr} \quad (5)$$

$$u_{ds} = R_s \cdot i_{ds} + p \frac{d}{dt} \varphi_{ds} \quad (2) \quad \varphi_{ds} = L_s \cdot i_{ds} + M \cdot i'_{dr} \quad (6)$$

Rotorske jednačine

$$0 = R'_r \cdot i'_{qr} + \frac{d}{dt} \varphi'_{qr} - \omega \cdot \varphi'_{dr} \quad (3) \quad \varphi'_{qr} = L'_r \cdot i'_{qr} + M \cdot i_{qs} \quad (7)$$

$$0 = R'_r \cdot i'_{dr} + \frac{d}{dt} \varphi'_{dr} + \omega \cdot \varphi'_{qr} \quad (4) \quad \varphi'_{dr} = L'_r \cdot i'_{dr} + M \cdot i_{ds} \quad (8)$$

Jednačina momenta

$$m_e = \frac{3}{2} P \cdot (i_{qs} \cdot \varphi_{ds} - i_{ds} \cdot \varphi_{qs}) \quad (9)$$

# Jednačina momenta u vektorskoj formi

$$\vec{m}_e = \frac{3}{2} P \cdot \vec{i}_s \times \vec{\varphi}_s = \frac{3}{2} P \cdot |\vec{i}_s| \cdot |\vec{\varphi}_s| \cdot \sin \gamma$$

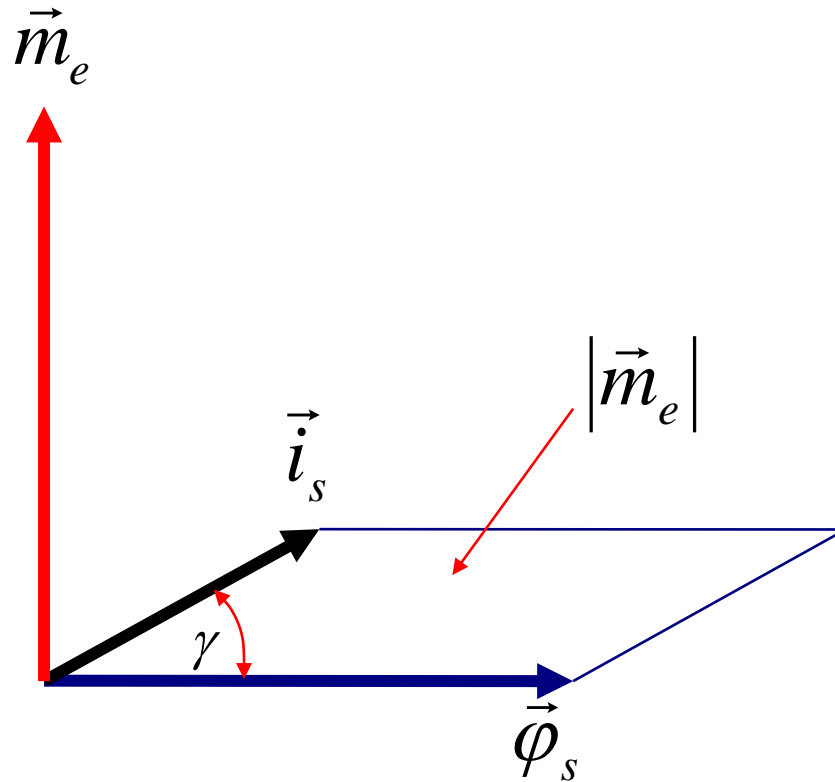

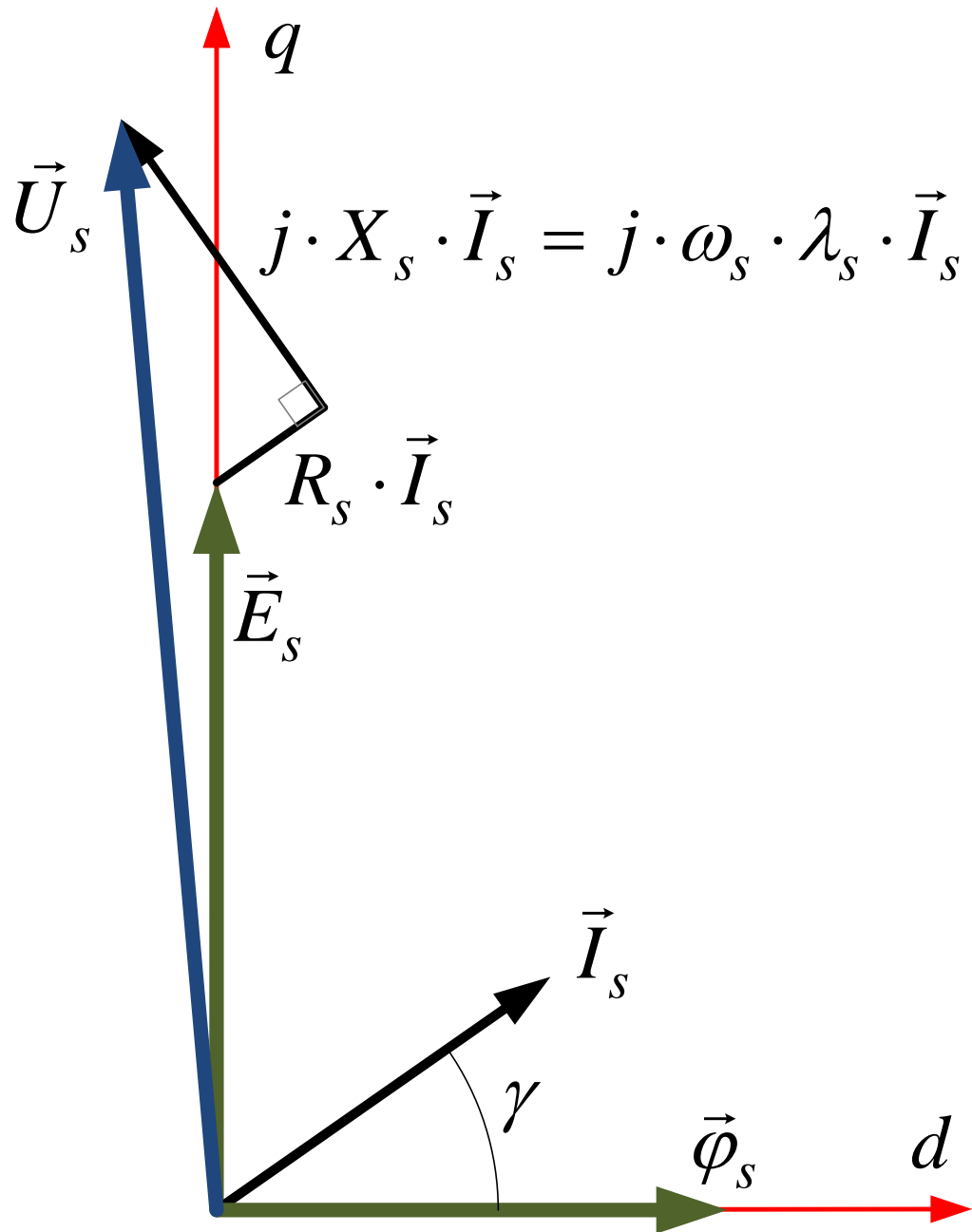

# Fazorski dijagram statorskih veličina

Uvek nam je potreban stalan fluks.

Struja, odnosno moment motora se može podešavati podešavanjem trenutne vrednosti vektora napona.

# Transformacije statorskih veličina

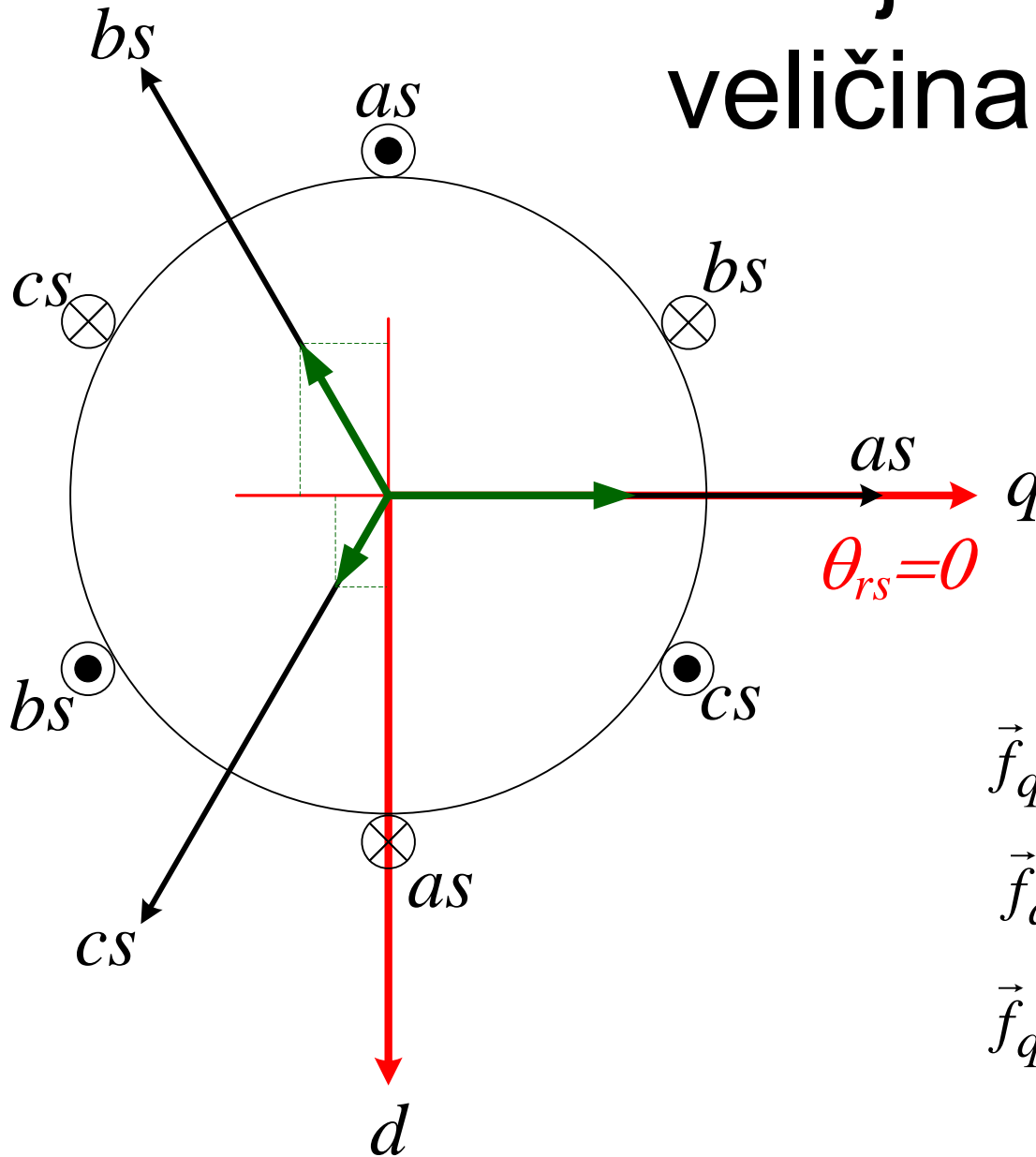

$$\omega_{rs} = 0, \theta_{rs}(0) = 0$$

$$\vec{f}_{qd0s} = \mathbf{K}_s \cdot \vec{f}_{abcs}$$

$$\vec{f}_{abcs} = [f_{as} \quad f_{bs} \quad f_{cs}]^T$$

$$\vec{f}_{qd0s} = [f_{qs} \quad f_{ds} \quad f_{0s}]^T$$



# Stacionarni koordinatni sistem

## Matrice transformacije statorskih veličina

$$\mathbf{K}_s = \frac{2}{3} \cdot \begin{bmatrix} 1 & -0,5 & -0,5 \\ 0 & -\frac{\sqrt{3}}{2} & \frac{\sqrt{3}}{2} \\ 0,5 & 0,5 & 0,5 \end{bmatrix}$$

$$\mathbf{K}_s^{-1} = \begin{bmatrix} 1 & 0 & 1 \\ -0,5 & -\frac{\sqrt{3}}{2} & 1 \\ -0,5 & \frac{\sqrt{3}}{2} & 1 \end{bmatrix}$$

# Šema energetskeg pretvarača pogona sa asinhronim motorom

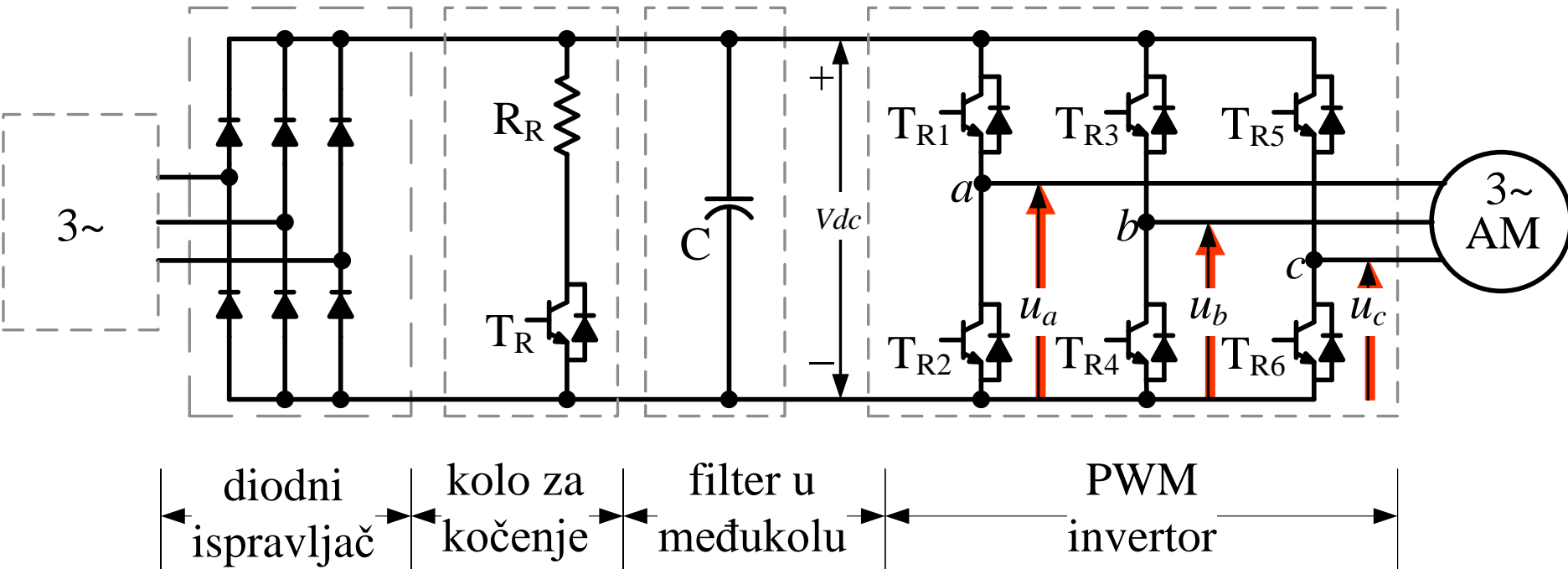

$u_a, u_b, u_c$  ↑  
Ponencijal u odnosu na negativnu šinu jednosmernog međukola

# Vrednosti potencijala $u_a$ u funkciji stanja prekidača u grani $a$

T1

$u_a$	Tranzistor $T_{R1}$	Tranzistor $T_{R2}$	Stanje $S_a$
$V_{dc}$	uključen	isključen	1
0	isključen	uključen	0

# Definicije napona i struja motora u stacionarnom koordinatnom sistemu

Međufazni naponi računati pomoću potencijala prema negativnoj šini jednosmernog međukola:

$$u_{ab} = u_a - u_b$$

$$u_{bc} = u_b - u_c$$

$$u_{ca} = u_c - u_a$$

Fazni naponi u odnosu na zvezdište motora:

$$u_{as} = \frac{u_{ab} - u_{ca}}{3}$$

$$u_{bs} = \frac{u_{bc} - u_{ab}}{3}$$

$$u_{cs} = \frac{u_{ca} - u_{bc}}{3}$$

Naponi motora u stacionarnom koordinatnom sistemu:

$$u_{qs} = u_{as}$$

$$u_{ds} = \frac{1}{\sqrt{3}} (u_{cs} - u_{bs}) = \frac{1}{\sqrt{3}} u_{cb}$$

Struje motora u stacionarnom koordinatnom sistemu:

$$i_{qs} = i_{as}$$

$$i_{ds} = \frac{1}{\sqrt{3}} (i_{cs} - i_{bs})$$

Uvažen je koeficijent 2/3 u transformaciji.

# Izlazni naponi invertora u skladu sa odgovarajućim stanjima prekidača

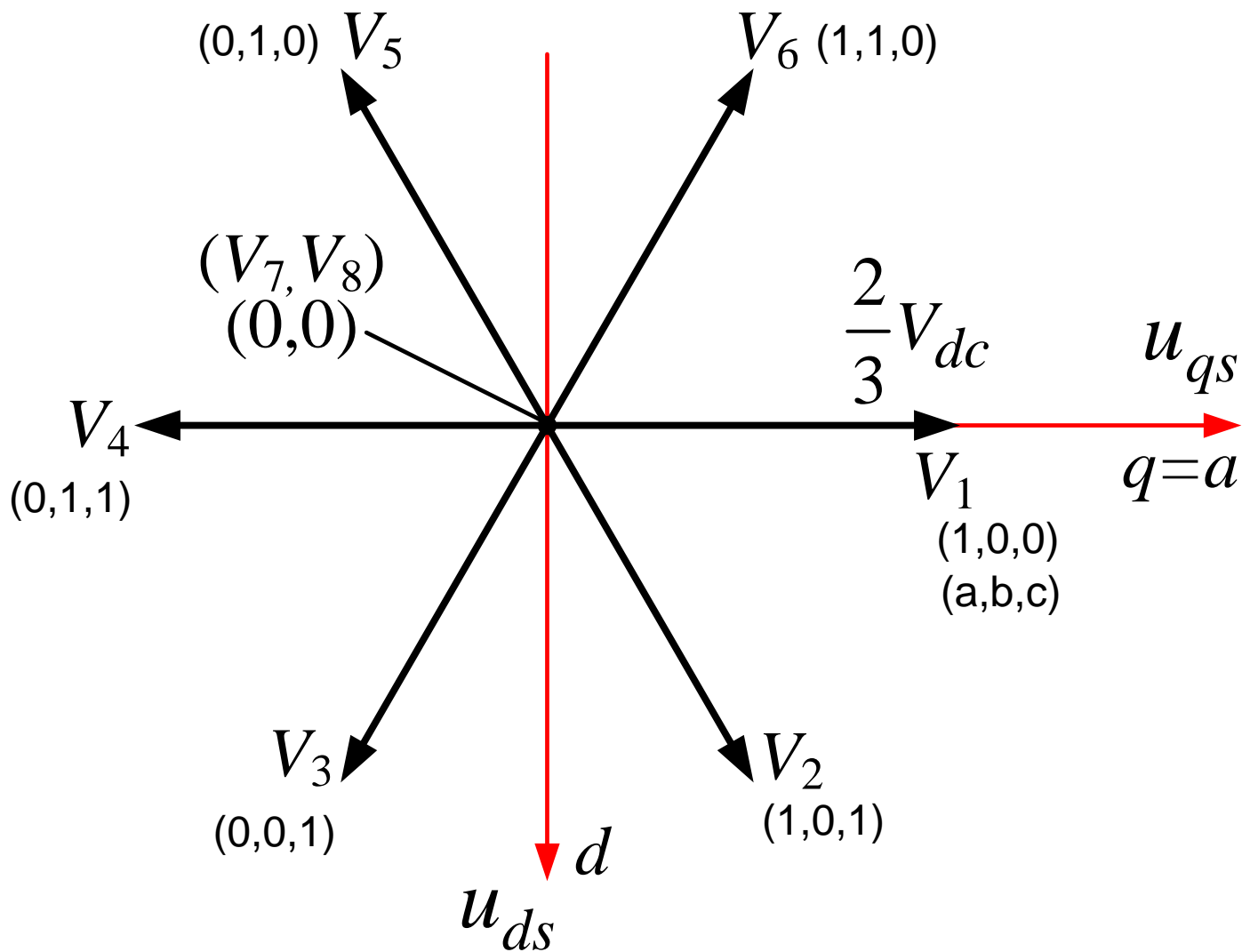

# Prikaz napona i struja u stacionarnom koordinatnom sistemu

Mala efektivna vrednost napona

Velika efektivna vrednost napona

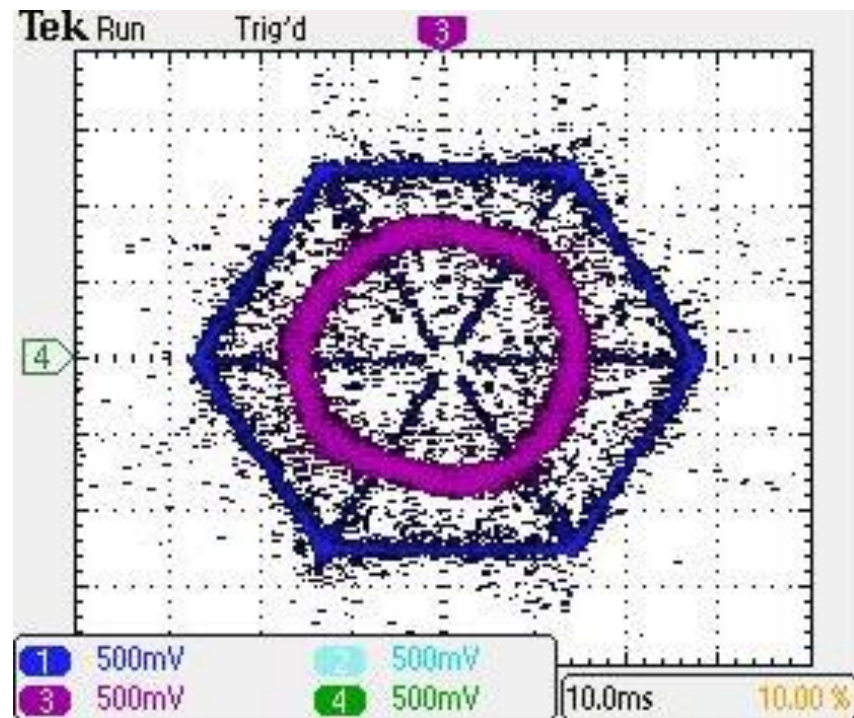
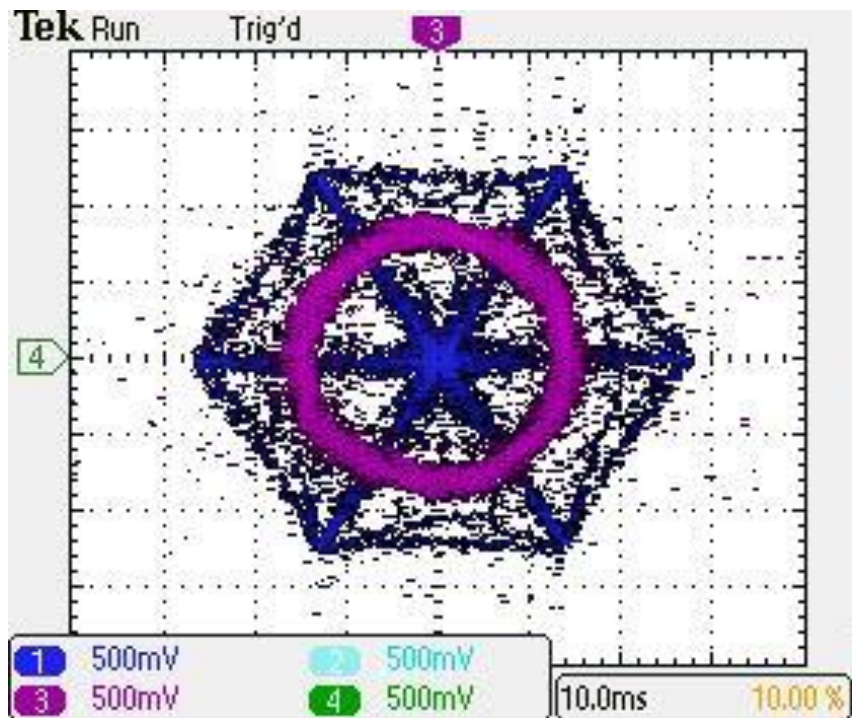

Napon ———  
Struja ———



# Izračunavanje vektora fluksa (intenziteta i ugla)

Integracija naponskih jednačina

$$\varphi_{qs} = \int (u_{qs} - R_s \cdot i_{qs}) dt = \int e_{qs} dt$$

$$\varphi_{ds} = \int (u_{ds} - R_s \cdot i_{ds}) dt = \int e_{ds} dt$$

$$\varphi_s = \sqrt{\varphi_{qs}^2 + \varphi_{ds}^2} \quad \theta_{\varphi_s} = \operatorname{tg}^{-1} \left( \frac{\varphi_{qs}}{\varphi_{ds}} \right) \Big|_{\varphi_{ds} \neq 0}$$

$$\cos \theta_{\varphi_s} = \frac{\varphi_{ds}}{\varphi_s} \quad \sin \theta_{\varphi_s} = \frac{\varphi_{qs}}{\varphi_s}$$



# Podela na sektore za identifikaciju položaja statorskog fluksa

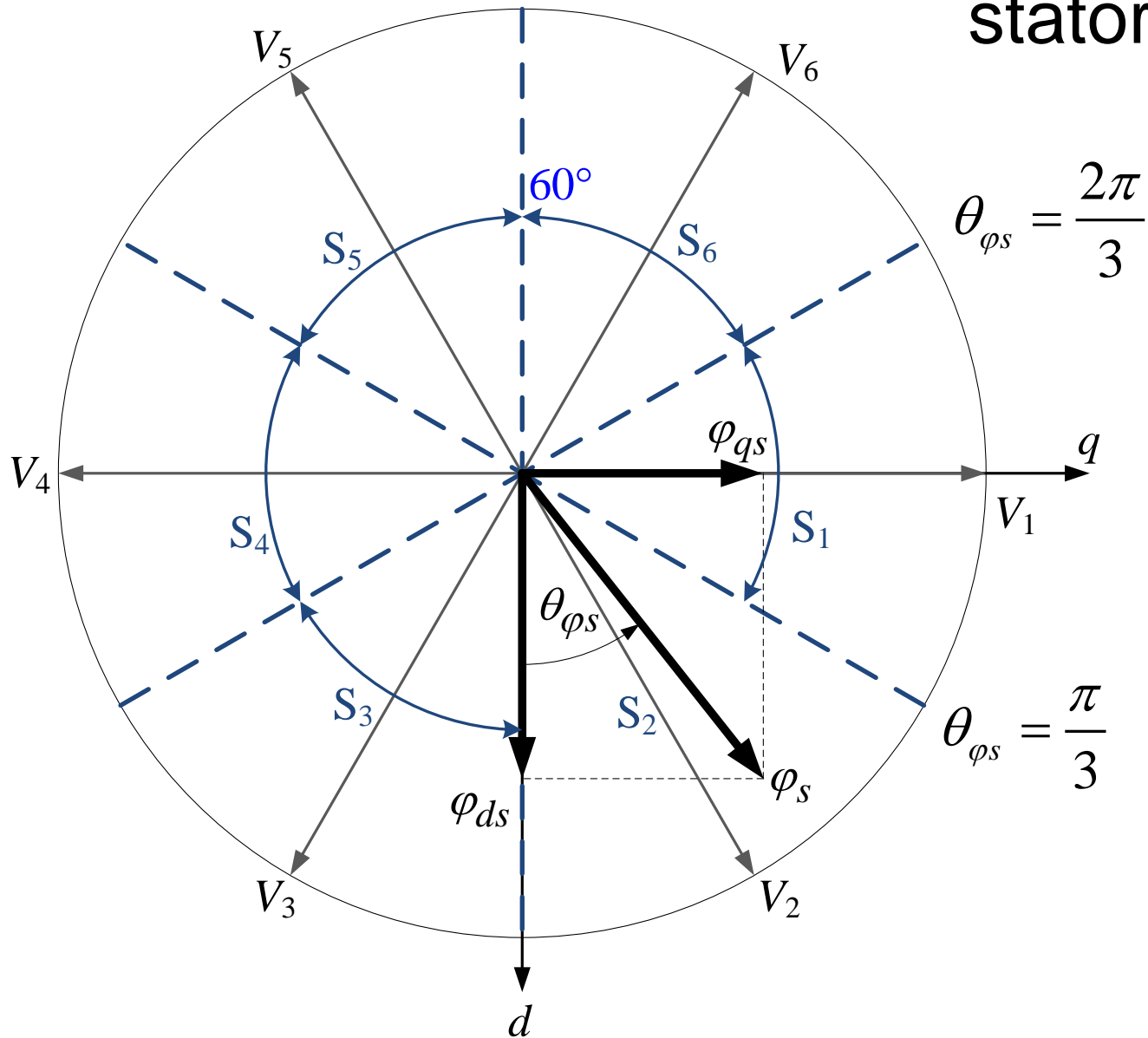

# Ugao $\theta_{\varphi s}$ definisan u odnosu na $d$ -osu

Ugao $\theta_{\varphi s}$	$S_{\theta}$
$0 \leq \theta_{\varphi s} < \frac{\pi}{3}$	2
$\frac{\pi}{3} \leq \theta_{\varphi s} < \frac{2\pi}{3}$	1
$\frac{2\pi}{3} \leq \theta_{\varphi s} < \pi$	6
$\pi \leq \theta_{\varphi s} < \frac{4\pi}{3}$	5
$\frac{4\pi}{3} \leq \theta_{\varphi s} < \frac{5\pi}{3}$	4
$\frac{5\pi}{3} \leq \theta_{\varphi s} < 2\pi$	3

# Drugi način određivanja sektora u kom se nalazi statorski fluks

T3

$\varphi_{ds}$	$\varphi_{qs}$	$S_\theta$
$\varphi_{ds} > \frac{1}{2}\varphi_s$	$\varphi_{qs} > 0$	2
	$\varphi_{qs} \leq 0$	3
$-\frac{1}{2}\varphi_s \leq \varphi_{ds} \leq \frac{1}{2}\varphi_s$	$\varphi_{qs} > 0$	1
	$\varphi_{qs} \leq 0$	4
$\varphi_{ds} < -\frac{1}{2}\varphi_s$	$\varphi_{qs} > 0$	6
	$\varphi_{qs} \leq 0$	5

$\varphi_s$  uvek ima pozitivnu vrednost

# Prekidačke logike za fluks i moment

Odnos fluksa prema zadatoj vrednosti	Prekidačka fun. $S_\varphi$
$\varphi_s < \varphi_s^*$	1
$\varphi_s \geq \varphi_s^*$	0

T5

Odnos momenta prema zadatoj vrednosti	Prekidačka fun. $S_m$
$(m_e - m_e^*) > \Delta m_e$	1
$-\Delta m_e \leq (m_e - m_e^*) \leq \Delta m_e$	0
$(m_e - m_e^*) < -\Delta m_e$	-1

T6

# Komparatori fluksa i momenta

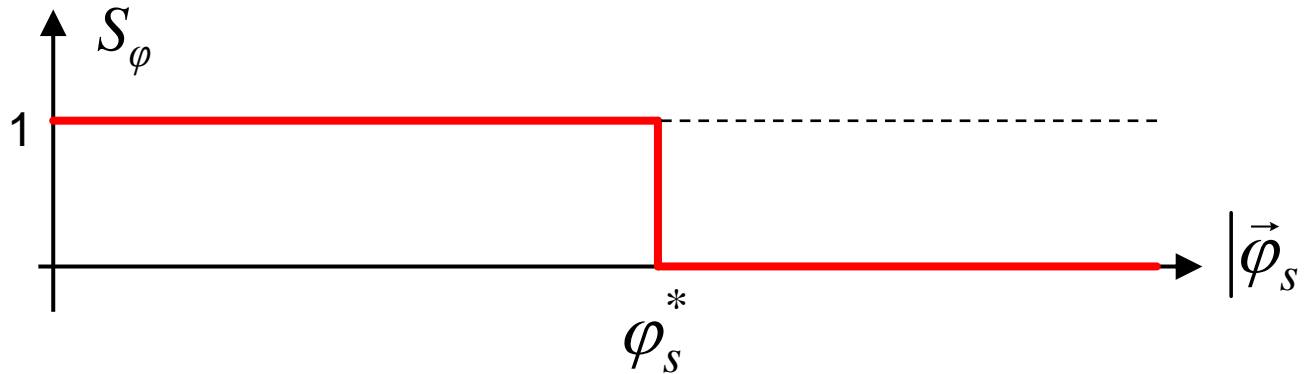

T5

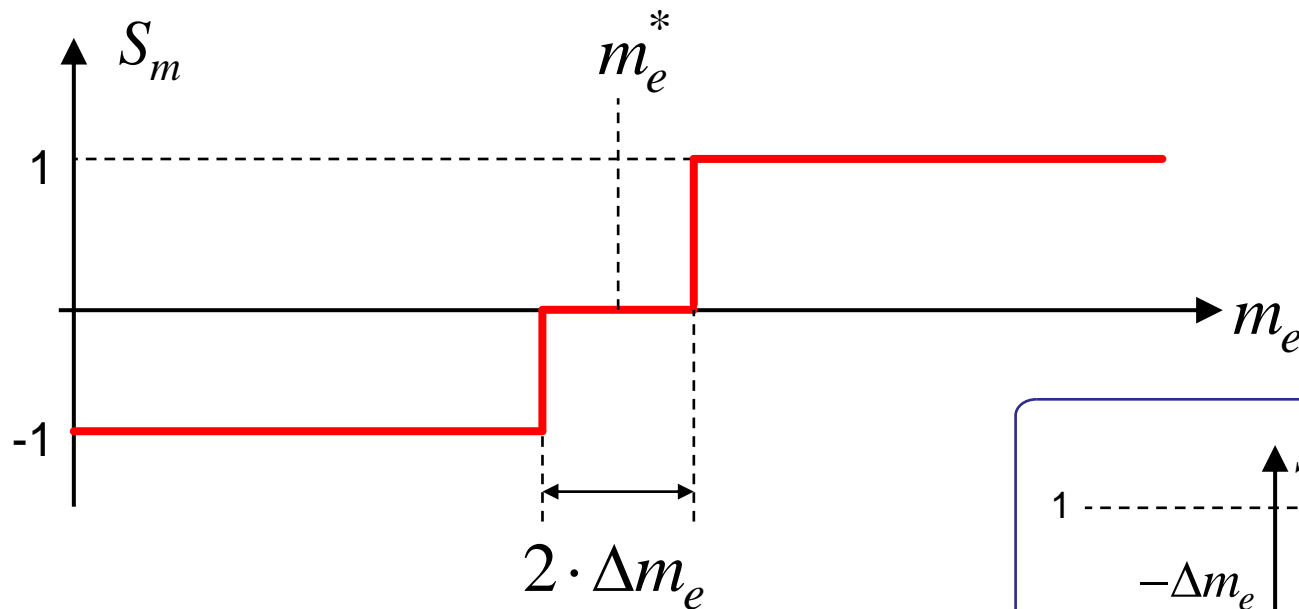

T6

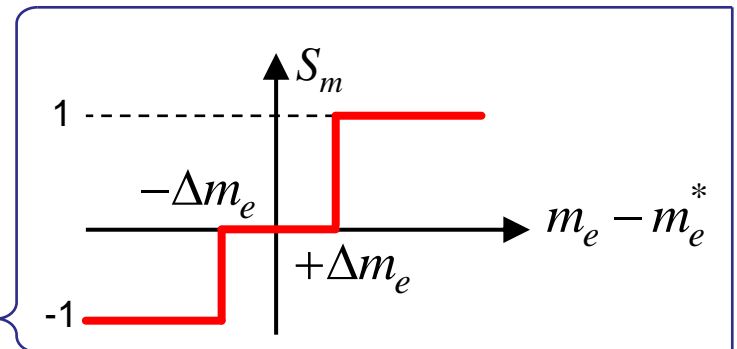

Prikaz kao u tabeli na prethodnom slajdu

# Efekat uključenja naponskih vektora na fluks

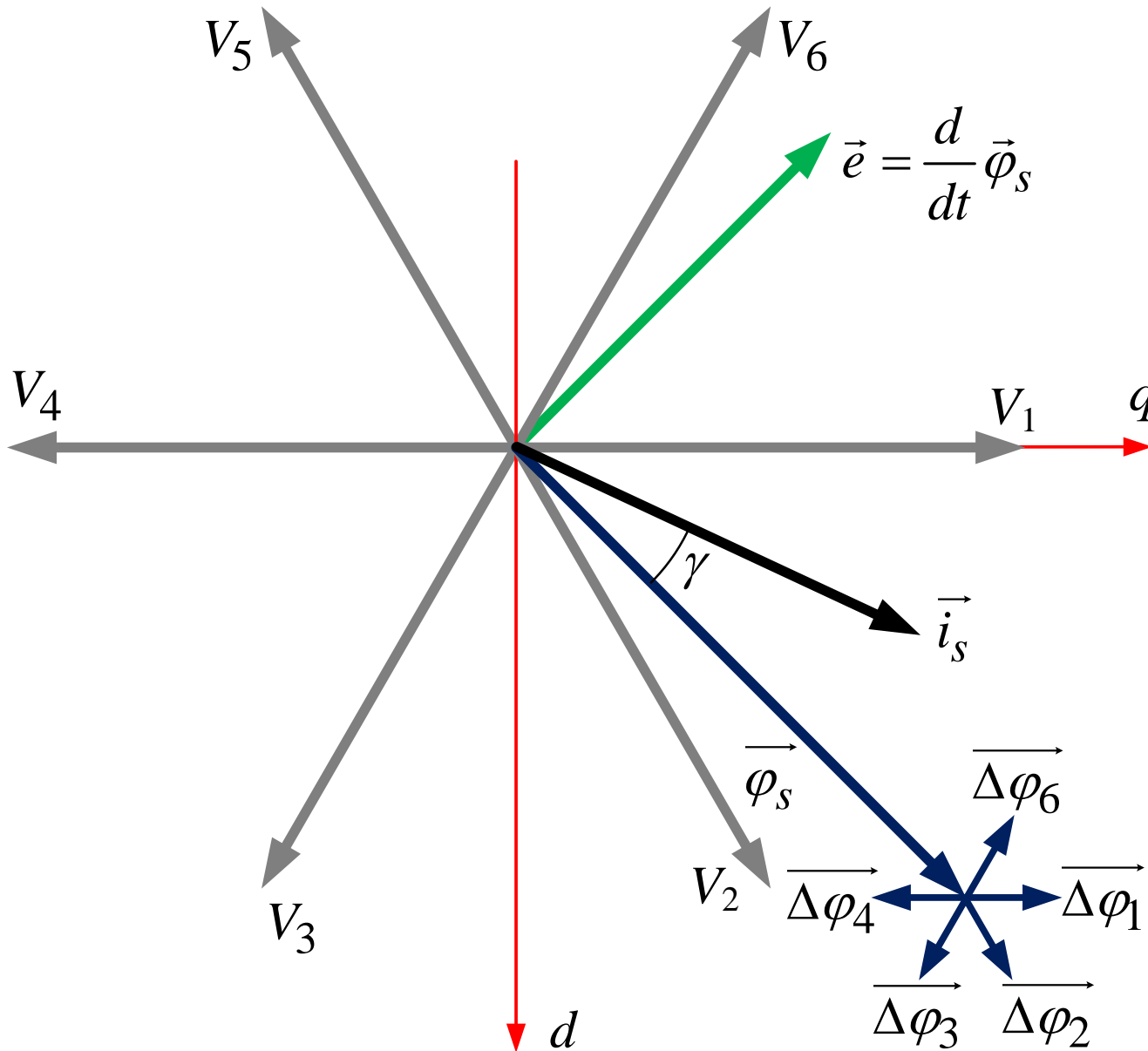

$$R_s \approx 0$$

$$\overrightarrow{\Delta\phi_1} \approx V_1 \cdot \Delta t$$

$$\overrightarrow{\Delta\phi_2} \approx V_2 \cdot \Delta t$$

$$\overrightarrow{\Delta\phi_3} \approx V_3 \cdot \Delta t$$

$$\overrightarrow{\Delta\phi_4} \approx V_4 \cdot \Delta t$$

$$\overrightarrow{\Delta\phi_6} \approx V_6 \cdot \Delta t$$

# Tabela upravljanja invertorom

T7

Prekidačke funkcije		$S_\theta$ – Sektor u kom se nalazi fluks					
$S_\varphi$	$S_m$	$S_1$	$S_2$	$S_3$	$S_4$	$S_5$	$S_6$
1	1	$V_6$	$V_1$	$V_2$	$V_3$	$V_4$	$V_5$
	0	$V_8$	$V_7$	$V_8$	$V_7$	$V_8$	$V_7$
	-1	$V_2$	$V_3$	$V_4$	$V_5$	$V_6$	$V_1$
0	1	$V_5$	$V_6$	$V_1$	$V_2$	$V_3$	$V_4$
	0	$V_7$	$V_8$	$V_7$	$V_8$	$V_7$	$V_8$
	-1	$V_3$	$V_4$	$V_5$	$V_6$	$V_1$	$V_2$

# Implementacija DTC upravljanja

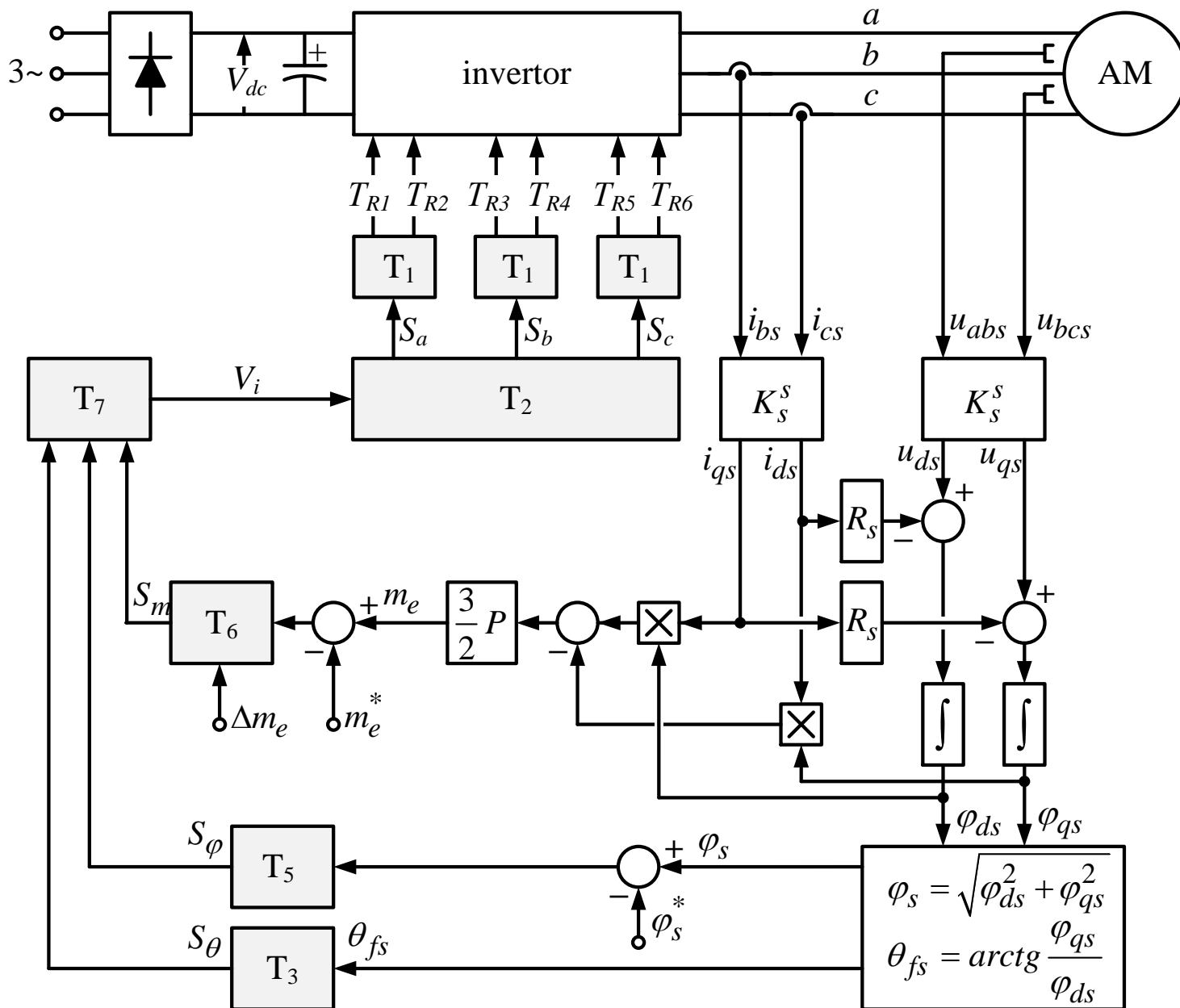



# Regulisani elektromotorni pogon sa direktnom kontrolom momenta

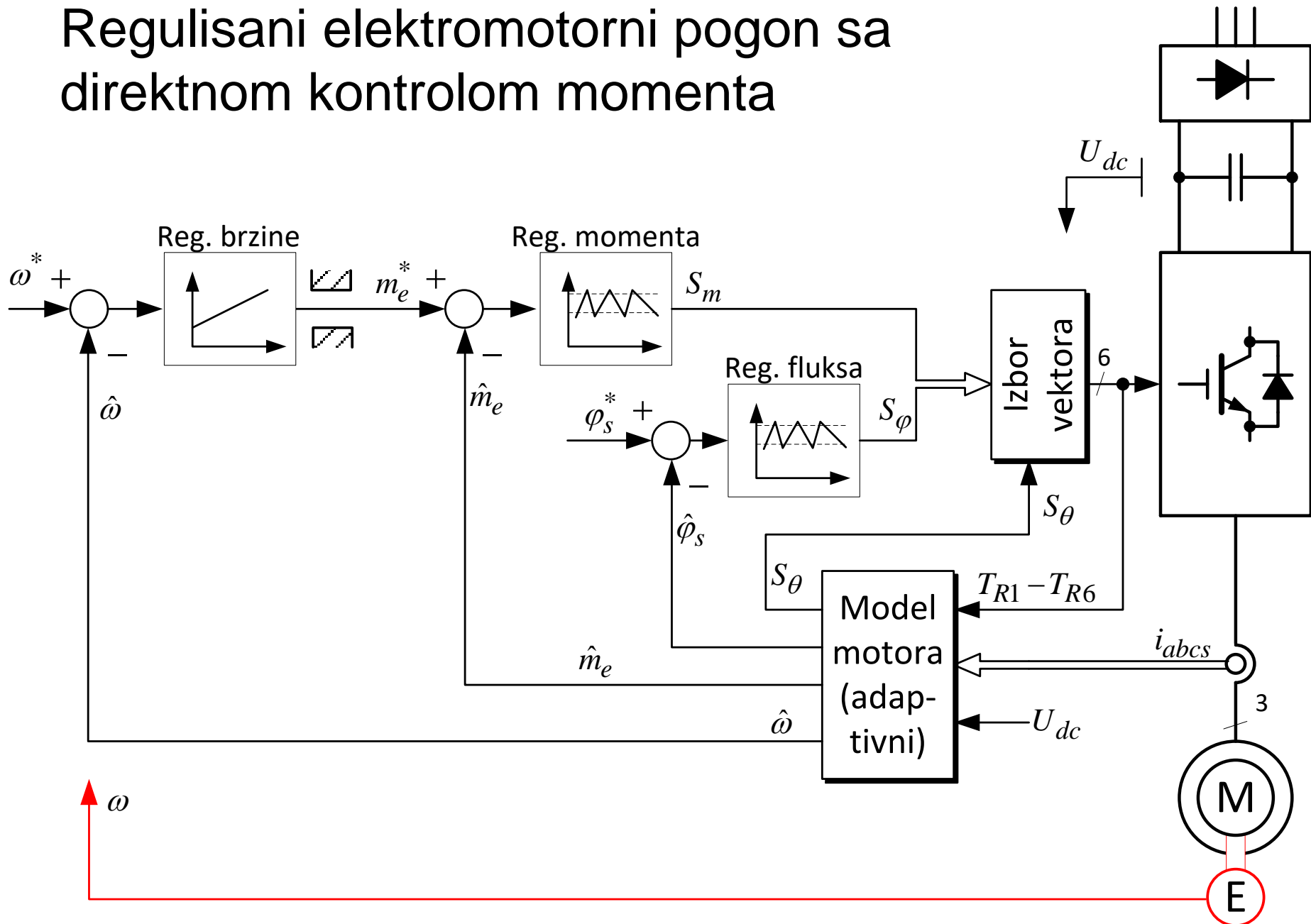

# Rad u proširenom opsegu brzina (slabljenje polja)

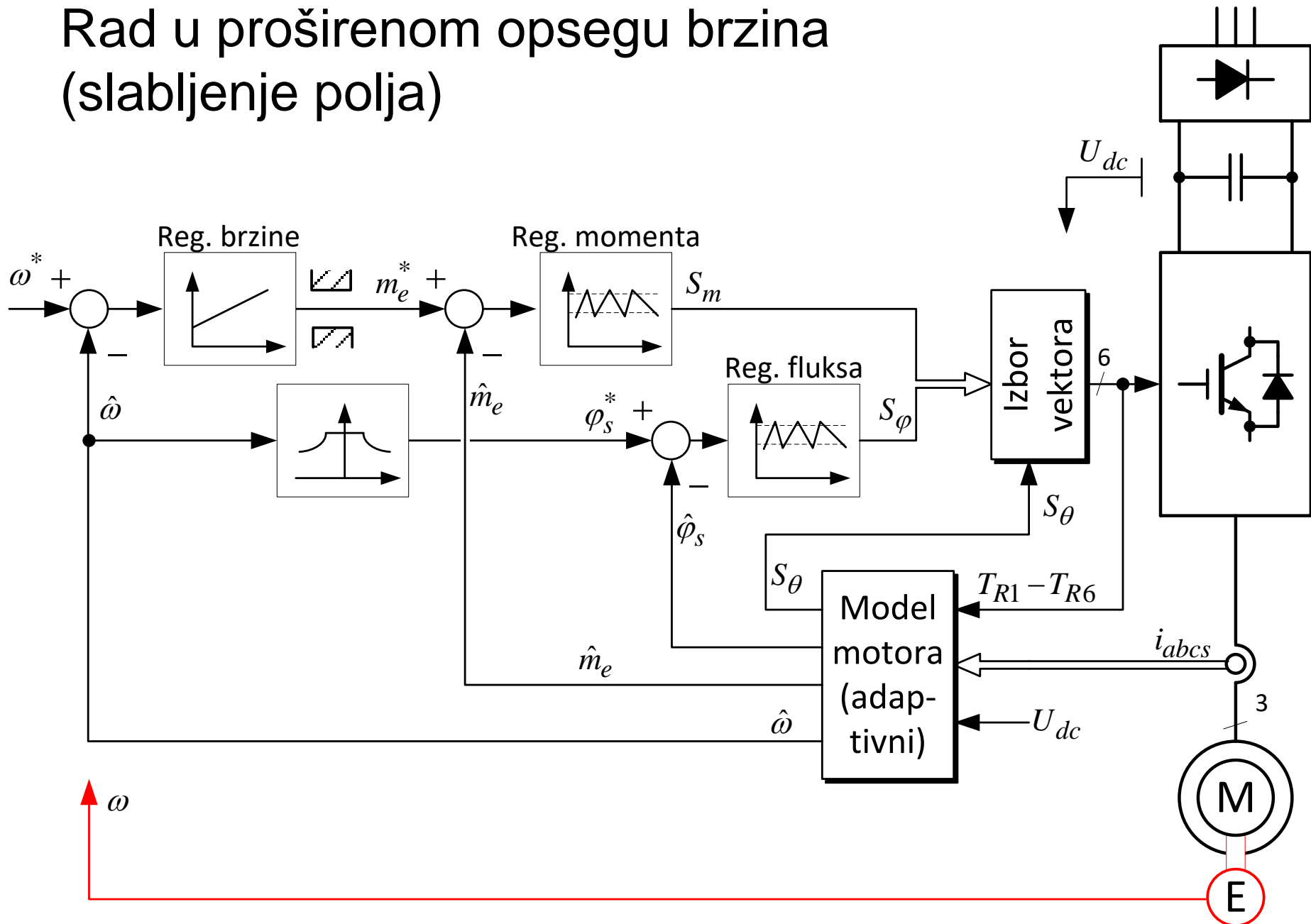

# Poděšavanje parametara regulatora brzine

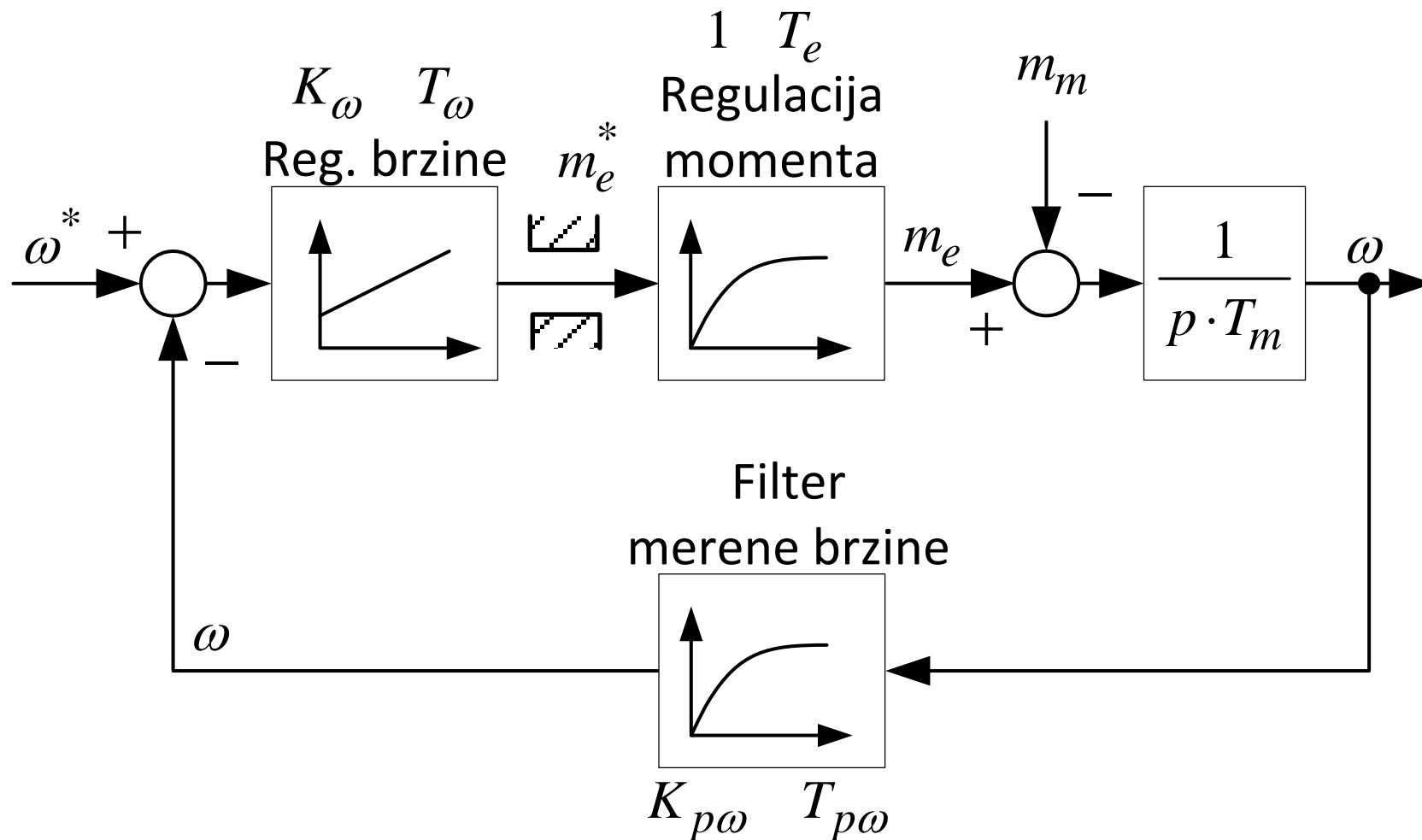

$T_e$  – Vreme uspona momenta na zadatu naglu poromenu referentne vrednosti (step komandu) – **od 1 do 5 ms**

# Poděšavanje parametara regulatora brzine

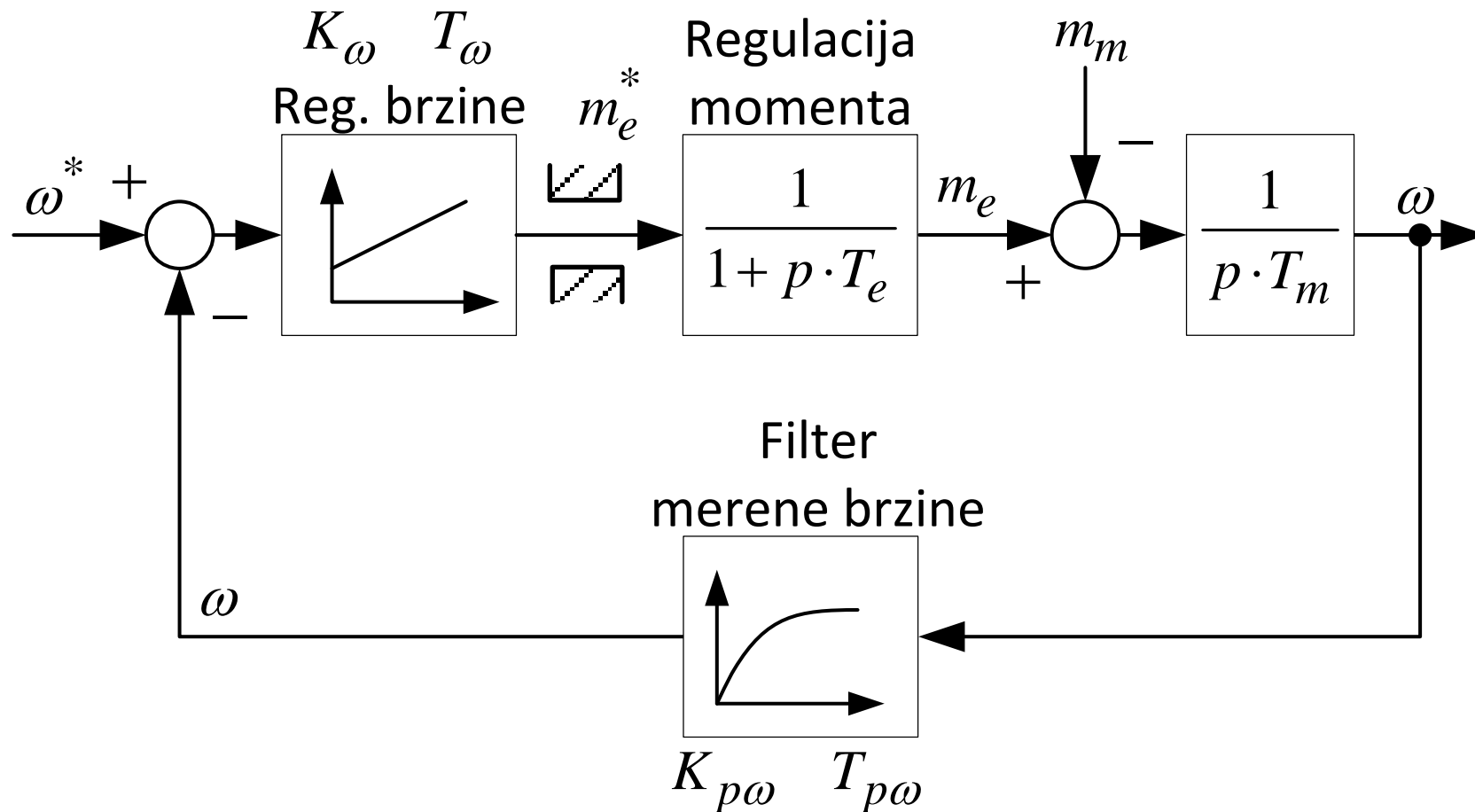

Može se primeniti simetrični optimum.  
Parametre regulatora brzine diktira aplikacija.

# Karakteristike

- Direktno upravljanje fluksom i momentom.
- Indirektno upravljanje strujom motora (nema regulatora struje).
- Približno sinusne statorske struje i statorski fluks.
- Vrlo brz odziv momenta.
- Učestanost komutacije invertora zavisi od širine histerezisa u komparatorima.

# Prednosti

- Koristi se stacionarni referentni sistem, nema obrtne transformacije.
- Ne koristi se IŠM (PWM) blok, direktno se zadaju stanja prekidača u inverteru.
- Minimalno vreme odziva momenta.
- Jednostavni regulatori (histerezisni) sa tabelarnim implementacijama.
- Manji broj izračunavanja u odnosu na vektorsko upravljanje.
- Manji broj parametara motora se koristi u algoritmu.

# Nedostaci klasične implementacije DTC algoritma

- Odsustvo regulatora struje može dovesti do problema sa velikim trenutnim vrednostima struje.
- Tokom uspostavljanja fluksa u mašini (magnetizacije) se mora koristiti drugi algoritam.
- Potrebni estimatori fluksa i momenta, koji zavise od parametara (samo od  $R_s$ ) motora.
- Promenljiva učestanost komutacije invertora.
- Veće odstupanje momenta od zadate vrednosti (veći ripl).

# Prevazilaženje nedostataka

## Nedostaci:

- Problemi sa velikim trenutnim vrednostima struje. ✓ Struja se može ograničiti primenom nultog vektora – u algoritam se ugrađuje zaštitna funkcija koja ograničava struju.
- Tokom magnetizacije se mora koristiti drugi algoritam. ✓ Malom modifikacijom tabele se može postići da isti algoritam radi i tokom uspostavljanja fluksa. Tokom magnetizacije ne dozvoljava se komanda momenta, nema rotacije motora.
- Potrebno poznavanje parametara motora ( $R_s$ ). ✓ Parametri motora se određuju veoma precizno prilikom puštanja pogona u rad. Otpor statora je veličina koja se može odrediti i u toku rada pogona.
- Promenljiva učestanost komutacije invertora. ✓ U digitalnim implementacijama algoritam se izvršava periodično, pa se i promena stanja invertora dešava periodično. Manji broj komutacija (promena stanja) nego sa IŠM (PWM) modulacijom.
- Veći ripl momenta. ✓ Ripl zavisi od širine histerezisa i od učestanosti izvršavanja algoritma. Radi se na modifikacijama algoritma koje će smanjiti ovaj problem.



# Za one koji žele više...

- Laboratorijske vežbe – Praktikum
  - **Regulisani pogon sa direktnom kontrolom momenta asinhronog motora**
- Seminarski rad  
(uz podršku nastavnika i literature)
- Energetski efikasni elektromotorni pogoni (MS)
- Odabrana poglavlja iz elektromotornih pogona (MS)
- Literatura