

Catalog | Freelance 2016

# Freelance DCS Product Catalog

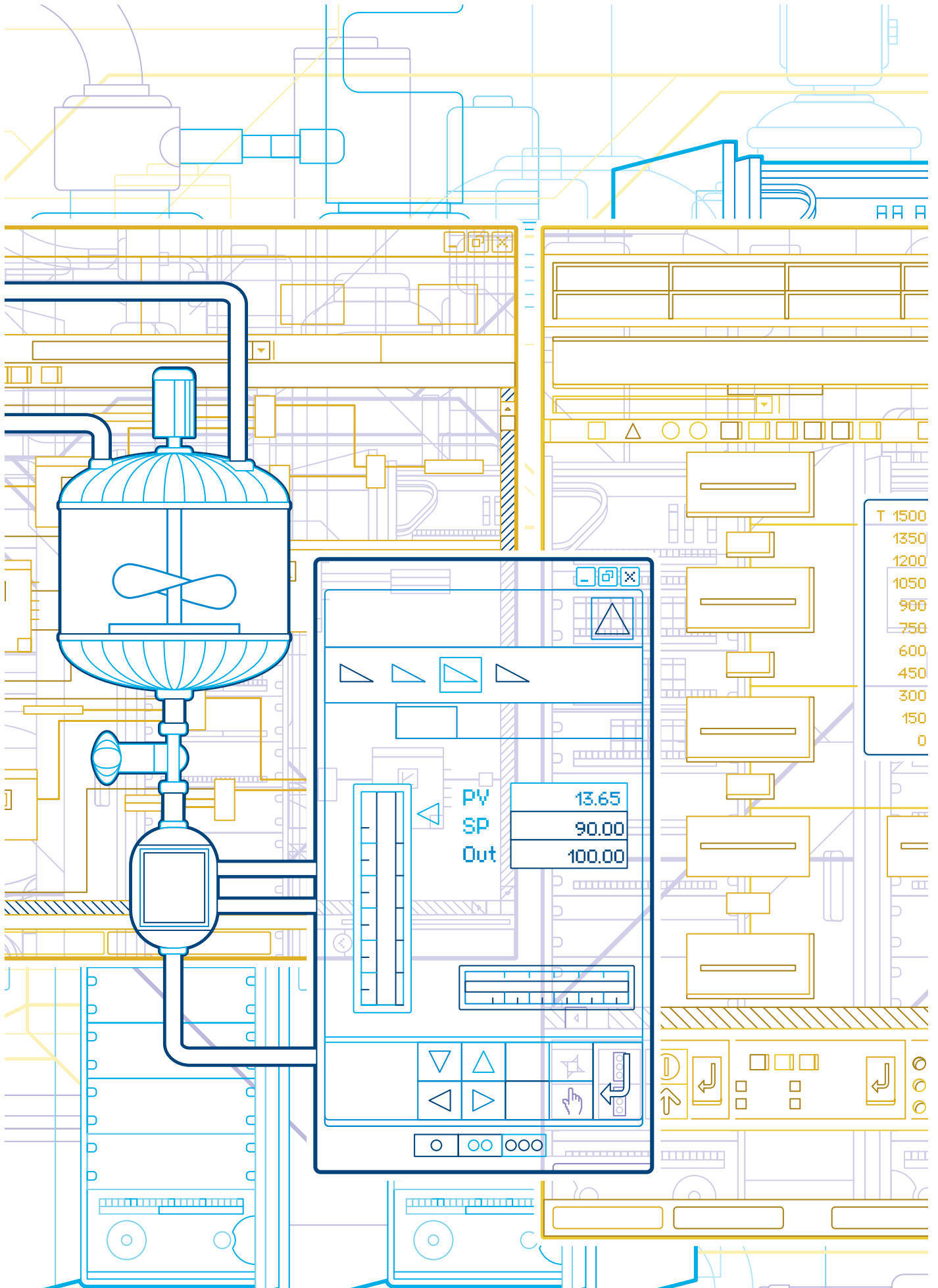

T 1500  
1350  
1200  
1050  
900  
750  
600  
450  
300  
150  
0

Control Panel Interface:

- Navigation icons: left, right, up, down triangles.
- Process Variable (PV): 13.65
- Setpoint (SP): 90.00
- Output (Out): 100.00
- Control elements: a vertical bar chart, a horizontal bar chart, and a set of directional arrows.
- Bottom status indicators: three circles of varying sizes.

# Freelance Distributed Control System – Product Catalog

## Table of contents

Chapter 1 – Introduction	1
Chapter 2 – System architecture	2
Chapter 3 – The controllers AC 900F, AC 800F, AC 700F	3
Chapter 4 – Power Supplies for AC 900F, AC 700F and S700 I/O	4
Chapter 5 – I/Os: S700, S800, S900	5
Chapter 6 – Fieldbus network components and Profibus configuration for S700	6
Chapter 7 – Freelance Operations	7
Chapter 8 – Freelance Engineering	8
Chapter 9 – Media and documentation	9
Chapter 10 – Add-ons, extensions, and service	10
Chapter 11 – Index	11
Appendix A – Notes	A

# Chapter 1 – Introduction

1



**Freeland is ABB's user-friendly, cost-effective and robust solution ideal for nearly all process industries with the following benefits:**

- **Easy to use:** It is very easy to install, learn, engineer, commission, back-up, maintain and expand.
- **Scalable:** Projects can start as small as a few I/Os for skids, package units or single plant equipment and grow to thousands of I/Os controlling the whole plant.
- **Reliable:** It is a proven system with high reliability and availability providing redundancy options supporting solutions without any single point of failure.
- **Value for your money:** Investment goes a long way because of its small footprint and ability to run on any standard computer. Together with its ease of use, this results in savings in installation, engineering, commissioning and life cycle costs

## **Freeland version 2016**

Thousands of installations and still more benefits? Sure. With the latest AC 900F controller, the Freeland DCS provides significant improvements in all areas: availability, scalability, usability, connectivity.

Freeland version 2016: Benefits at a glance:

- Compatible with previous versions of Freeland components
- New Profibus Master module with built-in redundancy
- Improved availability through control network redundancy
- Increased security through controller lock
- Enhanced scalability through AC 900F Lite and Freeland Operations Lite
- Modbus RTU, Modbus TCP, Telecontrol IEC 60870-5-101 and Telecontrol IEC 60870-5-104 for ABB's AC 700F, AC 800F and AC 900F controllers
- New CAN bus module for AC 900F to connect Freeland Rack I/O

## Easy to use

Freelance can be installed on any standard computer and in just a few minutes. A Quickstart Tutorial is available, which allows users to learn at their own pace with detailed instructional videos. It takes less than a week to learn since there is just one engineering tool. Pre-engineered, ready-to-use displays make engineering much easier compared to other control systems or PLC/SCADA combinations. Additionally, a system-wide project database makes archiving or backup very easy to perform. There is also multiple language support.

The Freelance control system combines user-friendly engineering with an open, modern system architecture. This means:

- Only one tool for engineering, commissioning and diagnostics
- Fieldbus management completely integrated into control system engineering
- Time and cost savings in engineering, commissioning, testing, service and maintenance
- Assembly close to the field: reduction of field wiring and space requirements
- Freelance has a convenient cross-reference feature allowing variables and tags to be found easily in any editor right up to the graphic display. This makes troubleshooting and debugging easier, resulting in faster project execution.

### Pre-configured components for the operator level

The engineering of the Freelance operator level is straightforward. The pre-configured visualization components include:

- Faceplates
- Module diagnostics
- Extended troubleshooting capabilities
- Automatically generated SFC displays
- Automatically generated system communication
- Event list, alarm line and message log files
- Trend displays with long-term archiving

These components can be used straight out of the box, eliminating time-consuming manual configuration.

## Reliable

Freelance is a well-proven technology that has been around for more than 20 years and is installed in thousands of installations globally since its origination in Germany.

### High availability

The technology has proven its worth in industrial use over several years and meets the toughest requirements regarding availability. The hardware can be structured redundantly at all levels. This includes the redundant fieldbus modules, redundant fieldbus lines as well as network and controller redundancy.

### Regulatory compliance

With a view to meeting the requirements of regulatory authorities such as the American FDA (Food and Drug Administration) or the EFSA (European Food Safety Authority), Freelance provides a series of features that facilitate the validation procedure. Examples include:

- Encrypted log and trend data
- Audit trail functions
- Access rights and user administration (security lock)

## Scalable

Freelance can be easily scaled up from a small system of a few I/Os to a large system of up to thousands of I/Os. Expansion can be done with minimal engineering effort. All controller types can be used in combination in a single system. They are suitable both for installation in the control room and for use in junction boxes directly in the field.

- The AC 700F controller has a small footprint that supports PROFIBUS. It can support up to eight direct I/O modules.
- The AC 800F controller can be equipped with up to four fieldbus modules of type serial, PROFIBUS, FF HSE or Freelance CAN bus. Optionally, AC 800F supports redundancy.
- The AC 900F controller also supports PROFIBUS and Freelance CAN bus and truly extends the hardware portfolio of the Freelance distributed control system. The AC 900F modular controller offers expanded flexibility via a pluggable SD card, more Ethernet ports, redundancy options for high availability and power enough for around 1,500 I/Os per controller. A Lite version is available, optimized for smaller applications.

The new lite version of Freelance Operations also provides for enhanced scalability of the system on the operator level.

## Value for your money

The big advantage of Freelance is the savings it provides in project engineering.

The easy-to-use features and use of only one tool for configuration of graphics, controllers and field devices allows engineering and commissioning time to be reduced, resulting in faster start-ups.

Freelance has a small footprint (comparable to a PLC), which means less space requirement for cabinets. Since the system uses intelligent peer-to-peer architecture, there is no need for expensive server PCs.

In fact, Freelance can run on any standard computer with minimum specifications. It is installed in just a few minutes.



# Chapter 2 – System architecture

- 2.1 Operator level .....6
- 2.2 Engineering tool.....6
- 2.3 Process level .....6
- 2.4 System communication .....7
  - 2.4.1 Control network .....7
  - 2.4.2 OPC .....8
  - 2.4.3 Advanced application programming DMS-API .8
  - 2.4.4 Technical details of the control network. ....8

Freelance provides both, operator level and process level. The operator level contains the functions for operation, process monitoring, archives and logs, trends and alarms. Open- and closed-loop control functions are processed in the controllers which communicate with actuators and sensors in the field.

## 2.1 Operator level

The Freelance Operations station is a software that runs on a simple PC-environment under Microsoft Windows. It installs in five minutes. Freelance Operations supports dual-monitor operation, which offers the benefit to stay continuously tuned with essential information like the alarm list, while inspecting at the same time for example the progress of a sequential function chart, trend archives, or the system display with extended diagnostics. In a plant, several Freelance Operator Workplaces can work seamlessly together.

The extended automation functionality of ABB's System 800xA can be utilized for Freelance as well by utilizing the "800xA for Freelance" connectivity package. This way you can concentrate several Freelance systems under one common operator console in parallel to the existing operator stations.

## 2.2 Engineering tool

The Freelance engineering station is used to configure and commission the whole system including the controllers, field devices and Freelance Operations. Usually, portable equipment such as laptops, which allow configuration both in the office and on site, is used. The operator level PCs can also be used for system engineering. A permanent connection to the engineering station is not necessary.



## 2.3 Process level

A Freelance system can consist of one or combination of several AC 700F, AC 800F and/or AC 900F controllers. It can be connected to field devices through fieldbuses, direct and remote I/Os.

With the AC 800F and AC 900F controllers, you have the option of configuring your entire system in redundancy.

As shown in the architecture drawing (see "Figure 1: Freelance System Architecture" on page 7), Freelance can go from a typical OEM offering with an AC 700F controller, a Panel 800 and around 50-100 I/Os. The AC 700F can have up to eight direct I/O modules connected to it or have remote I/Os connected via PROFIBUS. Modbus RTU and TCP are also supported. The Freelance Lite offering can typically have an AC 700F or AC 900F controller and will be in the 250 to 400 I/O range with possibly a combination license and a few operator stations. This can ramp up to the Freelance Standard and Premium offerings with the AC 800F and/or AC 900F, with or without redundancy. Freelance can go up to thousands of I/Os. Connections include Foundation Fieldbus, PROFIBUS and Hart as well. There is also the possibility to connect to supervisory control stations running on ABB's 800xA system.

Integration of 3rd party PLCs like Safety PLCs or package units can easily be achieved by using the new OPC based "PLC Integration" functionality of Freelance. This not only provides the ability read or write data, but also to create faceplates based on existing Freelance ones to interact with those units and to integrate the alarms into the Freelance alarm management.





## 2.4 System communication

The operator and the process level communicate via the control network, which is based on Standard Ethernet. You can choose between various transmission media such as twisted pair or fiber optic cable. The system components use a specific protocol called DMS, which is an enhanced MMS (Machine Message Specification) protocol. This protocol can be utilized by 3rd party network subscribers using the application interface DMS-API. This is a „C“ programming interface for MS Windows to enable programmers to create tailored solutions. A more standardized and generic approach to connect to the system is provided by the Freelance OPC server to access real-time process values (DA) and alarms/ events (AE) from the Freelance System.

A Freelance system in theory can have up to 100 controllers and 100 operator stations. However - the majority of the systems are in the range of 1 to 5 controllers/ operator stations. Each controller can communicate to a total of 10 Freelance operator stations, OPC- or trend servers. If the number of those exceeds 10, the system allows to segment the data communication accordingly per simply setting some check marks.

**Note:** a Freelance operator station or the Freelance OPC-server can “talk” to more than 10 controllers. So, if the number of controllers exceed 10, there is no further action required.

## 2.4.1 Control network

The control network connects the controllers, operator stations and engineering station in the Freelance system. The control network complies with the Ethernet Standard according to DIN/ISO 8802, Part 3 (IEEE 802.3) and can be used with twisted pair or coaxial cable. It is also possible to use a combination of these standards or to implement 1-GBit/s components within a network as high-speed backbone. Freelance uses confirmed and unconfirmed services. The unconfirmed UDP service is used for screen updating and lateral communication between controllers. The confirmed TCP/IP service is used for alarming and trend archiving. The control network has the following features:

- The ability to cover long distances
- A high data throughput
- A flexible network layout
- Control Network redundancy

Figure 1: Freelance System Architecture

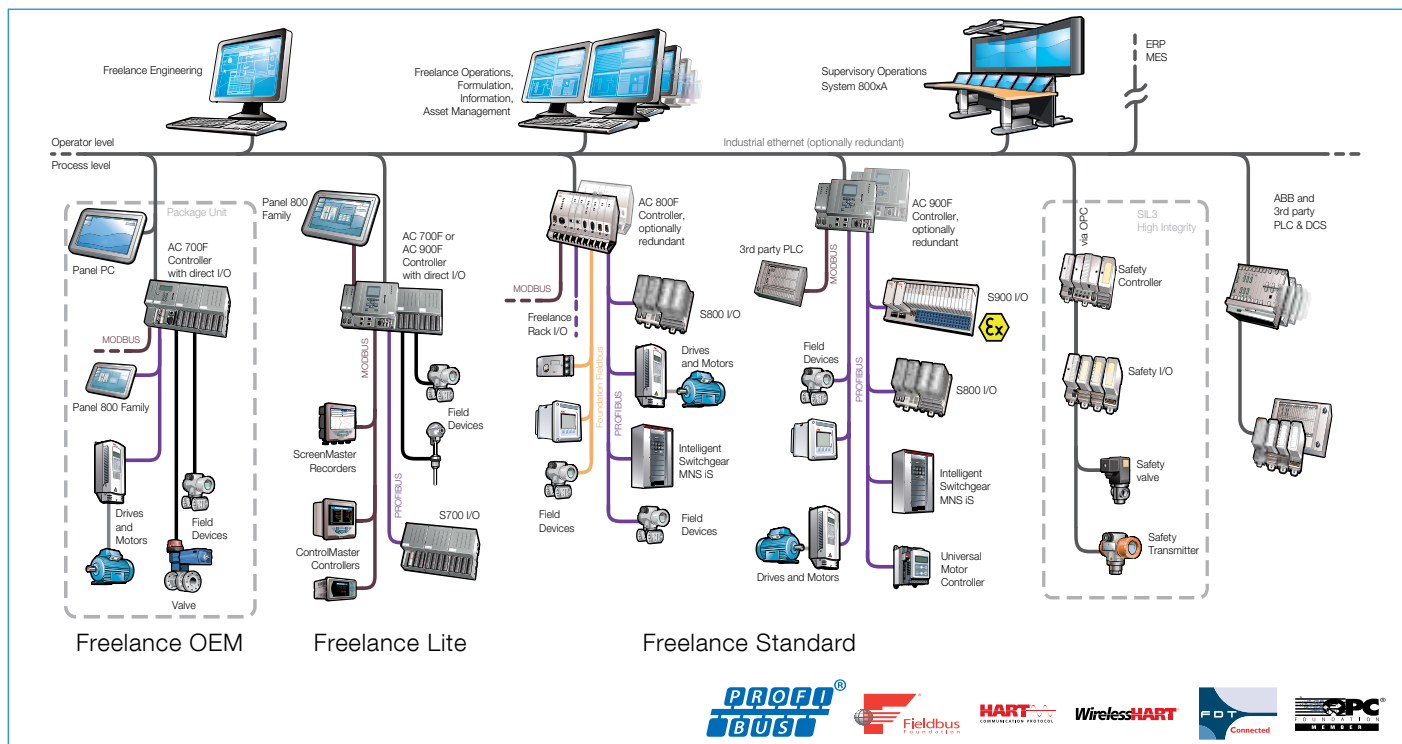

## 2.4.2 OPC

Freelance provides an OPC gateway (server), which allows OPC clients to access data and alarms from the Freelance controllers. The OPC server also allows access to the DPV1 parameters and user parameters of PROFIBUS and HART devices. In the case of HART devices, this is only possible if they are connected to an S900 remote I/O unit. For Freelance version 8.2 and higher, the parameters of FOUNDATION Fieldbus devices can also be accessed. It is possible to limit access to this data at the OPC gateway such that an OPC client cannot see certain tags and variables at all, can only read other tags and variables, or has both read and write access to certain tags and variables.

Freelance Operations has a built-in OPC client, which permits you to access data from external OPC servers. Using this, for example, data from third-party controllers with OPC support can be integrated into a custom graphic in Freelance Operations. Since Version 9.2, when using Freelance Operations PLC Integration, also Faceplate creation and Alarm & Events are supported.

As several OPC gateways can be used in the Freelance system, server redundancy can be established using OPC clients that support this function. The Freelance Engineering software supports this with the redundant OPC gateway configuration.

The trend server option provides a special OPC gateway that is used by the operator stations for user-defined trend displays. Access to the trend server is fixed to “read only”, and all trend variables are automatically available. There is one trend server per Freelance system.

## 2.4.3 Advanced application programming DMS-API

The DMS Application Programming Interface provides C programmers with a Windows interface through which they can access internal Freelance communications services. This enables them to create their own Windows applications that can read online data from the Freelance system and create values.

## 2.4.4 Technical details of the control network

Details of the control network		
Bus type:	Twisted Pair (TP)	Fiber optic (FL)
Max. length:	5 x 100 m 5 x 400 m for shielded TP	4500 m
Application:	Control network connection of Freelance operator stations (for operation and observation), engineering station and controllers	
Standard:	DIN/ISO 8802 Part 3 (IEEE 802.3) 10BASE-FL	DIN/ISO 8802 Part 3 10BASE-FL (IEEE 802.3)
Transmission rate:	10/100 MBit/s	10/100 MBit/s

# Chapter 3 – Controllers

- 3.1 Overview . . . . .10**
- 3.2 Functions . . . . .11**
- 3.3 The controller AC 900F . . . . .12**
  - 3.3.1 Hardware and certificates. . . . .12
  - 3.3.2 AC 900F redundancy concept . . . . .15
  - 3.3.3 Central processing unit PM 902F, standard . .16
  - 3.3.4 Central processing unit PM 901F, lite . . . . .18
  - 3.3.5 PROFIBUS Communication Interfaces . . . . .20
  - 3.3.6 CAN Communication Interface . . . . .22
  - 3.3.7 Accessories. . . . .25
- 3.4 The controller AC 800F . . . . .28**
  - 3.4.1 Hardware and certificates. . . . .29
  - 3.4.2 AC 800F redundancy concept . . . . .32
  - 3.4.3 AC 800F, pre-assembled stations . . . . .36
  - 3.4.4 AC 800F, base unit PM 803F . . . . .36
  - 3.4.5 Power supply. . . . .38
  - 3.4.6 Ethernet interface . . . . .42
  - 3.4.7 Fieldbus interface modules. . . . .44
  - 3.4.8 Coated and G3 compliant hardware . . . . .50
  - 3.4.9 Accessories. . . . .51
- 3.5 The controller AC 700F . . . . .54**
  - 3.5.1 Hardware and certificates. . . . .54
  - 3.5.2 Central processing unit PM 783F . . . . .56
  - 3.5.3 PROFIBUS module CI 773F . . . . .58
  - 3.5.4 CPU terminal base TB 711F . . . . .58
  - 3.5.5 Accessories for CPU module . . . . .60

# Controllers

## 3.1 Overview

Freelance comes with three different types of controllers, AC 700F, AC 800F and its latest Freelance controller – the AC 900F. This controller truly extends the hardware portfolio of Freelance distributed control system.



AC 900F



AC 800F



AC 700F

### AC 900F

- SD card support
- Typically around 1,500 I/Os supported with CPU PM 902F
- Up to 400 I/Os supported with CPU PM 901F (Lite)
- G3 compliant as standard
- Redundancy option for high availability
- AC 900F Standard (PM 902F): Four (4) built-in Ethernet ports supporting Modbus TCP or 60870-5-104 Telecontrol protocol
- AC 900F Lite (PM 901F): Three (3) built-in Ethernet ports supporting Modbus TCP or 60870-5-104 Telecontrol protocol
- Two (2) serial ports supporting Modbus RTU or IEC 60870-5-101 Telecontrol protocol
- Optional PROFIBUS master modules (up to two) providing integrated line redundancy
- Optional one CAN Bus communication interface for connection of Freelance Rack I/O
- Direct connection of I/O modules (as many as 10), including modules combining inputs and outputs in just one module can reduce footprint and costs.
- I/O modules can also be connected remotely via PROFIBUS

### AC 800F

- The outstanding feature is it can be equipped with a set of fieldbus modules, covering all major fieldbuses used in process automation.
- Option to run controllers either redundantly (CPU redundancy, fieldbus module redundancy) or non-redundantly.

- Fieldbus-compliant components such as remote I/O, field devices, and network components can be used.
- Optional G3-compliant
- A single controller can typically support around 1,000 I/Os

### AC 700F

- Typically supports around 300 I/O signals per AC 700F controller.
- This PLC-like controller comes with a very small footprint. As many as eight (8) S700 direct I/O modules can be plugged to the right of the controller module.
- The connection to the Freelance control network is via Ethernet as for all other controllers. As an alternative to remote I/Os, AC 700F can be placed directly in the field, offering a very flexible and cost-effective solution for an “intelligent” I/O station.
- I/O modules can also be connected remotely via PROFIBUS. This allows for high flexibility in installation.
- SD card support

All three controller types can be used side by side within a project and can easily communicate with each other via the Ethernet based control network. The engineering is performed with one engineering tool, Freelance. All function blocks and pre-engineered functions are available for all controllers in the same way.

## 3.2 Functions

The scope of functions provided by the Freelance system corresponds to the basic supply defined in IEC 61131-3, in addition to numerous other high performance, industry-proven functions and function blocks. Furthermore user-specific function blocks can be added for dedicated tasks. During configuration, the processing capacity and speed of the controllers can be easily adapted to the demands of the automation task. Program execution in the controller is based on real-time multitasking operating system, leading to flexible strategies for processing programs.

The operating system of the controllers has two different types of tasks, system tasks and user tasks. System tasks supervise the system for example at cold start or in case of an

error. User tasks execute the application programs.

Different modes are available for user task execution:

- Up to eight tasks with individual cycle times between 5 ms and 24 hours
  - Processing as fast as possible (PLC mode); one task only
- System tasks are automatically available. These tasks are executed once in case of the following events:
- RUN
  - STOP
  - COLD START
  - WARM START (voltage restored)
  - REDUNDANCY TOGGLE
  - ERROR

Functions and function blocks	
Analog value processing	<ul style="list-style-type: none"> <li>– Input and output conversion</li> <li>– Linearization</li> <li>– Delay and dead-time filter</li> <li>– Average / extreme value determination in time</li> <li>– Setpoint adjustment</li> <li>– Counter with analog input</li> <li>– Time scheduler</li> </ul>
Binary value processing	<ul style="list-style-type: none"> <li>– Binary output, monostable</li> <li>– Input and output delay</li> <li>– Pulse / Time Counter, pushbutton</li> </ul>
Closed-loop control	<ul style="list-style-type: none"> <li>– Continuous controllers (PID), Step controllers</li> <li>– On / Off controller, three-position controller</li> <li>– Ratio controller</li> <li>– Basic functions</li> <li>– Auto-tuning</li> </ul>
Open-loop control	<ul style="list-style-type: none"> <li>– Individual drive functions</li> <li>– Sequence control, dosing circuits</li> </ul>
Logic functions	<ul style="list-style-type: none"> <li>– Logic processing</li> <li>– Average / Extreme value determination</li> <li>– Comparator, binary switch</li> <li>– Multiplexer</li> <li>– Converter (data type &amp; code)</li> <li>– Flip-flop, edge detection</li> <li>– String blocks</li> <li>– Radio controlled adjustment of daylight-saving time</li> </ul>
Monitoring	<ul style="list-style-type: none"> <li>– Analog and binary monitoring</li> <li>– Event monitoring</li> <li>– Audible alarm control</li> <li>– Connection monitoring</li> </ul>
Acquisition functions	<ul style="list-style-type: none"> <li>– Disturbance course acquisition, trend acquisition</li> </ul>
Arithmetic functions	<ul style="list-style-type: none"> <li>– Basic arithmetic functions, numerical functions</li> <li>– Logarithmic functions</li> <li>– Trigonometric functions</li> <li>– Analog value and time limitation</li> </ul>
Modbus functions	<ul style="list-style-type: none"> <li>– Master and slave functions</li> </ul>
PROFIBUS	<ul style="list-style-type: none"> <li>– DPV1 master functions</li> </ul>
Telecontrol functions	<ul style="list-style-type: none"> <li>– Master and slave functions</li> </ul>
Phase logic processing	<ul style="list-style-type: none"> <li>– Interface module for batch applications</li> </ul>



## 3.3 The controller AC 900F

### 3.3.1 Hardware and certificates

The AC 900F controller truly extends the hardware portfolio of Freelance distributed control system. Apart from its highly sophisticated automation functions, the AC 900F modular controller offers expanded flexibility via a pluggable SD card, more Ethernet ports, redundancy options for high availability and powers for around 1,500 I/Os when using the Standard CPU (PM 902F) or up to 400 I/Os when using the Lite CPU (PM 901F).

A key feature of the AC 900F is the support of SD cards. Especially the new optional display for AC 900F allows to load applications or firmware into the controller without the need of a terminal program on a computer.

Benefits at a glance:

- More power than any previous generation Freelance controller
- More connectivity with serial ports and Ethernet ports
- Built-in SD card support
- New Ethernet based protocols – Modbus TCP and IEC 60870-5-104
- G3 compliant as standard
- Built-in power supply
- Optional LCD providing enhanced security through controller lock
- Small footprint
- Optional redundancy

#### Mechanical design

Thanks to its four holes in the rear, the CPU modules PM 902F and PM 901F allow easy wall-mounting. DIN rail mounting is even faster and easier by just placing the component on top of the DIN rail and pushing it down to lock it in place.

#### Technical data

The AC 900F controller consists of a CPU module which is the main component. According to the application and requirements, further modules can be added to the controller. These modules are fieldbus interface modules and I/O modules.

The AC 900F consists of:

- CPU module PM 902F or PM 901F with
  - four Ethernet interfaces for PM 902F or three Ethernet interfaces for PM 901F
  - one diagnostic interface
  - two serial interfaces
  - display unit (optional)
- Up to ten S700 I/O modules directly attached on terminal units
- A maximum of two fieldbus interface modules

The AC 900F controller can be arranged in a single or redundant manner. The controller supports remote I/Os, transmitters, actuators, drives and other devices, for example through PROFIBUS and other fieldbus protocols. At present, the following field busses are available for the AC 900F controller:

- PROFIBUS DP V0/V1
- Modbus RTU and Modbus TCP
- Telecontrol and Telecontrol TCP
- CAN Bus for connection of Freelance Rack I/O

Input/output modules are used as direct I/O and remote I/O in accordance with the type and quantity of process signals.

The hardware configuration of AC 900F is based on a hardware function block concept similar to the configuration like AC 700F and AC 800F.

AC 900F can be equipped with a maximum of two PROFIBUS modules. You have the option to

run these controllers in redundancy.

Modular plug-in I/O modules are used in accordance with the type and quantity of process signals.

With AC 900F controllers, fieldbus compliant components such as remote I/O, field devices, and network components can be used. ABB offers equipment for applications covering standard and hazardous areas.

## Certificates

The AC 900F controller has the following certificates:

PM 902F: CE (2004/108/EC), cULus, ISA-S71.04 G3.

PM 901F: CE (2004/108/EC), UL/G3 approvals pending

## Environmental conditions

The ambient temperature range of AC 900F ranges from -20 to +70°C (operation), no forced cooling required.

Temperature ranges and other environmental conditions		
Ambient temperature AC 900F	Operating:	-20 ... +70°C (-4°F ... 158°F)*
	Storage:	- 40 °C ... +85°C (-40°F ... 185°F)
	Storage (TD 951F inserted):	- 25 °C ... +70 °C (13°F ... 158°F)
Ambient temperature of battery	Operating:	- 40 °C ... +85 °C (-40°F ... 185°F)
	Storage:	- 40 °C ... +85 °C (-40°F ... 185°F)
Humidity		Maximum 93%, without condensation
Air pressure	Operating:	< 2000 m (2187 yd.)
	Storage:	< 3500 m (3827 yd.)
Climatic category		3K3 according to EN 60721-3-3
Degree of protection		IP 20
G3 severity level		ISA-S71.04 G3

\* This temperature range applies to the new versions of PM 902F 3BDH001000R0005, HW Revision ≥ 06.00 and 3BDH001000R0001, HW Revision ≥ 03.00 and to the new PM 901F 3BDH001001R0005

## Electromagnetic compatibility

Temperature ranges and other environmental conditions	
2004/108/EC	Complies with the European directive
NAMUR NE21	Electromagnetic Compatibility of Industrial Process and Laboratory Control Equipment
IEC/EN 61000-4-3	Electromagnetic compatibility (EMC) – Testing and measurement techniques, Radiated, radio-frequency, electromagnetic field immunity test
IEC/EN 61000-6-4	Electromagnetic compatibility (EMC) – Generic standards, Emission standard for industrial environments

## Mechanical stress / mounting

### Mechanical stress and mounting

Mounting	Horizontal
Mounting of the modules	Wall mounting or DIN rail according to DIN EN 50022, 35 mm, depth 7,5 mm or 15 mm, mounting with screws of type M4, fastening torque 1.2 Nm
Flammability	According to UL 94 V0
Vibration resistance according to IEC/EN 60068-2-6	2 g, 2 Hz ... 150 Hz
Shock test according to IEC/EN 60068-2-27	15 g, 11 ms, half-sinusoidal

3

## Electric data / Electrical protection

### Voltages according to EN 61131-2

Process- and Supply-voltage	24 VDC
Absolute limits	+19.2 V ... +32.5 V incl. ripple (see below)
Ripple	< 5 %
Protection against reverse polarity	Yes

### Permissible interruptions of power supply as per EN 61131-2

DC supply	Interruptions < 7.5 ms, time between 2 interruptions > 1 s, PS2
-----------	--

### Creepage distances and clearances

The creepage distances and clearances meet the overvoltage category II, pollution degree 2.

### Power supply units

Power supply units meeting the PELV specification should be used for powering the modules.

## Power dissipation for the calculation of cooling systems

The following table lists the anticipated power dissipation (heat dissipation) of individual AC 900F modules.

The data for the modules contain the combined power consumption from internal and external supply sources. For detailed information see the Mounting and Installation Instructions, AC 900F manual.

Module	Max. power dissipation
Central processing unit PM 902F and PM 901F	18 W
Communication interface CI 930F	1.8 W
Communication module CI 773F	1.8 W
Communication module CM 772F	1.2 W
Communication interface CI 910F	1.9 W
Display unit TD 951F	0.35 W
Power supply CP-C 24/5.0 and CP-C 24/10.0	< 15 W / < 29 W



## 3.3.2 AC 900F redundancy concept

### Controller redundancy

Controller redundancy can be achieved by installing two AC 900F. To ensure quick and smooth takeover by the secondary AC 900F in case the primary AC 900F fails, a dedicated redundancy communications link through the second Ethernet module makes sure that both AC 900F are always synchronized. All inputs and outputs are designed to support redundant operation.

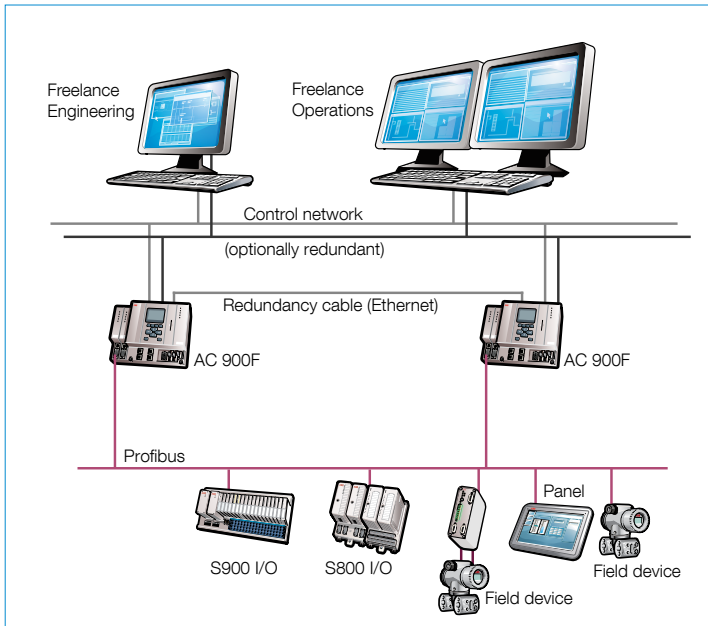

### Profibus line redundancy

The CI 930F communication interface provides integrated Profibus line redundancy. An alternative solution to the Profibus line redundancy is to use a Fiber Optic Ring.

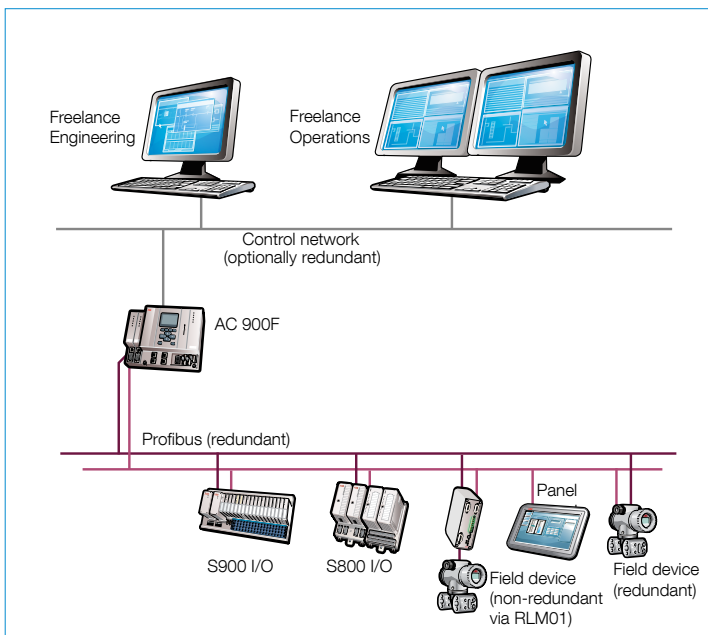

### Controller redundancy together with Profibus line redundancy

You can achieve the highest availability when doing both, controller redundancy and Profibus line redundancy by using two AC 900F with a CI 930F communication interface each. This topology combines the advantages of controller redundancy with the one of line redundancy as described in the preceding paragraphs.

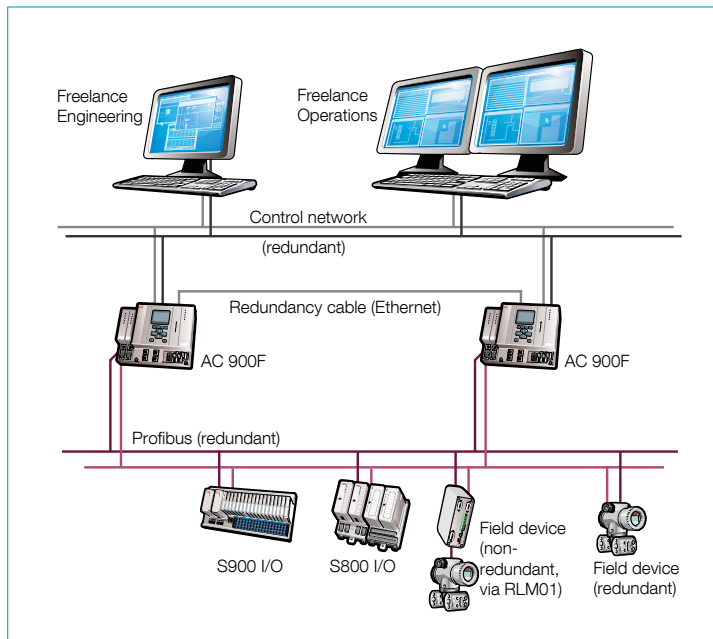

### 3.3.3 Central processing unit PM 902F, standard

Name	Short description	Article no.
PM 902F	<p>Central Processing Unit Without operating system. The operating system has to be loaded during software installation. Needs external 24 VDC power supply. Requires software version 2013 or higher. A two-slot terminal base for CI/CM modules is integral part of this CPU module. Without battery.</p>	3BDH001000R0005

The PM 902F CPU module is the central part of the AC 900F controller. It provides a high performance processor for multitasking and executing fast loop cycle times. It comes with four on-board 100 Mbit/s Ethernet network connections and two serial interfaces. A third serial interface is reserved for diagnosis purpose and radio clock connection. Coupler bus slots and an I/O bus interface enables for adding further modules left and right to the CPU modules.

A lite version PM 901F is also available, see section “3.3.4 Central processing unit PM 901F, lite” on page 18.

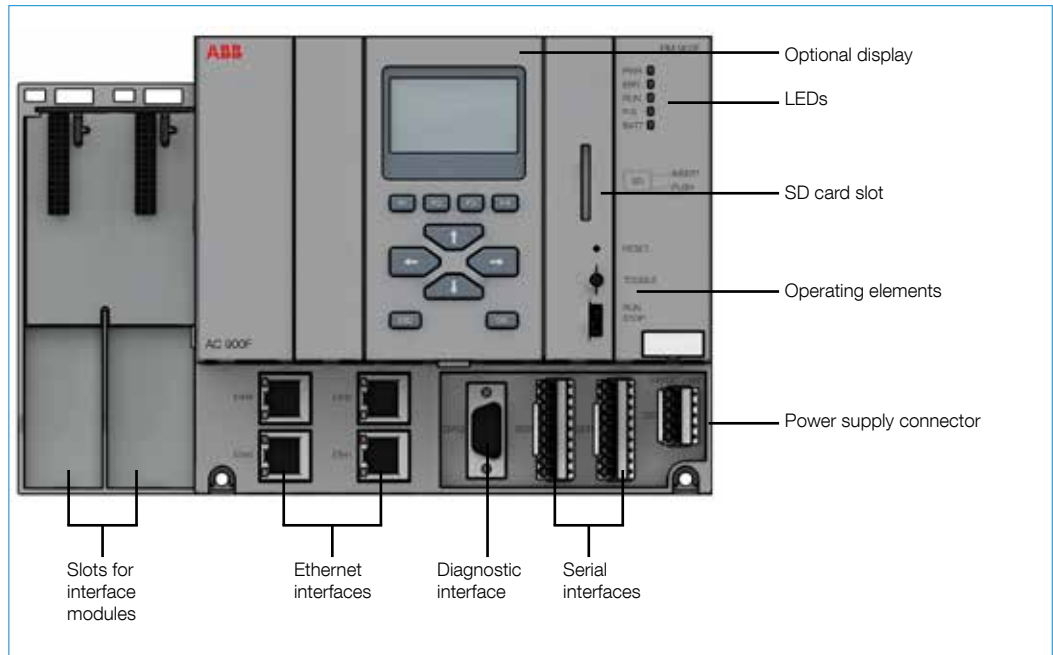

Figure 2: CPU module PM 902F

## Technical data

Technical Data PM 902F	
RAM battery buffered	8 MB
RAM	16 MB
CPU clock rate	800 MHz
Number of direct I/O modules	Up to 10
Power consumption	24 W (full station assembly)
Power supply	Terminal for 24 VDC power supply DC-IN +24 VDC
Max. power dissipation within the module	18 W
Current consumption from 24 VDC	1 A
Inrush current at 24 VDC	1.5 A
Data backup source	Lithium battery for SRAM contents and real time clock
Buffering time at +40 °C	> 2 years After battery low warning: 14 days
Battery low indication	Warning indication issued about 2 weeks before the battery charge becomes critical
Real-time clock, with battery backup	Yes
Multitasking program execution:	
Cyclic (equidistant)	Configurable cycle times from 5 ms
Cyclic (as fast as possible)	PLC mode
Event driven	Predefined events
Serial interfaces (SER1 and SER2)	
Physical link:	Configurable for RS-232 or RS-485 (from 600 bps to 38400 bps),
Connection:	Pluggable terminal block with spring connection
Usage:	Modbus RTU Telecontrol IEC 60870-5-101

### Technical Data PM 902F

Onboard network interface 4 Ethernet interfaces (RJ45)	
Ethernet 1:	for ControlNet (optional Modbus TCP and Telecontrol IEC 60870-5-104)
Ethernet 2:	for redundancy link
Ethernet 3 & 4:	for Modbus TCP and Telecontrol IEC 60870-5-104 or for ControlNet redundancy
Weight	1.07 kg (2.36 lbs)
Dimensions	Width 227 mm (8.94 inch) Height 152 mm (5.98 inch) Depth 95 mm (3.74 inch)

## 3.3.4 Central processing unit PM 901F, lite

Name	Short description	Article no.
PM 901F	<p>Central Processing Unit Without operating system. The operating system has to be loaded during software installation. Needs external 24 VDC power supply. Requires software version 2016 or higher. A two-slot terminal base for CI/CM modules is integral part of this CPU module. Without battery.</p>	3BDH001001R0005

A CPU module is the central part of the AC 900F controller. It provides a high performance processor for multitasking and executing fast loop cycle times. It comes with three on-board 100 Mbit/s Ethernet network connections and two serial interfaces. A third serial interface is reserved for diagnosis purpose and radio clock connection. Coupler bus slots and an I/O bus interface enables for adding further modules left and right to the CPU modules.

An optional front panel display shows status and diagnostic information directly at the module. Operating modes can be modified by switches on the front panel.

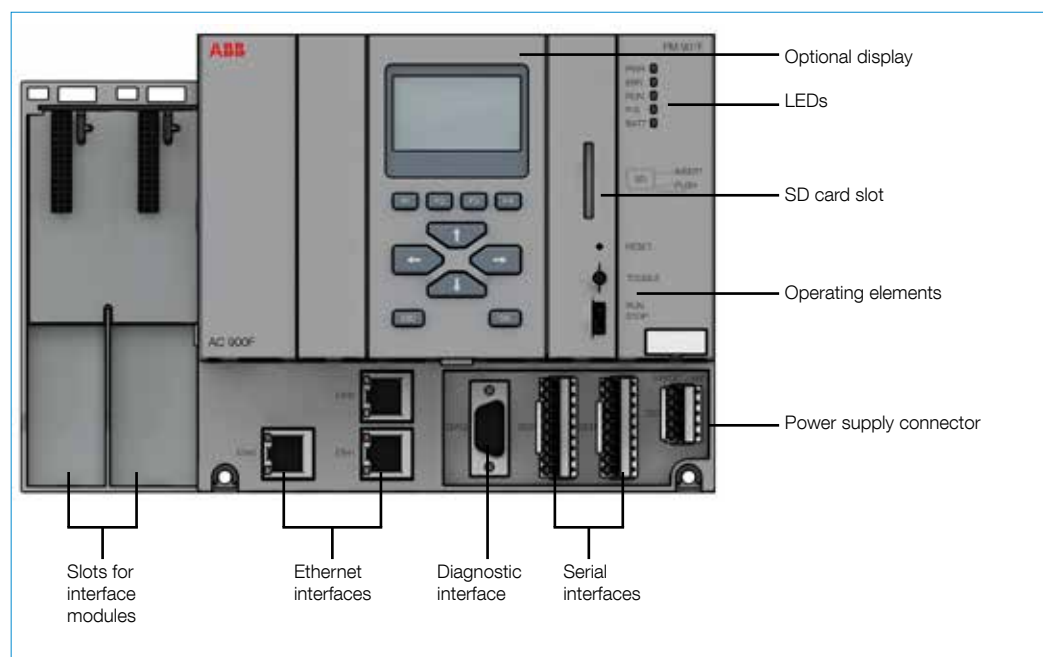

Figure 3: CPU module PM 901F

## Technical data

Technical Data PM 901F	
RAM battery buffered	3 MB
RAM	16 MB
CPU clock rate	400 MHz
Number of direct I/O modules	Up to 10
Power consumption	24 W (full station assembly)
Power supply	Terminal for 24 VDC power supply DC-IN +24 VDC
Max. power dissipation within the module	18 W
Current consumption from 24 VDC	1 A
Inrush current at 24 VDC	1.5 A
Data backup source	Lithium battery for SRAM contents and real time clock
Buffering time at +40 °C	> 2 years After battery low warning: 14 days
Battery low indication	Warning indication issued about 2 weeks before the battery charge becomes critical
Real-time clock, with battery backup	Yes
Multitasking program execution:	
Cyclic (equidistant)	Configurable cycle times from 5 ms
Cyclic (as fast as possible)	PLC mode
Event driven	Predefined events
Serial interfaces (SER1 and SER2)	
Physical link:	Configurable for RS-232 or RS-485 (from 600 bps to 38400 bps),
Connection:	Pluggable terminal block with spring connection
Usage:	Modbus RTU Telecontrol IEC 60870-5-101
Onboard network interface	
3 Ethernet interfaces (RJ45)	
Ethernet 1:	for ControlNet (optional Modbus TCP and Telecontrol IEC 60870-5-104)
Ethernet 2:	for redundancy link
Ethernet 3:	for Modbus TCP and Telecontrol IEC 60870-5-104 or for ControlNet redundancy
Weight	1.07 kg (2.36 lbs)
Dimensions	Width 227 mm (8.94 inch) Height 152 mm (5.98 inch) Depth 95 mm (3.74 inch)

### 3.3.5 PROFIBUS Communication Interfaces

Two types of PROFIBUS Master interface modules can be used with AC 900F: CI 930F and CI 773F. For AC 900F, these PROFIBUS interface modules enable communication over the PROFIBUS DP fieldbus. The interfaces can be mounted to the slots on the left side of the CPU module PM 902F (see “Figure 2: CPU module PM 902F” on page 17 and “Figure 3: CPU module PM 901F” on page 18). The internal coupler bus makes the connection to the CPU. PROFIBUS modules are configured in the Freelance Engineering hardware structure. Information on configuring the PROFIBUS module in hardware structure, see Engineering Manual System Configuration, Hardware Structure.

The parameter data directly influence the functionality of the module. Further information on configuration and parameterization of the module, refer to the Engineering Manual AC 900F.

3



#### Communication Interface CI 930F

Name	Short description	Article no.
CI 930F	Communication Interface, PROFIBUS DP Master DP-V0/V1, 12 MBit/s Supports PROFIBUS line redundancy Two D-Sub terminals (9-pole), one each for line A/B Software version 2013 or higher is mandatory Requires one coupler bus slot on the CPU module.	3BDH001010R0005

CI 930F is module is a PROFIBUS DP master, but with additional features compared to CI 773F. CI 930F supports built-in line redundancy. Each PROFIBUS module allows the connection of a PROFIBUS line of maximum of 126 slaves. Each of these slaves can be modular.

Technical data CI 930F	
Transmission protocol	PROFIBUS DP master, DP-V0/V1
Transmission rate	9.6 kBit/s to 12 MBit/s
Transmission standard	EIA RS-485 acc. to EN 50170, potential free
Fieldbus connectors	2 x D-SUB, 9-pole, female
Number of slaves	up to 126
Useable CPU	PM 902F or PM 901F
Data interchange	64 kB module, dual-port memory
PROFIBUS line redundancy	yes
Support controller redundancy	yes, with AC 900F
Hotplug, hot configuration in run	yes, with AC 900F
Current consumption	80 mA, via 24 V terminal of CPU module
Power dissipation	1.8 W
Status display	PWR, STA, RUN, Line A, Line B
Protection	IP20
Weight	115 g (0.25 lbs)
Dimensions	Width: 28 mm (1.1 inch) Height: 152 mm (5.98 inch) Depth: 85 mm (3.35 inch)
Ambient temperature	Operation: -20 .. +70 °C (-4 °F .. 158 °F) Storage: -40 °C .. +85°C (-40 °F .. 185 °F)
Certificates / Approvals	CE, ANSI/ISA 71.04-1985 G3 cULus, UL Class 1 Div 2 (Group A,B,C,D), EAC

### LED Status Displays

The PROFIBUS module CI 930F runs a self test during the power ON process. During the initialization procedure if the module is newly configured or if the operating mode is changed then all the LEDs may light up for a short period of time before reaching a definite condition.



## Communication Interface CI 773F

Name	Short description	Article no.
CI 773F	Communication Interface, PROFIBUS DP Master DP-V0/V1, 12 MBit/s D-Sub terminal, 9-pole Software version 2013 SP1 or higher is mandatory Requires the Fieldbus slot on PM 902F, PM 901F or Terminal Base TB 711F.	3BDH000395R0005

CI 773F is the successor of CM 772F. It offers additional features and enough memory (I/O bytes) for maximum number of Profibus Slaves. CI 773F supports controller redundancy.

### Technical data CI 773F

Transmission protocol	PROFIBUS DP master, DP-V0/V1	
Transmission rate	9.6 kBit/s to 12 MBit/s	
Transmission standard	EIA RS-485 acc. to EN 50170, potential free	
Fieldbus connectors	1 x D-SUB, 9-pole, female	
Number of slaves	up to 126	
Useable CPU	PM 902F, PM 901F or PM 783F	
Data interchange	16/64 kB, dual-port memory	
Current consumption	80 mA, via 24 V terminal of CPU module	
Power dissipation	1.6 W	
Status display	PWR, STA, RUN, L	
Protection	IP20	
Weight	96 g (0.21 lbs)	
Dimensions	Width:	28 mm (1.1 inch)
	Height:	135 mm (5.31 inch)
	Depth:	75 mm (2.95 inch)
Ambient temperature	Operation	-20 .. +70 °C (-4 °F .. 158 °F)
	Storage	-40 °C .. +70°C (-40 °F .. 158 °F)
Certificates / Approvals	CE, ANSI/ISA 71.04-1985 G3	
	cULus, UL Class 1 Div 2 (Group A,B,C,D), EAC	

### LED Status Displays

After having switched on, the CI 773F module performs a self-test during power-up. During the initialization procedure, with newly configured modules or after a change of the operating mode, then all the LEDs may light up briefly before reaching the defined status.

## 3.3.6 CAN Communication Interface

An AC 900F controller with CI 910F CAN Bus module allows for connecting Freelance Rack I/O. The CI 910F CAN Bus interface comprises three CAN Bus lines, CAN 1 to CAN 3. The lines are electrically isolated from the system and designed for redundant operation with a second AC 900F controller.

The internal coupler bus connects the CI 910F to the CPU module. This is valid for both data transmission and power supply. A dual port RAM is used for data exchange.

CAN modules are configured in the Freelance Engineering hardware structure. Information on configuring the CAN module in hardware structure, see Engineering Manual System Configuration, Hardware Structure. The parameter data directly influence the functionality of the module. Further information on configuration and parameterization of the module, refer to the Engineering Manual AC 900F.



### Communication Interface CI 910F

Name	Short description	Article no.
CI 910F	Three CAN Bus channels. ABB CAN Bus protocol. D-Sub terminals (9-pole). Software version 2015 or higher is mandatory.	3BDH001005R0005

#### Technical data CI 910F

Transmission protocol	ABB CAN Bus protocol
Transmission rate	max. 1 MBit/s
Settings for rack-based I/O modules	100 kBit/s or 500 kBit/s depending on bus length
Fieldbus connector	D-SUB, 9-pole, female
CAN interface	Acc. to ISO/DIN 11898, CAN 2.0
Electrical isolation	CAN channels to system
Number of I/O racks	max. 5
Dual-port memory	256 kB
Channels / Lines	CAN 1, CAN 2, CAN 3
Power supply	Via coupler bus
Current consumption	90 mA, via DC-IN of the CPU module
Power dissipation	1.9 W
Number of CI 910F modules per controller	max. 1, optionally in slot C1 or C2
Useable CPU	PM 902F or PM 902F
LEDs	Five LEDs for the status display
Support controller redundancy	yes, with AC 900F
Hotplug, hot configuration in run	yes, with AC 900F
Status display	PWR, STA, L0, L1, L2
Protection	IP20
Weight	178 g (0.39 lbs)
Dimensions	Width: 28 mm (1.1 inch) Height: 152 mm (5.98 inch) Depth: 75 mm (2.95 inch)
Ambient temperature	Operation: -20 .. +70 °C (-4 °F .. 158 °F) Storage: -40 °C .. +85°C (-40 °F .. 185 °F)
Certificates / Approvals	CE Pending: ANSI/ISA 71.04-1985 G3, cULus, UL Class 1 Div 2 (Group A,B,C,D), EAC



### LED Status Displays

After having been switched on, the CI 910F CAN Bus module performs a self-test during power-up. During initialization, with newly configured modules or after a change of the operating mode, all LEDs may light up briefly before reaching the defined status.

### CAN Bus connector

The CAN Bus connector of CI 910F features the following pin assignment:

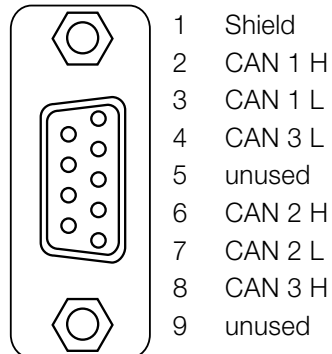

CAN Bus  
9-pole, Female

### Connection of Freelance Rack I/O

When connecting the AC 900F controller to a Freelance rack, you will have to remove the DCP 02/10 CPU modules.

### AC 900F controller at the beginning (end) of the CAN Bus

The TP 910F CAN Bus termination plug is used for terminating the three CAN buses directly at the controller at the beginning (end) of the bus lines. The open end of the TK 811F CAN cable is connected to the screw terminals of the TP 910F plug.

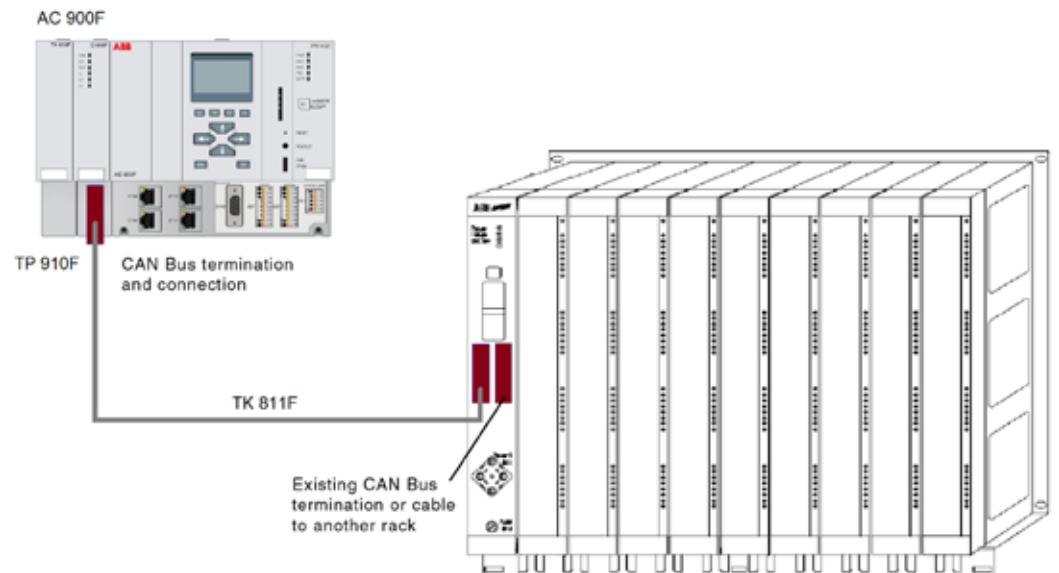

### Redundant AC 900F controller at the beginning (end) of the CAN Bus

The terminating resistors integrated into the TP 910F termination plug ensure that the termination and, thus, the function of the three CAN Bus lines is preserved even if a CAN bus module or controller is replaced. TB 870F is used for connecting the CAN bus between controllers and to the I/O rack.

The TK 831F cable contains feed and return lines. When replacing a CI 910F module or controller, only disconnect the 9-pole connector. Disconnecting the 25-pole connector will interrupt the CAN Bus.

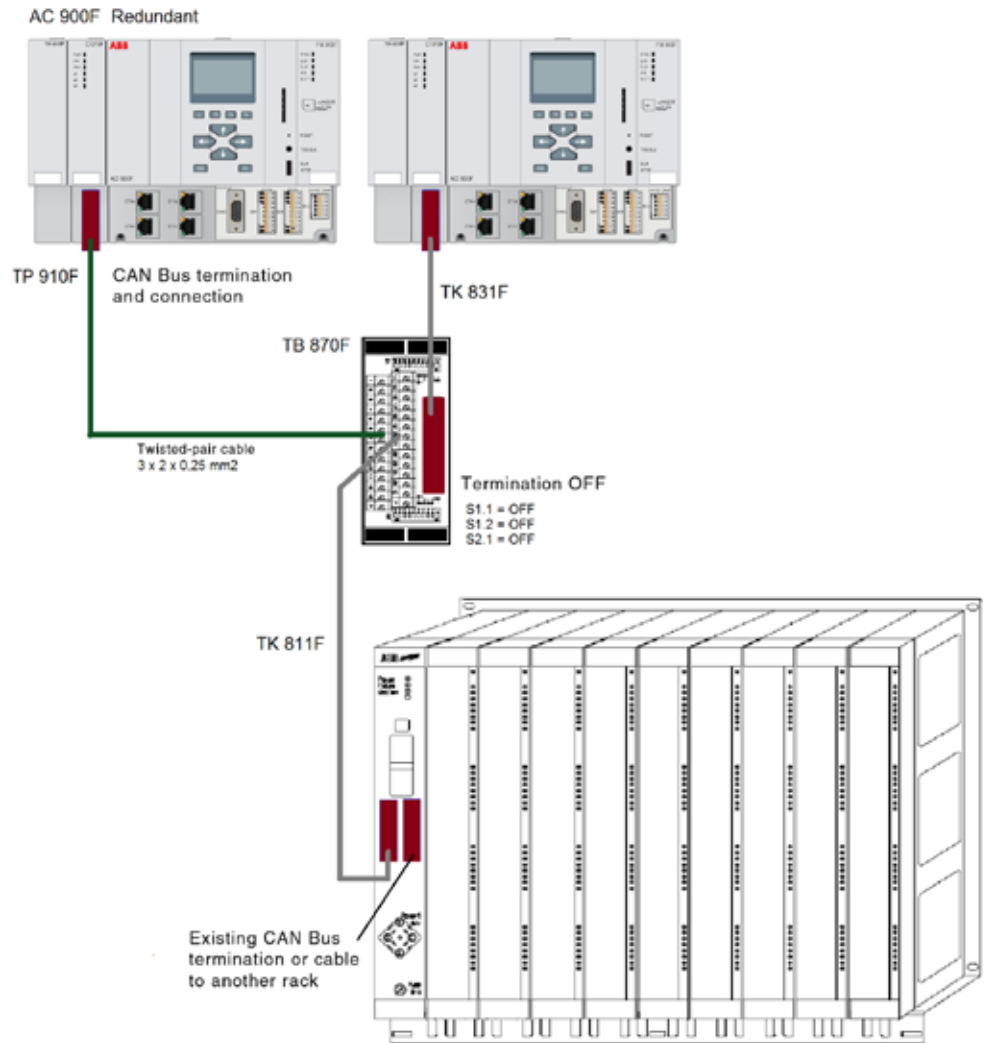

## 3.3.7 Accessories

### TD 951F Display Unit



This is an optional accessory. It provides a dot matrix LCD with 128 x 64 pixel resolution, keypad with six predefined and four function keys. The display unit allows the following functions:

- Network settings
- Backup/Restore application
- Status display
- Display of process variables
- Module exchange
- Firmware update
- Lock/unlock the controller against firmware and application downloads

### TA 951F Battery for RAM buffering

TA 951F contains a 2/3A size Lithium battery with cable connection. The battery is sealed within a plastic pack. It is possible to exchange this battery without stopping the CPU module. In the event of power failure, the TA 951F Lithium battery supplies power to store the SRAM contents (e.g. process and configuration data) and to back-up the real time clock. The CPU module is supplied without a Lithium battery. New battery TA 951F is inserted before starting the CPU module.

Although the CPU module can work without a battery, its use is still recommended in order to avoid losing process data. The CPU module monitors the discharge status of the battery. A pre-warning indication is displayed before (at least two weeks in advance) the battery status becomes critical. The battery should be replaced in fixed intervals or as soon as possible after this error indication is displayed. The TA 951F Lithium battery is the only battery that can be used with CPU module PM 902F. It is a primary cell and cannot be recharged.

#### Technical data:

- Lithium cylindrical cell
- 3 V, 1200 mAh
- Primary cell, non rechargeable
- Protection against reverse polarity is by mechanical coding of the plug



TA 924F

## Dummy coupler Modules

Name	Short description	Article no.
TA 924F	Dummy Coupler Module Empty module, to protect an unused coupler slot from dust and touch.	3BDH001031R0005
TA 724F	Dummy Coupler Module Empty module, to protect an unused coupler slot from dust and touch.	3BDH000367R0001

## White Plastic Markers

Name	Short description	Article no.
TA525	White Plastic Markers, 10 pcs. For labelling CPU and I/O modules of AC 700F/AC 900F/S700	3BDH000395R0005

## Accessories for AC 900F CAN Bus installation

Name	Short description	Article no.
TP 910F	CAN Bus Termination Plug Integrated termination resistors. Screw type clamps. Connection of the Freelance rack based I/O.	3BDH001033R0001
TB 870F	Terminal Block, for serial interface	3BDM000160R1
TK 811F	CAN Cable, open end, ferrules, 3 m 3 x 2 x 0.25 mm <sup>2</sup> , The cable is used for connection of Freelance Rack I/O to the CI 910F CAN Bus Module.	3BDM000103R1
TK 831F	CAN Cable (3 channel), integral connectors, 0.5 m 3 x 2 x 0.25 mm <sup>2</sup> The cable connects the CI 910F CAN Bus Module to the TB 870F Terminal Block	3BDM000100R1



## 3.4 The controller AC 800F



3

The AC 800F controller has a modular structure. The CPU is designed as a backplane to which various modules – power supply units, Ethernet and fieldbus modules – can be attached in line with the application. On the fieldbus side, modules for PROFIBUS-DPV1, FOUNDATION Fieldbus HSE, Modbus, Telecontrol IEC 60870-5-101, Telecontrol IEC 60870-5-104 and CAN for Freelance Rack I/O are available.

The fieldbus line and the connected field devices are entirely configured and parameterized using the engineering tool Freelance. No further external tools are needed for configuration. Fieldbus and device configuration can be performed offline without connection to the field devices. In case of Profibus, field devices or slaves can be integrated into the system using device specific GSD<sup>1</sup> files or DTMs<sup>2</sup>. If for a certain device no DTM is available, generic GSD files of Profibus slaves can be used instead. Together with S900 remote I/O, HART variables are cyclically available as process data.

In the case of FOUNDATION Fieldbus, configuration takes place using specific CFF<sup>3</sup> or DD<sup>4</sup> files. Field devices are connected to H1 links, which in turn are connected via LD 800HSE linking devices to the high-speed HSE subnet.

Even a single AC 800F controller can be connected to both buses, Profibus and FOUNDATION Fieldbus at the same time. This makes it very convenient to run loops of an FF application using “control in the field” technology, while at the same time gathering fast binary data via high-speed Profibus using remote I/Os.

### Features:

- Controller with built-in fieldbus capability
- 4 high-speed fieldbus lines
- Supports different fieldbus types, even simultaneously:
  - PROFIBUS-DP, up to 12 MBd
  - FOUNDATION Fieldbus H1 (with LD 800HSE)
  - HART
  - Modbus RTU and Modbus TCP
  - Telecontrol IEC 60870-5-101 and Telecontrol IEC 60870-5-104
  - CAN (for Freelance Rack I/O)
- Easy engineering: fully integrated in Freelance
- One system-wide database for field devices shared by the control level and the Human System Interface
- Module recognition with factory and operational parameters
- Comprehensive diagnostics for predictive maintenance
- Compact, rugged design
- Front panel connectors
- DIN Rail (C-rail) or wall mounting for easy installation
- Ambient temperature 0-60 °C / 32-140 °F with temperature monitoring
- EMC certification according to EN50082

<sup>1</sup> GSD = Device Master Data, abbreviation for the German term „Gerätstammdaten“. A GSD is the device database file (also called device data sheet)

<sup>2</sup> DTM = Device Driver based on FDT technology

<sup>3</sup> CFF= Capabilities File

<sup>4</sup> DD= Device Description

## 3.4.1 Hardware and certificates

### Mechanical design

The front panel connection technique of the AC 800F controller makes it exceptionally easy to assemble and to service. Mounting on the wall can be achieved very easily. All AC 800F modules are inserted into slots from the front and secured in position with screws. The modules are activated using a lock switch, which conceals the upper screw opening. The lock switch must be opened to reach the upper screw opening.

By moving the screw-cover, the wish to remove the module from the CPU is signalized, and the fieldbus is automatically shut down. As a result, the remote I/Os and field device outputs have time enough to go to configured safety values, avoiding undefined states when the module is removed.

All modules are surrounded by metal housing when installed, which gives them optimum mechanical and electrical protection. All housing materials used are simply screwed together, allowing them to be separated for future recycling. Last but not least, Freelance has taken environmental protection into account by using a minimal amount of paint.

### Technical data

AC 800F opens up the flexibility of fieldbus technology to the user. It collects and processes diagnostic and process data from four fieldbus lines, which may be of different types. AC 800F is available with 16 MB for typically up to 1000 I/Os.

Up to four fieldbus modules can be plugged into the AC 800F controller. The communication with other controllers runs via Ethernet.

AC 800F optionally provides several levels of redundancy:

- Controller redundancy with two identically equipped AC 800F controllers, which means full redundancy versus just a CPU-board redundancy. Possibility to mount the redundant unit far away from each other, e.g. in a fire proof room
- Line redundancy for Profibus DP, by using external equipment (Redundancy Link Module RLM01)

The availability of the control network can be increased by using ring topologies. The data protection is made via battery backup.

### Certificates

The AC 800F controller has the following certificates:

- CE, NAMUR, UL, EN61000-6-2, G3 ISA71.04, ISO 9001

## System Communication

Bus type	Max. length	Application	Standard	Transmission rate
Twisted Pair (TP)	5 x 100 m 5 x 400 m for shielded TP	Control network connection of Freelance operator stations	DIN/ISO 8802 Part 3 (IEEE 802.3) 10BASE-FL	10 MBit/s
Fiber optic (FL)	4500 m	(for operation and observation), engineering station and controllers	DIN/ISO 8802 Part 3 10BASE-FL (IEEE 802.3)	10 MBit/s
Thin-Ethernet (Cheapernet)	5 x 185 m		DIN/ISO 8802 Part 3 (IEEE 802.3) 10BASE2	10 MBit/s
Control network Full-Ethernet (Yellow Cable)	5 x 500 m for Coax, 50 m for AUI		DIN/ISO 8802 Part 3 (IEEE 802.3) 10BASE5	10 MBit/s
Station bus (CAN-Bus)	80 m, 400 m	Station bus and as connection to I/O units	ISO/DIN 11898	500 KBit/s for 80 m 100 KBit/s for 400 m

## Fieldbus modules

The AC 800F uses the fieldbus modules to collect and process real-time and diagnostic data. Up to four fieldbus modules can be mounted into one AC 800F.

The fieldbus modules have the following tasks and characteristics:

- Electrical isolation between the process and the Controller
- Status LEDs for each module
- Independent fault detection and fault signaling
- Connection of the fieldbus segments and subnets

Details of the fieldbus modules			
Type	Channels	Function	Max. number of modules per controller
CAN module	3	Connection of up to 5 Freelance I/O racks	1
Serial module	2	RS232 / RS422 / RS485 configurable for MODBUS, IEC 60870-5-101 Telecontrol protocol	4
PROFIBUS module	1	Full-value PROFIBUS DPV1 Master	4
FF-HSE module	1	For the connection of up to 10 LD 800HSE Linking Devices with 10/100 Mbaud autosense twisted pair connection	4



## Ethernet modules

Controllers, operator stations, and engineering stations communicate with each other via the Ethernet based control network.

Ethernet modules for the control network		
Type	Channels	Function
Ethernet module EI 813F	1	Twisted pair connection 10 base T for connection to hubs or switches

3

## Linking devices

As the AC 800F is equipped with high-speed connections to both PROFIBUS (PROFIBUS DP) and FOUNDATION Fieldbus (FF-HSE), the slower buses of the two fieldbus technologies (PROFIBUS PA and FF-H1) can be connected using intelligent linking devices. These devices allow to connect several slow buses to one fast bus, with the advantage that a lot more field devices can be connected to an AC 800F station than when the slow fieldbuses are connected directly.

### PROFIBUS DP / PA linking device

The PROFIBUS Power Hub is an interface between the PROFIBUS DP and the PROFIBUS PA. Combining a PROFIBUS Power Hub with a field barriers and segment protectors makes it possible to connect field devices to a control system, which are located in intrinsic safe areas. The field barriers and segment protectors can be connected to the non-intrinsically safe outputs (trunks) of PROFIBUS Power Hub. PROFIBUS Power Hub is a device from Pepperl+Fuchs.

### FOUNDATION Fieldbus linking device LD 800HSE

FOUNDATION Fieldbus (FF) is a fieldbus protocol based on international standards and designed for applications in the manufacturing industry, process automation and buildings automation. FF defines two communication profiles, H1 and HSE. The H1 profile, with a transmission rate of 31.25 kbit/s, is preferably used for direct communication between field devices in one link (H1 link).

The HSE profile, which is based on standard Ethernet and typically features a transmission rate of 100 Mbit/s, serves a backbone for the connection between H1 links. The LD 800HSE connects the HSE Ethernet with the field devices on the H1 link side. They serve as a gateway between the field devices on the H1 link and the HSE subnet. LD 800HSE is also designed for redundancy.

## Fieldbus infrastructure

To protect fieldbus segments and links, appropriate fieldbus barriers can be used. For H1 links, power conditioners have to provide sufficient current. Furthermore proper network switches should be used to connect AC 800F FF modules and several LD 800HSE.

## 3.4.2 AC 800F redundancy concept

### Controller redundancy

Controller redundancy can be achieved by installing two AC 800F. To ensure quick and smooth takeover by the secondary AC 800F in case the primary AC 800F fails, a dedicated redundancy communications link through the second Ethernet module makes sure that both AC 800F are always synchronized. All inputs and outputs are designed to support redundant operation.

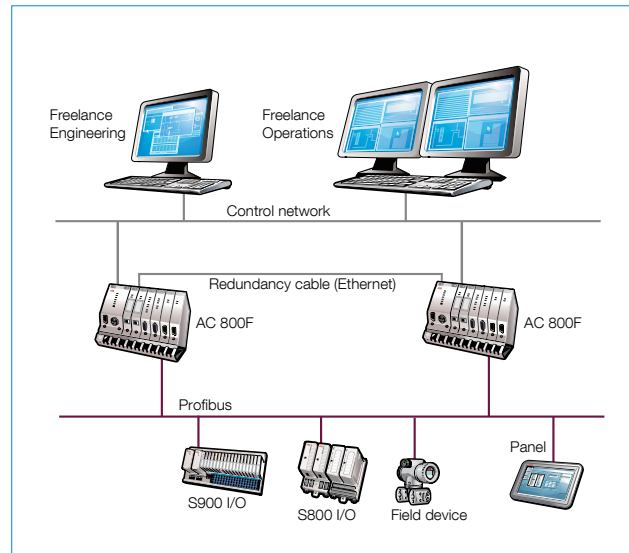

### Profibus line redundancy

Using the Redundancy Link Module RLM 01 will do the conversion of one simple, non-redundant Profibus line into two reciprocally redundant lines. You can position the Redundancy Link Module RLM 01 directly after a Profibus module (master), before a bus segment with several slaves or before an individual slave. PROFIBUS stations with redundant couplers can be directly connected to the PROFIBUS set redundant by RLM 01. Stations with only one interface can be optionally assigned to the one or other line. An alternative solution to the Profibus line redundancy is to use a Fiber Optic Ring.

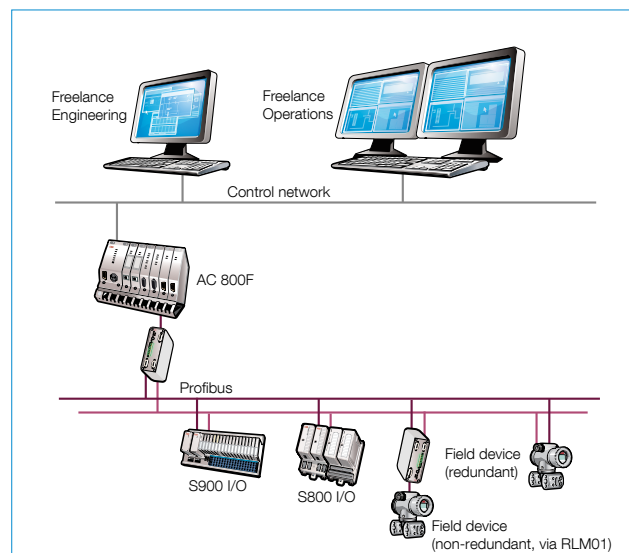

### Controller redundancy together with Profibus line redundancy

You can achieve the highest availability when doing both, controller redundancy and Profibus line redundancy by using two AC 800F with one RLM01 each. This topology combines the advantages of controller redundancy with the one of line redundancy as described in the above paragraphs.

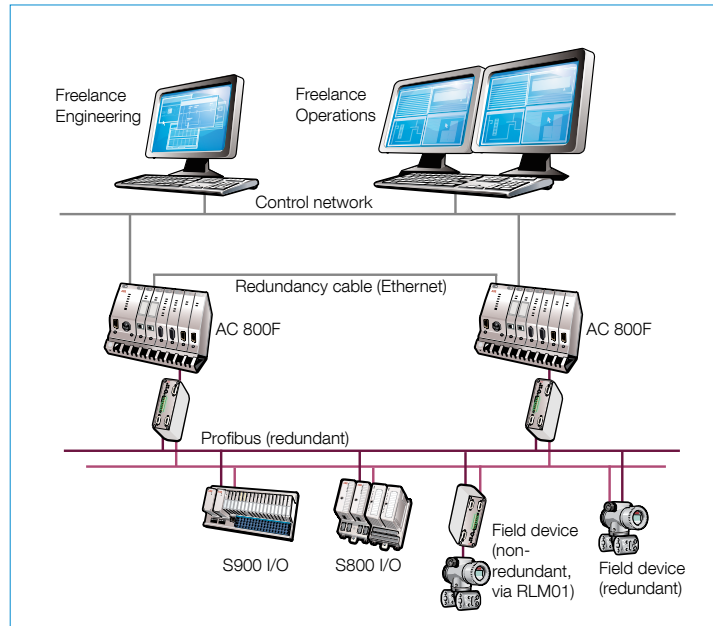

### Controller redundancy together with FOUNDATION Fieldbus redundancy

FOUNDATION Fieldbus redundancy can be achieved by installing two LD 800HSE. To ensure quick and smooth takeover by the secondary LD 800HSE in case the primary LD 800HSE fails, both devices are linked via a redundancy cable (COM).

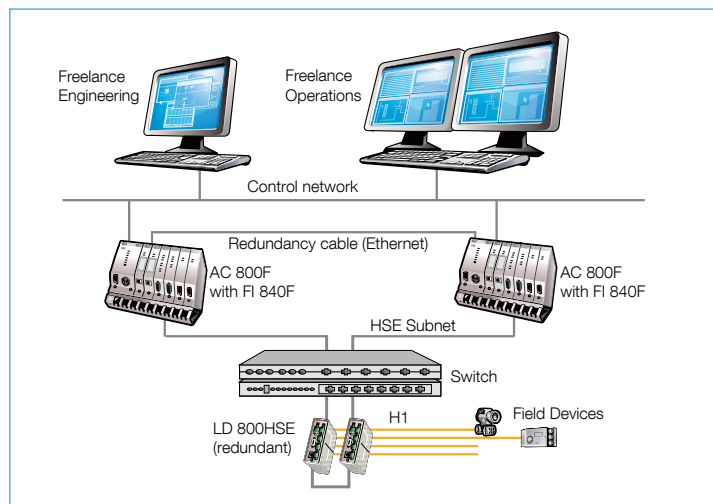

## Environmental conditions

Temperature ranges and other environmental conditions	
Max. ambient temperature	0 °C - 60 °C / 32 °F - 140 °F (no fan required)
Max. module internal temperature	0 °C - 70 °C / 32 °F - 158 °F (temperature monitoring on the CPU board)
Temperature gradient	In operation: 1 °C (33.8 °F) / min, according to DIN IEC 68, Part 14 / EN 60068-2-14(11.99)
Transport and storage temperature	-25 °C - +85 °C / -13 °F / 185 °F
Permissible relative humidity	Non-condensing, ≤ 80 % annual average ≤ 95 % for 30 days per year maximum
Degree of humidity	RH-1, according to EN 61131-2: 1994 (IEC 1131-2)
Climatic category	KWF according to DIN 40040 (replaced by EN 60721-3-3 and EN 61709) 3K3 according to DIN IEC 721 / EN 60721-3-3
Degree of protection	For basic unit with module complement: IP20
G3 severity level	ISA71.04 G3 compliant (-Z variant)

## Electromagnetic compatibility

Electromagnetic compatibility	
2004/108/EC	Complies with the European directive
EN 61000-6-2	Electromagnetic compatibility (EMC) – Generic standards, Immunity for industrial environments
EN 61000-6-4	Electromagnetic compatibility (EMC) – Generic standards, Emission standard for industrial environments
2006/95/EC	Low Voltage Directive
NAMUR NE21	Electromagnetic Compatibility of industrial process and laboratory control equipment

## Electrical protection

Electrical protection	
Safety class	II
Overvoltage category	II for all connectors, pollution degree 2
Designed according to	IEC 1010-1 (1990 - 09); EN 61010-1 / 3.94 or DIN/EN 61010-Part 1 / 3.94 (VDE 0411-Part 1), CSAC 22.2, No. 1010-1 and No. 213 (Class I, Div 2), SIQ (CB Scheme 97NK2421), CSA / NTRL.
Module supply power	Extra low voltage with protective separation from other circuits which may be grounded according to DIN VDE 0100, Part 410-1.97/IEC 60364-4-41/10.92
Power supply SA 811F	Safety isolating transformer according to DIN VDE 0551, Part 1 (9.95); EN 60742 Optocoupler for protective separation against electrical shock (German standard VDE 0884 / 8.87)
Power supply SD 812F	No electrical separation!

## Shock and vibration data

Shock and vibration data	
Tested according to DIN IEC 68, Part 2-6, 2-27 / EN 60068-2-6, 2-27 (11.99)	
Transport:	
Shock	30 g / 11 ms / 3 times to each axis Max. values for the individual modules. The values are valid for correct mounted modules.
In operation:	
Vibration, 3x5 cycles	2 g / 0.15 mm / 5 - 150 Hz

3

## Power dissipation for the calculation of cooling system

The following table lists the anticipated power dissipation (heat dissipation) of individual AC 800F modules.

The data for the modules contain the combined power consumption from internal and external supply sources. For detailed information see the "Mounting and Installation Instructions, AC 800F" manual.

Module	Max. power dissipation
Basic unit PM 803F	
- power supply SA 811F	26.8 W
- power supply SD 812F	13.8 W
Ethernet module EI 813F	1.2 W
CAN-module FI 810F	2.6 W
Serial module FI 820F	2.6 W
Profibus module FI 830F	2.8 W
FF / HSE module FI 840F	2.1 W
Battery module AM 811F	0.28 W

### 3.4.3 AC 800F, pre-assembled stations

Name	Short description	Article no.
AC 800F – 16 MB, 115 / 230 VAC	<p>– With Ethernet 10BaseT, PROFIBUS module and Base Unit PM 803F</p> <p>Incl. standard system test, battery SB 808F, mains cable TK 807F (open end).</p> <p>Slot assignment: P = SA 811F, E1 = EI 813F, F3 = FI 830F, E2, F1, F2, F4 = Front panel.</p> <p>Compliant to UL by using mains cable TK 809F (3BDM000212R1).</p> <p>Freelance V7.1SP2a or higher is mandatory.</p>	3BDH000103R1
AC 800F – 16 MB, prepared for redundancy, 24 VDC	<p>– With Ethernet 10BaseT, PROFIBUS module and Base Unit PM 803F</p> <p>Incl. standard system test, 2 batteries SB 808F, 2 mains cable TK 802F (open end).</p> <p>Slot assignment: P = SD 812F, E1, E2 = EI 813F, F3 = FI 830F, F1, F2, F4 = Front panel.</p> <p>Freelance V7.1SP2a or higher is mandatory.</p>	3BDH000133R1

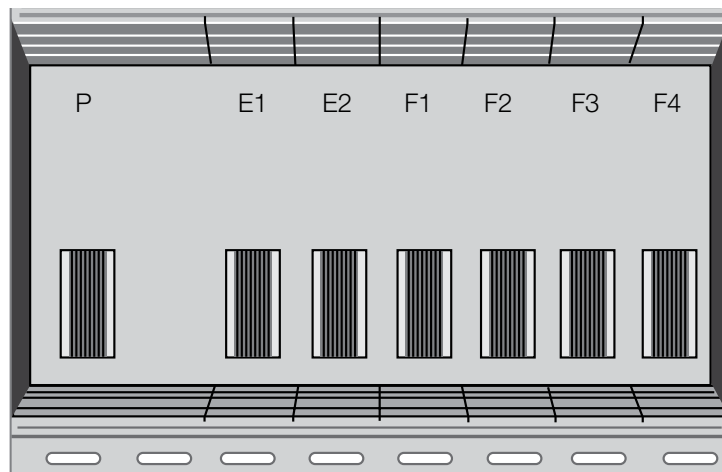
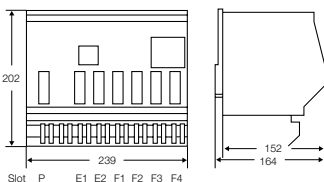

Figure 4: AC 800F Housing with slot assignment

### 3.4.4 AC 800F, base unit PM 803F



Name	Short description	Article no.
PM 803F	<p>Base Unit 16 MB, battery-buffered RAM</p> <p>Without operating system. The operating system has to be loaded during software installation. With special Contact Ledge RW 855F.</p> <p>Freelance V7.1PS2a or higher is mandatory.</p>	3BDH000530R1

The basic unit PM 803F, cyclically scans signals from the fieldbus lines via the corresponding fieldbus modules, processes these signals according the application programs installed by the user and sends appropriate signals to the fieldbus actuators via the fieldbus modules.

Controller redundancy can be achieved by using two AC 800F, see also “3.4.2 AC 800F redundancy concept” on page 32. To ensure quick and smooth takeover in milliseconds by the secondary AC 800F in case the primary AC 800F fails, a dedicated redundancy communications link through the second Ethernet module makes sure that both AC 800F are always synchronized. All inputs and outputs are designed to support redundant operation.

Data communication between AC 800F, the engineering and operator stations runs via the control network. Engineering station communications can involve new or updated configuration files being downloaded to the controller, or information about the connected modules being reported back. When fieldbus modules are installed or exchanged, the required configuration information is automatically updated.

Configuration and real-time process data is stored in the controllers. To safeguard this data in case of power loss, the RAM power is backed up with batteries located either on the Ethernet modules or on battery modules.

**Features:**

- Super Scalar RISC microprocessor (up to 150 MIPS)
- 16 K internal CPU cache RAM
- RAM memory with error detection and correction
  - 16 MB synchronous dynamic
- Flash-EEPROM
  - 8 MB, 32-bit words
- EEPROM, serial, 16 kbit
- Monitoring of the temperature inside the device
- Watchdog
- 4 slots for fieldbus modules
- 2 slots for Ethernet communications modules, 32-bit data bus, 10 Mbits/s
- Battery backup incl. battery watchdog
- G3 compliant Z variant available

**Technical data**

Technical data PM 803F	
CPU	CPU Intel® 32-bit RISC Super Scalar processor up to 150 MIPS
RAM	16 MB synchronous dynamic read / write memory, battery back up
I/O scan cycle time	Selectable by configuration. Depends on the capabilities of the fieldbus module
Processing time for 1000 instructions	0.78 ms for binary instructions 0.78 ms for word instructions 1.09 ms for floating point instructions
Power consumption	Basic unit only: max. 7.8 W depending on CPU usage and cycle time
Power supply	SA 811F: 115 - 230 VAC SD 812F: 24 VDC
Max. power output	See power supply modules
Weight	1.6 kg / 3.3 lbs max. 5 kg / 11 lbs (fully assembled)
Dimensions	Width: 239 mm (9.4 inch) Height: 202 mm (8 inch) Depth: 164 mm (6.5 inch)

## 3.4.5 Power supply

### SA 811F



3

Name	Short description	Article no.
SA 811F	Power Supply 115 / 230 VAC To use together with PM 803F. Freelance V7.1SP2a or higher is mandatory.	3BDH000013R1

The AC 800F modules are supplied with 5 VDC / 5.5 A and 3.3 VDC / 6.5 A by SA 811F. The power supply has open-circuit, overload and sustained short-circuit protection. The electronically controlled output voltage provides high stability and low residual ripple.

In case of power loss  $\geq 5$  ms, the power supply module generates a power-fail signal. This signal is used by the CPU module to shut down operations and enter to a safe state of connected outputs of Remote I/Os. This is required for a controlled restart of the system and the user application when power is restored. The output voltage remains within its tolerance limits for at least another 15 ms. Altogether a mains voltage drop of 20 ms will be managed.

#### Features:

- Input voltage 115 - 230 VAC (self adjusting), output is electrically isolated
- Power supply outputs provide: 5 VDC / 5.5 A and 3.3 VDC / 6.5 A
- Enhanced power-fail prediction and shutdown procedures
- LED indication for power supply status and operating status of the AC 800F
- Short circuit proof, current limited
- 20 ms backup energy for use in the event of primary power failure, according to NAMUR
- G3 compliant Z variant available.

### Technical data

Technical data SA 811F	
Input voltage	Alternating current 115 - 230 VAC Permissible range 90 - 260 VAC Frequency: 50 - 60 Hz (47 - 63 Hz)
Input current at nominal load	230 VAC: 275 mA 115 VAC: 541 mA
Rated input power	63 VA
Backup energy for the event of power failure	> 20 ms
Fuse	Subminiature fuse 2.5 AT, soldered
Output voltage	3.3 VDC ( $\pm 3\%$ ) typical 5 VDC ( $\pm 3\%$ ) typical
Output current	0.5 - 6.5 A to 3.3 V 0.5 - 5.5 A to 5.0 V
Current limit	Approx. 7.5 A Automatic return to normal operation after short circuit
Total output power	Max. 35 W
Weight	0.460 kg, 1.014 lbs



## LED displays

LED	Status	Description
Power		Internal supply voltage is available
Failure	Off	Normal status
	Orange	Self test
	Flashing orange	Overtemperature occurred during operation
	Red	Hardware failure of the basic unit
	Flashing red	Software failure of the system
Run/Stop	Green	Processing active
	Flashing green	Process was stopped and is now started again
	Red	Processing inactive
	Flashing red	Process was active and is stopped now
	Orange	Self test
	Off	Software initialization
Prim/Sec	In case of redundancy please see the LEDs description in the manual "Mounting and Installation Instruction AC 800F". For non-redundancy the states are:	
	Orange	Self test
	Off	Normal status

3

## Operator controls

Control	Description
Run/Stop switch	Internal supply voltage is available
Toggle Prim/Sec	For redundancy. Toggles between primary and secondary AC 800F (operational on primary AC 800F only, and only if a secondary AC 800F is available)
Reset	Reset button press and hold > 4 s for coldstart

## Front panel connections

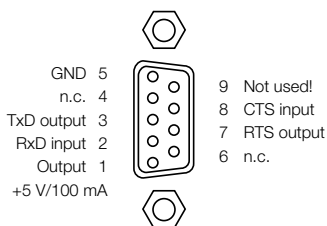

Control	Description
Power supply	One connector for 115 - 230 VAC input
Diag	For diagnostics and optional radio-controlled clock 9-pin male connector



## SD 812F

Name	Short description	Article no.
SD 812F	Power Supply 24 VDC To use together with PM 803F. Freelance V7.1SP2a or higher is mandatory.	3BDH000014R1

The AC 800F modules are supplied with 5 VDC / 5.5 A and 3.3 VDC / 6.5 A by SD 812F. The power supply has open-circuit, overload and sustained short-circuit protection. The electronically controlled output voltage provides high stability and low residual ripple.

In case of power loss  $\geq 5$  ms, the power supply module generates a power-fail signal. This signal is used by the CPU module to shut down operations and enter to a safe state. This is required for a controlled restart of the system and the user application when power is restored. The output voltage remains within its tolerance limits for at least another 15 ms. Altogether an input voltage drop of 20 ms will be managed..

### Features:

- Redundant input voltage 24 VDC, provides operation in accordance with NAMUR
- Power supply outputs provide: 5 VDC / 5.5 A and 3.3 VDC / 6.5 A
- Enhanced power-fail prediction and shutdown procedures
- LED indication for power supply status and operating status of the AC 800F
- Short circuit proof, current limited
- 20 ms backup energy for use in the event of primary power failure, according to NAMUR
- G3 compliant Z variant available

## Technical data

Technical data SD 812F	
Input voltage	24 VDC, 2 redundant inputs permissible range 19.2 - 32.5 VDC
Input current at nominal load	1.7 A at 24 VDC
Rated input power	41 W
Backup energy for the event of power failure	> 20 ms
Fuse	For each supply: subminiature fuse 3.15 AT, soldered
Output voltage	3.3 VDC ( $\pm 3\%$ ) typical 5 VDC ( $\pm 3\%$ ) typical
Output current	0.5 - 6.5 A to 3.3 V 0.5 - 5.5 A to 5.0 V
Current limit	Approx. 7.5 A Automatic return to normal operation after short circuit
Total output power	Max. 35 W
Weight	0.460 kg, 1.014 lbs

## LED displays

LED	Status	Description
Power		Internal supply voltage is available

LED	Status	Description
Failure	Off	Normal status
	Orange	Self test
	Flashing orange	Overtemperature occurred during operation
	Red	Hardware failure of the basic unit
	Flashing red	Software failure of the system
Run/Stop	Green	Processing active
	Flashing green	Process was stopped and is now started again
	Red	Processing inactive
	Flashing red	Process was active and is stopped now
	Orange	Self test
	Off	Software initialization
Prim/Sec	In case of redundancy please see the LEDs description in the manual "Mounting and Installation Instruction AC 800F". For non-redundancy the states are:	
	Orange	Self test
	Off	Normal status

## Operator controls

Control	Description
Run/Stop switch	Connected to LED
Toggle Prim/Sec	For redundancy. Toggles between primary and secondary AC 800F (operational on primary AC 800F only, and only if a secondary AC 800F is available)
Reset	Reset button press and hold > 4 s for coldstart

## Front panel connections

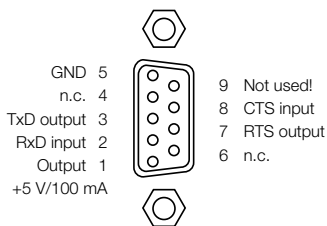

Control	Description
Power supply	Two connectors for 24 VDC, automatic input selection when used with single power supply
Diag	For diagnostics and optional radio-controlled clock 9-pin male connector

## 3.4.6 Ethernet interface

### EI 813F, 10BaseT

Name	Short description	Article no.
EI 813F	Ethernet Module 10BaseT (Twisted pair) To use together with PM 803F. Battery not included. Freelance V7.1SP2a or higher is mandatory.	3BDH000022R1

These communication modules provide Ethernet communications to the control network compliant with IEEE802.3 standard.

Communications module, compliant with 10BaseT shielded Twisted Pair (STP, cable category 3, 4 or 5 advanced)

#### Features:

- IEEE802.3 Ethernet standard
- Provides 10BaseT compliant communication (10Mbit)
- 32-bit data bus
- Transmission rate 10 Mbit/s
- Direct memory access to main memory, < 4% CPU overhead for operation
- Optional battery for redundant battery backup of main memory
- G3 compliant Z variant available

### Technical data

Technical data EI 813F	
Rated voltage	3.3 V / 5 V, $\pm 3\%$ , from CPU board
Power consumption	Max. 1.2 W
STP	10BaseT cable category 3, 4 or 5 advanced
RAM and real-time-clock buffering time	PM 803F:
New battery inserted	$\geq 10$ days
After "Low" warning	$\geq 5$ hours
Battery	3.6 V lithium battery, 950 mAh (has to be ordered separately)
Weight	Approx. 0.150 kg, 0.33 lbs (without battery)

## LED displays

LED	Status	Description
Status	Off	No supply voltage, module is isolated
	Green	Power supply on, module identified and ready to operate as configured
	Orange	Power supply on, module identified and either: <ul style="list-style-type: none"> <li>- Normal transitory state after module startup</li> <li>- Configuration mode of Boot Loader</li> </ul>
	Orange flashing	Power supply on, module identified; module not connected to proper bus structure
	Red	Power supply on and either: <ul style="list-style-type: none"> <li>- Module not yet identified (normal for short time during module startup)</li> <li>- Error occurred during module test</li> </ul>
Battery (PM 803F)	Off	AC 800F is active, EI 812F not active => buffering from power supply module
		AC 800F is off (no watchdog of the batteries voltage) => buffering from battery
		During battery recovery or start-up phase
	Orange	Warning: battery low, no battery inserted, insufficient electrical contact etc.
	Green	Battery inserted and data protection provided

3

## Front panel connections

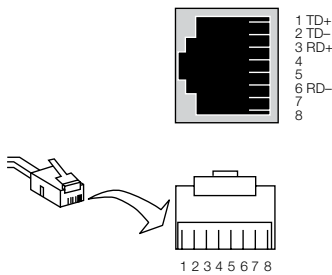

Control	Description	
RJ-45 female connector (shielded)		
There are two integrated LED's indicating the current communication status. The LEDs are not labeled but can be identified by their color.		
The upper yellow LED indicates the link state; the lower green LED indicates active communication.		
LED 10BaseT link	Off	No active link. No communication possible.
	Static yellow	Active link. communication possible.
LED 10BaseT active	Off	No communication.
	Flashing green	Communication

## 3.4.7 Fieldbus interface modules

### CAN-3 module FI 810

Name	Short description	Article no.
FI 810F	Fieldbus Module, CAN (triple channel) for rack I/O To use together with PM 803F.	3BDH000030R1

The FI 810F module provides connectivity to the Freelance rack I/O - up to 5 racks can be connected. It provides functionality according CAN 2.0 specification and supports baud rates up to 1 MBd. All interfaces are electrically isolated and support redundant operation in conjunction with a second AC 800F.

Only one FI 810F module may be plugged per AC 800F. The slot of the FI 810F module has to be F1

#### Features:

- 3-channel CAN modules
- Transmission rate: up to 1 MBd
- Module can be removed or inserted during operation
- Redundant operation, with redundant AC 800F
- G3 compliant Z variant available

### Technical data

Technical data FI 810F	
Rated voltage	5 V, $\pm$ 3% from basic unit
Power consumption	1.6 W - 2.6 W, depending from communication
Channel supply:	
Rated voltage	5 V, $\pm$ 10%
Power consump. per channel	0.15 W, when idling 0.30 W, during communication
Weight	Approx. 0.145 kg, 0.32 lbs

### LED displays

LED	Status	Description
Status	Off	No supply power, module is isolated
	Green	Module is active and working properly
	Orange	Module has been identified by AC 800F, but has not yet been activated
	Red	Module powered up, but not yet identified, or an error has occurred
RxD0	Green	Receive data on channel 0
TxD0	Green	Transmit data on channel 0
RxD1	Green	Receive data on channel 1
TxD1	Green	Transmit data on channel 1
RxD2	Green	Receive data on channel 2
TxD2	Green	Transmit data on channel 2

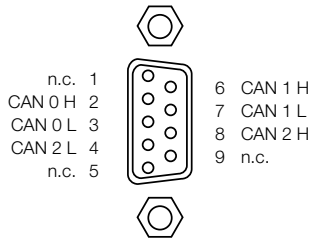

## Front panel connections

### Front panel connections

CAN 3 9-pin female connector



## Serial module FI 820F

Name	Short description	Article no.
FI 820F	Fieldbus Module, Serial (dual channel) To use together with PM 803F.	3BDH000031R1

3

The FI 820F module provides connectivity to a variety of serial fieldbuses and serial protocols. Standard protocol is MODBUS

By using different connection cables the physical interface can easily be selected: RS485 (half duplex), RS422 (full duplex) or RS232. All interfaces are electrically isolated and support redundant operation in conjunction with a second AC 800F.

### Features:

- Provides 2 serial interfaces
- Transmission rates up to 38.4 kBd configurable
- Physical interfaces RS485, RS422, RS232 selectable
- Electrical isolation
- Module can be removed or inserted during operation
- Redundant operation, with redundant AC 800F
- G3 compliant Z variant available

## Technical data

Technical data FI 820F	
Rated voltage	5 V, $\pm 3\%$ from basic unit
Power consumption	1.6 W - 2.6 W, appending from communication
Channel supply:	
Rated voltage	5 V, $\pm 10\%$
Power consump. per channel	0.15 W, when idling 0.30 W, during communication
Output voltage for termination (Vcc_Term)	
Rated voltage	5 V, $\pm 10\%$
Max. output current	20 mA
Weight	Approx. 0.145 kg, 0.32 lbs

## LED displays

LED	Status	Description
Status	Off	No supply power, module is isolated
	Green	Module is active and working properly
	Orange	Module has been identified by AC 800F, but has not yet been activated
	Red	Module powered up, but not yet identified, or an error has occurred
RxD0	Green	Receive data on channel 0
TxD0	Green	Transmit data on channel 0
RxD1	Green	Receive data on channel 1
TxD1	Green	Transmit data on channel 1

3

## Front panel connections

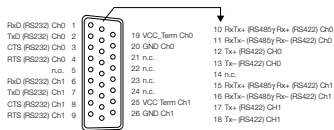

### Front panel connections

Serial - 26-pin female connector

## Profibus module FI 830F

Name	Short description	Article no.
FI 830F	Fieldbus Module, PROFIBUS-DP To use together with PM 803F.	3BDH000032R1

The FI 830F module interfaces to the Profibus fieldbus. It provides functionality according to the PROFIBUS-DP V1 standard (DIN 19245 amendment 1) and supports baud rates up to 12 MBd. The module is the master on the Profibus line and allows connecting up to 126 Profibus slaves. Configuration and parameterization is carried out completely with Freelance – no additional external configuration tools are required.

Line redundancy can be achieved using an external device (RLM 01) which drives two Profibus lines in parallel. In conjunction with a second AC 800F the module can also operate in a redundant-master mode without limiting any other feature. See also chapter “3.4.2 AC 800F redundancy concept” on page 32.

### Features:

- PROFIBUS-DP Module (DIN 19245)
- Transmission rate up to 12 MBd
- Supports up to 126 slaves
- Physical interface: RS485
- Electrical isolation
- Shared memory (256 KB) onboard, to minimize the use of basic unit memory
- Module can be removed or inserted during operation
- Redundant operation, with redundant AC 800F
- G3 compliant Z variant available



## Technical data

### Technical data FI 830F

Power consumption	In the active state, depends on the communication cycle time: 2.8 W
Max. output current	20 mA for bus termination / repeater supply
Output voltage	5 V, $\pm 5\%$
Overvoltage protection	+7.5 V / -5 V either transmission line to GND
Weight	Approx. 0.150 kg, 0.33 lbs

## LED displays

LED	Status	Description
Status	Off	No supply power, module is isolated
	Green	Module is active and working properly
	Orange	Module has been identified by AC 800F, but has not yet been activated
	Red	Module powered up, but not yet identified, or an error has occurred
Busy	Off	Module is in passive state on the Profibus
	Green	Module has token and, thus, is acting as the master

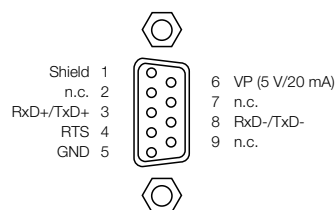

## Front panel connections

### Front panel connections

Profibus 9-pin female connector (DIN 41652)

## FF / HSE module FI 840F

Name	Short description	Article no.
FI 840F	Fieldbus Module, FF HSE To use together with PM 803F. UL certified. Freelance V7.1SP2a or higher is mandatory.	3BDH000033R1



The FI 840F is a high speed ethernet fieldbus module designed for fast data exchange in production engineering with decentralized peripherals.

The FF / HSE module FI 840F is a Fieldbus Foundation-(FF)-Master. Using the Freelance it is possible to configure diverse Fieldbus Foundation devices.

The FF / HSE module FI 840F is designed to connect the AC 800F to a FF / HSE network. It can be mounted on slots F1...F4. It is used if high transmission rates are required or shall be made available for future use. FF / HSE wiring is always a point-to-point connection. Therefore a networks with more than two nodes always requires network switches or hubs.

#### Features:

- ARM-CPU with integrated Ethernet controller, 32-bit data bus, 32-bit address bus
- Flash EPROM for module CPU and protocol software
- Software / firmware update without EPROM exchange
- Separate memory for module CPU
- Shared memory for data exchange between main processor and module CPU. Data protection by parity check
- Automatic detection if 10BaseT or 100BaseTX is connected
- Electrical isolation for TP interface
- ESD protector on RJ45 socket
- Serial interface / Manchester encoder for generating a serial bit stream
- EEPROM for configuration data and diagnostic data memory independent from battery buffering
- Isolator for electrical isolation of the bus signals
- RJ45 connector with two link LEDs
- G3 compliant Z variant available

## Technical data

<b>Technical data FI 840F</b>	
Rated voltage	5 V $\pm$ 3 % 3.3 V $\pm$ 3 % and 2.5 V $\pm$ 5 %
Power consumption	In the active state, 1.4 W - 2.1 W depending on communications load
Module memory	8 MBytes synchronous dynamic RAM
Shared memory	1 MByte synchronous static RAM used for data exchange between CPU board and module
Firmware memory	2 MByte Flash EPROM, 32-bit word length, capable of programming in the system and direct programming from AC 800F CPU board
EEPROM	Serial 16 kbit EEPROM, write cycles $\geq 10^7$ buffering time $\geq 10$ years
Weight	Approx. 0.150 kg, 0.33 lbs
<b>Static characteristics</b>	
Power consumption	Max. 2.1 W
Medium	100BaseTx cable, category 5
Max. segment length	100 m
<b>Static characteristics</b>	
Max. number of nodes per segment	2
<b>Dynamic characteristics</b>	
Transmission rate	10 Mbit/s or 100 Mbit/s

## LED displays

LED	Status	Description	
State	Off	No voltage applied, module is separated	
	Green	Power on, module is identified and ready for operation according to the configuration	
	Orange	Power on	Module has been identified by AC 800F
		Intermediate state during start-up	Configuration mode of the boot loader
		Flashing orange	Power on, module has been identified by AC 800F. Module is not connected to corrected bus physics
	Red	Power on	Module not yet identified (on a short-term basis during startup)
An error has occurred during module test			

3

## Front panel connections

### Front panel connections

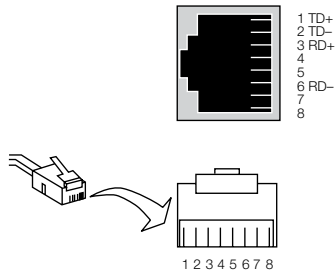

RJ-45 female connector (shielded)

There are two integrated LEDs indicating the current communication status. The LEDs are not labeled but can be identified by their color. The upper yellow LED indicates the transmission rate, the lower green LED indicates the communication state.

LED FF / HSE Speed	Off	Module has detected 10 Mbit/s data connection.
	Static yellow	Module has detected 100 Mbit/s data connection
LED FF / HSE Link	Off	No active link, neither 10Mbit nor 100 Mbit. No communication possible.
	Static green	Active link. Communication possible. No data transfer.
	Flashing green	Active link. Communication possible.

## 3.4.8 Coated and G3 compliant hardware

G3 compliant components are protected with a special coating against corrosive gases. The following Freelance ISA71.04 G3 compliant components can be ordered under the same conditions as any ordinary Freelance component. G3 compliance for AC 800F requires exclusively use of –Z components. AM 810F-Z serves for closing unused slots and the behind system plug.

G3 compliant components are identified by “Z” added to the module name, for example AC 800F-Z-4 MB

### Base units

Name	Short description	Article no.
PM 803F-Z	Base Unit 16 MB, battery-buffered RAM  Coated and G3 compliant version. Without operating system. The operating system has to be loaded during software installation. With special Contact Ledge RW 855F. Software V7.1SP2a or higher is mandatory.	3BDH000530Z1

### Power supplies

Name	Short description	Article no.
SA 811F-Z	Power Supply 115/230 VAC  Coated and G3 compliant version. To use together with PM 803F-Z. Software V7.1SP2a or higher is mandatory.	3BDH000013Z1
SD 812F-Z	Power Supply 24 VDC  Coated and G3 compliant version. To use together with PM 803F-Z. Software V7.1SP2a or higher is mandatory	3BDH000014Z1

### Ethernet interface module

Name	Short description	Article no.
EI 813F-Z	Ethernet Module 10BaseT (Twisted pair)  Coated and G3 compliant version. To use together with PM 803F-Z. Battery not included. Software V7.1SP2a or higher is mandatory.	3BDH000022Z1

### Fieldbus interface modules

Name	Short description	Article no.
FI 810F-Z	Fieldbus Module, CAN (triple channel) for Rack I/O  Coated and G3 compliant version. To use together with PM 803F-Z.	3BDH000030Z1
FI 820F-Z	Fieldbus Module, Serial (dual channel)  Coated and G3 compliant version. To use together with PM 803F-Z.	3BDH000031Z1
FI 830F-Z	Fieldbus Module, PROFIBUS-DP  Coated and G3 compliant version. To use together with PM 803F-Z.	3BDH000032Z1
FI 840F-Z	Fieldbus Module, FF HSE  Coated and G3 compliant version. To use together with PM 803F-Z.	3BDH000033Z1

## Auxiliary modules

Name	Short description	Article no.
AM 810F-Z	Cover Module G3 compliant station assembly requires AM 810F-Z for covering unused slots.	3BDH000030Z1
AM 811F-Z	Battery Module Coated and G3 compliant version. To use together with PM 803F-Z Without battery SB 808. Software V7.1SP2a or higher is mandatory.	3BDH000050Z1

## 3.4.9 Accessories

### 3.4.9.1 Battery modules and holder

Name	Short description	Article no.
SY 809F	Battery Holder Without battery SB 808F.	3BDH000042R1
SB 808F	Battery for RAM buffering, 2 pcs.	3BDM000199R1



### AC 800F battery module

Name	Short description	Article no.
AM 811F	Battery Module To use together with PM 803F Without battery SB 808. Freelance V7.1SP2a or higher is mandatory.	3BDH000050R1

The battery module can be used in non-redundant controllers with only one Ethernet module to increase the buffering time.

**Features:**

- Provides battery backup
- Enables redundant battery energy backup on the AC 800F
- G3 compliant Z variant available

## Technical data

Technical data AM 811F	
Rated voltage	3.3 V / 5 V ±3%, from CPU board
Power consumption	Approx. 0.28 W
Battery	3.6 V lithium battery, 950 mAh (included in delivery)
Low battery signaling	≤ 3.2 V
RAM and real-time-clock buffering time	PM 803F:
New battery inserted	≥ 10 days
After "Low" warning	≥ 5 hours
Weight	Approx. 0.150 kg, 0.33 lbs without buffer battery Approx. 0.170 kg, 0.375 lbs with buffer battery

## LED displays

LED	Status	Description
Status	Off	No supply voltage, module is isolated
	Green	Power supply on, module identified and ready to operate as configured
	Orange	Power supply on, module identified and either: - Normal transitory state after module startup - Configuration mode of Boot Loader
	Red	Module power supply on and either: - Module not yet identified (normal for short time during module startup) - Error occurred during module test
Battery (PM 803F)	Off	AC 800F is active, AM 811F not active => buffering from power supply module AC 800F is off (no watchdog of the batteries voltage): => buffering from Battery.
	Orange	During battery recovery or start-up phase
	Red	Warning: battery low, no battery inserted, insufficient electrical contact etc.
	Green	Battery inserted and data protection provided.

### 3.4.9.2 Front panel

Name	Short description	Article no.
AM 895F	Front Panel, 4 pcs Covering unused slots of AC 800F.	3BDH000044R1

### 3.4.9.3 Power supply accessories

Name	Short description	Article no.
TK 807F	Supply Cable 115 / 230 VAC, ferrules, 2 m For SA 811F.	3BDM000210R1
TK 808F	Supply Cable 115 / 230 VAC, Euro plug, 2 m For SA 811F.	3BDM000211R1
TK 809F	Supply Cable 115 / 230 VAC, US plug, 2 m For SA 811F.	3BDM000212R1
TK 802F	Supply Cable 24 VDC, ferrules, 2 m For SD 812F.	3BDM000213R1

3

### 3.4.9.4 Cables

Name	Short description	Article no.
TK 831F	CAN Cable (3 channel), integral connectors, 0.5 m 3 x 2 x 0.25 mm <sup>2</sup> , Identical with DFA 031. Connection FI 810F to Terminal Block TB 870F.	3BDM000100R1
TK 811F	CAN Cable, open end, ferrules, 3 m 3 x 2 x 0.25 mm <sup>2</sup> , Identical with DFA 011. Connection FI 8x0F to Terminal Block TB 870F.	3BDM000103R1
TK 821F	Serial Cable (2 channel), integral connectors, 0.5 m Identical with DFA 021. Connection FI 820F to Terminal Block TB 870F.	3BDM000150R1
TK 891F	Diagnostics Cable, 5 m Identical with DSU 141.	3BDM000201R1
TK 890F	Diagnostics Cable, 10 m Identical with DSU 141.	3BDM000202R1

### 3.4.9.5 Clips, Clamps and Miscellaneous

Name	Short description	Article no.
TB 870F	Terminal Block, for serial interface	3BDM000160R1
RW 856F	Mounting Accessory, for enforced wall mounting	3BDM000190R1
RY 885F	Grounding Strap, 2 pcs.	3BDM000169R1
TV 821F	Clip for shielding, 6 mm, 5 pcs.	3BDM000171R1
TV 822F	Clip for shielding, 16 mm, 5 pcs.	3BDM000172R1
TV 823F	Clip for shielding, 16..25 mm, 5 pcs.	3BDM000173R1
TV 824F	Clip for shielding, 23..35 mm, 5 pcs.	3BDM000174R1
TV 825F	Clip for shielding, 25..40 mm, 5 pcs.	3BDM000175R1
TV 831F	Clamp-type terminal, 3..10 mm, 5 pcs.	3BDM000180R1
TV 832F	Clamp-type Terminal, 16...20 mm, 5 pcs.	3BDM000181R1

## 3.5 The controller AC 700F



3

The AC 700F controller comes in a really small footprint and high signal density of S700 I/O. The S700 I/O modules are directly plugged to the CPU module or can be used as remote I/O via Profibus. A maximum of eight modules can be connected to one controller. 3rd party I/O's can be connected via a MODBUS ASCII / RTU serial bus or via Profibus. AC 700F now also offers expanded flexibility via a pluggable SD card for controller backup and firmware update.

AC 700F is based on hardware that is successfully used as PLC in practice for years in factory automation. The AC 700F controller, as a member of Freelance, has numerous advantages over a PLC based solution: The compact process control system simplifies engineering, commissioning, and maintenance of the automation system. Visualization is directly incorporated into the engineering, making configuration particularly straightforward. Small or distributed plant components can be implemented cost effectively by using AC 700F. The competitive advantage is clear: the same engineering, operation and maintenance method for all plant components hand in hand with the well-known ease of use of Freelance.

### 3.5.1 Hardware and certificates

AC 700F comes with a modular design. The base elements are different types of terminal units, for the CPU module, for the FBP interface module, and for S700 I/O modules. Both, screw type and spring type terminal units are available. The modules can be easily plugged to the terminal units and then the terminal units can be plugged one to the other. The entire controller is then mounted on a DIN rail.

#### Certificates

The AC 700F controller has the following certificates:

- CE, GL, UL, ISO 9001.

#### Technical data

The CPU and the local S700 I/O modules communicate very fast. I/O scan times of 2 ms are possible. Short circuit and line break detection is realized for each channel.

The AC 700F controller is designed according to the EN 61131-2 / IEC 61131-2 standards. Data that differ from the IEC 61131 standards are caused due to the high requirements of Maritime Services.

#### Environmental conditions

The temperature range of AC 700F and S700 I/O extends from 0 °C to 60 °C / 32-140 °F.

##### Temperature ranges and other environmental conditions

Ambient temperature	Operating:	Temperature range: 0 °C (32 °F) ..+60 °C (140 °F) With FieldbusPlug: 0 °C (32 °F) ..+55 °C (131 °F)  Highly recommended mounting: horizontally  <b>Vertical mounting:</b> is possible, however, derating considerations should be made to avoid problems with poor air circulation and the potential for excessive temperatures. Temperature range: 0 °C (32 °F) ..+40 °C / 104 °F 50% output load derating
	Storage:	-25 °C (-13 °F)...+75 °C (167 °F)
	Transport:	-25 °C (-13 °F)...+75 °C (167 °F)



### Temperature ranges and other environmental conditions

Ambient temperature for the battery	Operating:	0 °C (32 °F)...+60 °C (140 °F)
	Storage:	-20 °C (-4 °F)...+60 °C (140 °F)
	Transport:	-20 °C (-4 °F)...+60 °C (140 °F)
Humidity		Maximum 95%, without condensation
Air pressure	Operating:	> 800 hPa / < 2000 m
	Storage:	> 660 hPa / < 3500 m

## Mechanical stress

### Mechanical stress and mounting

Mounting	Horizontal
Degree of protection	IP 20
Housing	According to UL 94
Vibration resistance according to EN 61131-2	All three axes 2 Hz...15 Hz, continuous 3.5 mm (0.1379 inch) 15 Hz...150 Hz, continuous 1 g (0.04 oz) (4 g (0.14 oz) in preparation)
Shock test	All three axes 15 g (0.53 oz), 11 ms, half-sinusoidal
Mounting of the modules	DIN-rail according to DIN EN 50022, 35 mm (1.38 inch), depth 7.5 mm (0.2955 inch) or 15 mm (0.591 inch), mounting with screws of type M4, fastening torque 1.2 Nm

3

## Electromagnetic compatibility

### Electromagnetic compatibility / standards

2004/108/EC	Complies with the European directive
EN 61000-6-2	Electromagnetic compatibility (EMC) – Generic standards, Immunity for industrial environments
EN 61000-6-4	Electromagnetic compatibility (EMC) – Generic standards, Emission standard for industrial environments
2006/95/EC	Low Voltage Directive

## Electric data

### Electric data

#### Voltages according to EN 61131-2

Process- and Supply-voltage	24 VDC (-15 %, +20 % without ripple)
Absolute limits	19.2 V...30 V incl. Ripple (see below)
Ripple	< 5 %
Protection against reverse polarity	10 s

#### Permissible interruptions of power supply as per EN 61131-2

DC supply	Interruption < 10 ms, time between 2 interruptions > 1 s, PS2
-----------	--

#### Creepage distances and clearances

The creepage distances and clearances meet the overvoltage category II, pollution degree 2.

#### Power supply units

Power supply units meeting the PELV specification should be used for powering the modules.

## Insulation test voltages

Routine Test, according to EN 61131-2			
Circuits against other circuitry	230 V	2500 V	High voltage pulse 1.2/50 $\mu$ s
	120 V	1500 V	
	120-240 V	2500 V	
24 V circuits (supply, 24 V inputs / outputs), if they are electrically isolated against other circuitry.		500 V	
COM interfaces, electrically isolated		500 V	
Ethernet		500 V	
24 V circuits (supply, 24 inputs / outputs), if they are electrically isolated against other circuitry		350 V	AC voltage during 2 seconds
COM interfaces, electrically isolated		350 V	
Ethernet		350 V	

3



## 3.5.2 Central processing unit PM 783F

Name	Short description	Article no.
PM 783F	<p>Central Processing Unit (2 MB)</p> <p>Without operating system. The operating system has to be loaded during software installation.</p> <p>Needs external 24 VDC power supply.</p> <p>Software version 9.2SP2 or higher is mandatory. For operation with previous versions, please refer to product update information 2PAA102068R0018.</p> <p>Terminal Base TB 711F and Battery TA521 are not included</p>	3BDH000364R0002

The Central Processing Unit (CPU) module is equipped with a high-performance processor for fast loop cycle times. It comes with on-board 100 Mbit/s Ethernet network connection used for communication between controllers, operator stations, and engineering tool. Two serial line interfaces complement the connectivity. One interface can be used for Modbus communication, while the other is used for diagnostics. For demanding applications, eight cyclic and priority driven tasks with adjustable cycle time can be configured, as well as a cyclic PLC type task, which runs as fast as possible. This multi-tasking scenario enables engineers to design applications that reflect all demands of process control, while at the same time balancing the CPU load. This keeps the resources needed in a project at the minimum.

The small front panel display shows status and diagnostic information directly at the module. Furthermore, you can lock the controller via the keys. This means, the controller can be blocked for downloads of application and firmware to enhance security. The status, if the controller is locked or unlocked is shown on the display.

## Technical data

Technical data PM 783F	
CPU	Freescale PowerPCTM
RAM	Program memory (battery backed up) 2 MB SRAM Internal memory 8 MB SDRAM, 4 MB FLASH ROM
Processing time for 1000 instructions	0.71 ms for binary instructions
	0.84 ms for word instructions
	1.36 ms for floating point instructions

### Technical data PM 783F

Max. number of I/O modules on I/O bus (direct I/O)		8
Power supply		CP-C 24 / 5.0, power supply, 5 A / 24 VDC output CP-C 24 / 10.0, power supply, 10 A / 24 VDC output
Max. power dissipation within the module		10 W
Current consumption from 24 VDC		80 mA (max)
Inrush current at 24 VDC		1 A <sup>2</sup> s
Data backup source		Lithium battery
Data buffering time at 25 °C / 77 °F		Approximately 1.5 years
Battery low indication		Warning indication issued about 2 weeks before the battery charge becomes critical
Real-time clock, with battery backup		Yes
Multitasking program execution	Cyclic	8 tasks
	Cyclic (as fast as possible)	1 PLC type task
	Event driven	Upon any of these events: "Run, Stop, Warm start, Cold start, Error"
Serial interface "SER" (COM1) (see Figure 5 of Terminal Base TB 711F)	Physical link:	Configurable for RS-232 or RS-485 (from 1200 bps to 38400 bps)
	Connection:	Pluggable terminal block, spring connection
	Usage:	Modbus - ASCII (Master / Slave) - RTU (Master / Slave) - IEC 60870-5-101 Telecontrol protocol
Serial interface "DIAG" (COM2) (see of Terminal Base TB 711F)	Physical link:	RS-232
	Connection:	SUB-D female connector
	Usage:	For diagnostics
Onboard network interface	Connection:	1 x Ethernet (RJ45) 100 Mbit/s
	Usage:	- Modbus TCP - Telecontrol IEC 60870-5-104
LEDs, LCD display, 8 function keys		For RUN / STOP switch-over, status displays and diagnostics
Weight (CPU without Terminal Base)		150 g / 5.29 oz.
Dimensions (CPU without Terminal Base)	Width	67.5 mm, 2.66 inches
	Height	76 mm, 2.99 inches
	Depth	54 mm, 2.13 inches

### 3.5.3 PROFIBUS module CI 773F

Name	Short description	Article no.
CI 773F	Communication Interface, PROFIBUS DP Master DP-V0/V1, 12 MBit/s D-Sub terminal, 9-pole Software version 2013SP1 or higher is mandatory Gray housing Requires the Fieldbus slot on PM 902F or Terminal Base TB 711F. UL approvals pending	3BDH000395R0005

More details see "Communication Interface CI 773F" on page 21.

### 3.5.4 CPU terminal base TB 711F

Name	Short description	Article no.
TB 711F	CPU Terminal Base 24 VDC, 1x Coupler slots, Ethernet RJ45.	3BDH000365R0001

#### Technical data TB 711F

Connection of the 24 VDC process voltage	With a 5-pole removable terminal block
Slots	1 CPU, 1 Communication module (not used currently)
Interfaces	Field I/O: 1 for I/O-Bus Serial ports: 2 ("SER" (COM1), "DIAG" (COM2)) Networking: 1 Ethernet (RJ45) Profibus Master port
Weight	175 g / 6.17 oz.
Dimensions (with CPU inserted)	Width 95.5 mm, 3.75 inches Height 135 mm, 5.31 inches Depth 75 mm, 2.95 inches

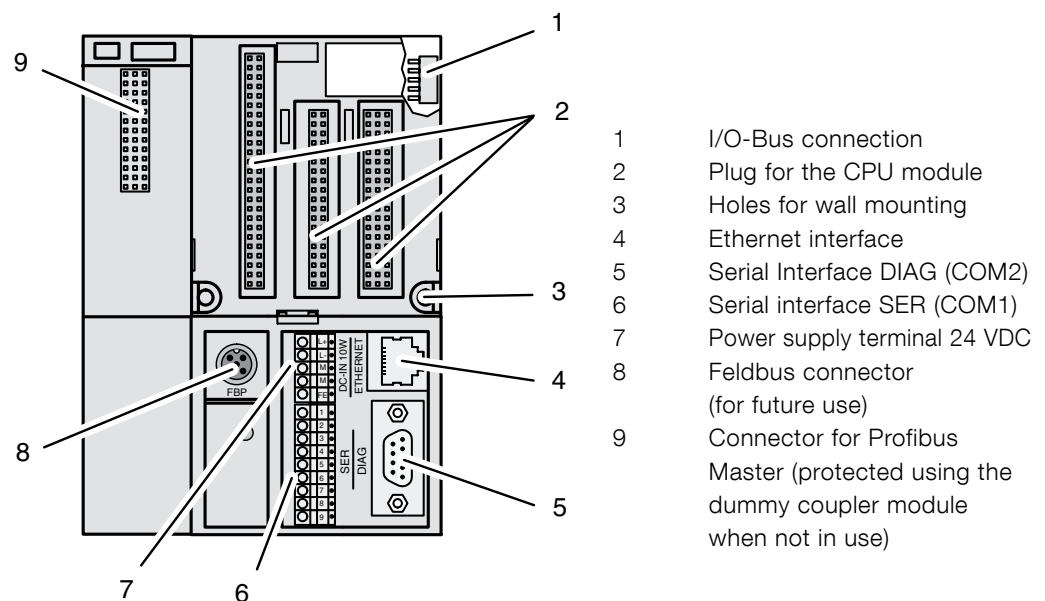

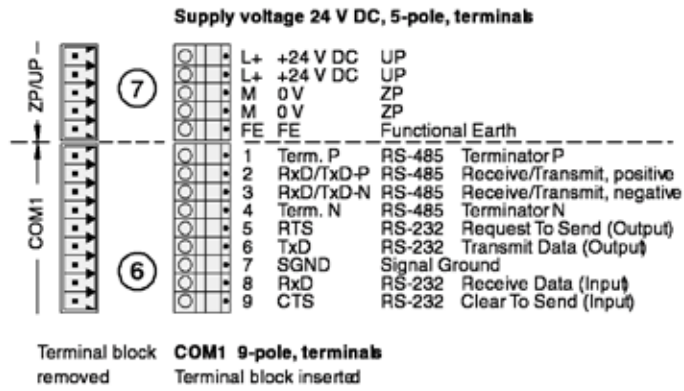
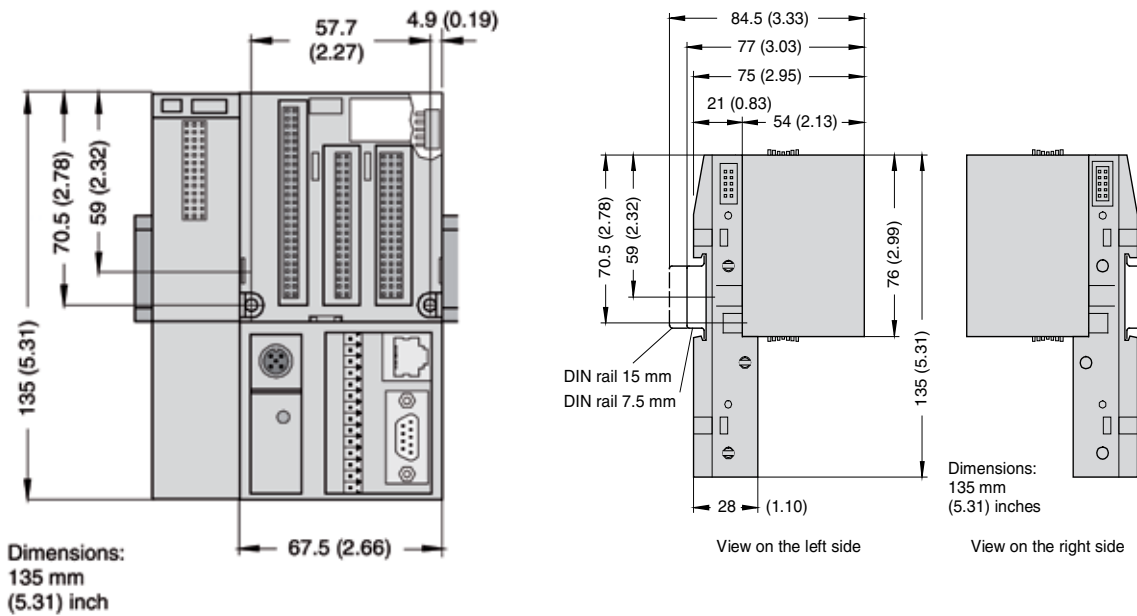

Figure 5: Terminal assignment for supply voltage (24 VDC) and the serial interface SER (COM1)

### 3.5.4.1 Dimensional drawings CPU Terminal Base



## 3.5.5 Accessories for CPU module

Name	Short description	Article no.
TK 701F	Diagnostic Serial Cable, Sub-D / Sub-D, 5 m / 16.4 ft.	3BDH000366R0001

Name	Short description	Article no.
TA521	Battery for RAM buffering Button Cell, Lithium For PM 783F	1SAP180300R0001

Name	Short description	Article no.
TA 724F	Dummy Coupler Module Empty module, to protect an unused coupler slot from dust and touch when AC 700F is used without a Profibus Master module. Is mounted on the CPU Terminal Base TB 711F.	3BDH000367R0001

Name	Short description	Article no.
TA526	Accessories for back-plate mounting, 10 pcs. With wall mounting of Terminal Bases and Terminal Units.	1SAP180800R0001

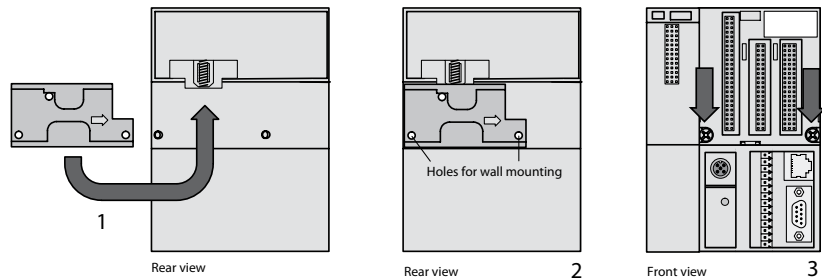
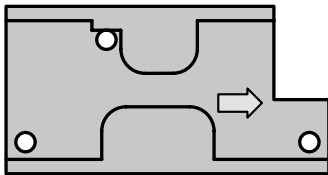

# Chapter 4 – Power supplies for AC 900F, AC 700F and S700 I/O

4.1 Power supply modules. . . . .	58
4.2 Accessories for power supplies. . . . .	60

## 4.1 Power supply modules

### Power supplies



CP-C 24/5.0



CP-C 24/10.0

Name	Short description	Article no.
CP-C 24 / 5.0	Power Supply, 5 A / 24 VDC Output 110-240 VAC / 100-350 VDC Input. For extended protection against accidental contact, mounting in a cabinet is recommended.	3BDH001040R0001
CP-C 24 / 10.0	Power Supply, 10 A / 24 VDC Output 110-240 VAC / 100-350 VDC Input. For extended protection against accidental contact, mounting in a cabinet is recommended.	3BDH001041R0001

### Technical data

Technical data CP-C 24 / 5.0 / 10.0		
Power dissipation	CP-C 24 / 5.0:	typically < 15 W
	CP-C 24 / 10.0:	typically < 29 W
Efficiency	Typically 89 %	
MTBF	500.000 h	
Dimensions W x H x D	CP-C 24 / 5.0:	56.5 x 130 x 137 mm / 2.22 x 5.12 x 5.39 inch
	CP-C 24 / 10.0:	90 x 130 x 137 mm / 3.54 x 5.12 x 5.39 inch
Weight	CP-C 24 / 5.0:	approx. 0.96 kg / 2.11 lb
	CP-C 24 / 10.0:	approx. 1.34 kg / 2.95 lb
Mounting	DIN-rail (DIN EN 50022) snap mechanism	
Mounting position	Horizontal	
Minimum distance between devices	Horizontal 10 mm (0.39 inch)	
	Vertical 80 mm (3.15 inches)	
Degree of Protection	IP 20 Protection class ( EN 61140)	
Environmental data		
Ambient temperature range	Operation	-25 °C (-13 °F)...+70 °C (158 °F)
	Full load	0 °C (32 °F)...+60 °C (140 °F) (without derating)
	Storage	-40 °C (-40 °F)...+85 °C (185 °F)
Damp heat (IEC/EN 60068-2-3)	93 % at +40 °C (104 °F), no condensation	
Pollution category (EN 50178)	24 VDC	
Climatic category (IEC/EN 60721)	3K3	
Isolation data		
Insulation voltage	Input	3 kVAC (type test), 1.2 kVAC (routine test)
	Input / PE	1.5 kVAC (type test), 1.2 kVAC (routine test)
	Output / PE	350 VAC (routine test) 28 mm (1.1 inch)
Input (L,N)		
Rated input voltage $V_{IN}$	110 - 240 VAC	
Input voltage range	85 - 264 VAC, 100 - 350 VDC (external fuse)	
Frequency range AC	47 - 63 Hz	
Current consumption at 110 - 240 VAC	Approx. 2.2 - 1.2 A	
Power consumption	Typ. 135 W	



### Technical data CP-C 24 / 5.0 / 10.0

Inrush current / I <sub>2t</sub> (cold start)	< 23 A / approx. 0.9 A <sup>2</sup> s	
Power failure buffering at rated load	Min. 100 ms	
Starting time after applying supply voltage	Typ. < 100 ms	
Transient overvoltage protection	Varistors	
Internal input fuse (apparatus protection), not accessible	CP-C 24 / 5.0:	4 A (slow-acting)
	CP-C 24 / 10.0:	6.3 A (slow-acting)
Discharge current for PE	< 3.5 mA	
<b>Output (L+, L+, L-, L-)</b>	Short-circuit, no-load and overload proof	
Rated output voltage	24 VDC ±0.5 %	
Adjustment range of the output voltage	22 – 28 V	
Rated output power	CP-C 24 / 5.0:	120 W
	CP-C 24 / 10.0:	240 W
Rated output current I <sub>r</sub> at TA < 60 °C (140 °F)	CP-C 24 / 5.0:	5 A
	CP-C 24 / 10.0:	10 A
Peak output current (power reserve) at TA < 40 °C (104 °F)	CP-C 24 / 5.0:	7.25 A
	CP-C 24 / 10.0:	12.25 A
Resistance to reverse feed	Approx. 35 VDC	
Power Factor Correction (PFC)	Yes	
<b>Overload performance</b>		
Output characteristics	U/I curve with power reserve	
Current limitation at short circuit	CP-C 24 / 5.0:	Approx. 11 A
	CP-C 24 / 10.0:	Approx. 19 A
Protection against	short-circuit, open-circuit, overload	
Starting of capacitive loads	Unlimited	
<b>Standards and directives</b>		
Product standard	IEC/EN 61204	
Low Voltage Directive	2006/95/EC	
EMC directive	2004/108/EC	
Electrical safety	EN 50178, EN 60950, UL 60950, UL 508	
Protective low voltage	SELV (EN 60950)	
<b>Electromagnetic compatibility</b>		
Interference immunity	IEC/EN 61000-6-2	
Interference emission	IEC/EN 61000-6-3, Class B	
<b>Certificates</b>		
Declaration of conformity	CE	
Approvals	cULus, UL Class 1 Div 2 (Groups A, B, C, D), EAC	

## 4.2 Accessories for power supplies

Name	Short description	Article no.
CP-C MM	Messaging Module for CP-C, relay outputs The message module CP-C MM indicates the correct function of the power supply unit via LEDs and energized output relays. The module will be plugged at the front side of the power supply.	3BDH001043R0001

Name	Short description	Article no.
CP-A RU	Redundancy Unit If a fault occurs in the first power supply circuit, the total current requirement of all consumers can be completely covered by a second power supply unit, and the output circuits are decoupled by means of the redundancy unit CP-A RU.	3BDH001044R0001

Name	Short description	Article no.
CP-A CM	Control Module for Redundancy Unit CP-A RU	3BDH001045R0001

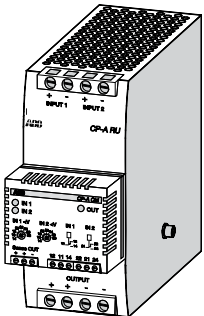
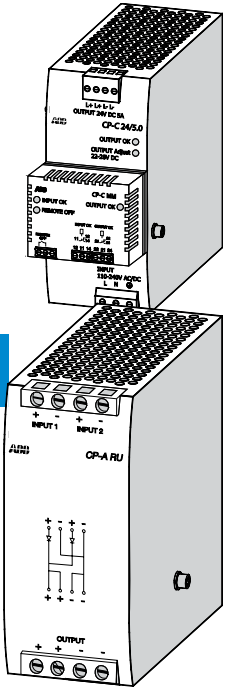

4

# Chapter 5 – I/Os

<b>5.1 Introduction to I/Os for Freelance</b>	<b>66</b>
<b>5.2 S700 I/O</b>	<b>67</b>
5.2.1 S700 I/O modules	68
5.2.2 Fieldbus interface module CI 741F	69
5.2.3 Fieldbus interface module DC 705F	71
5.2.4 Digital I/O Modules	72
5.2.5 Analog I/O Modules	94
5.2.6 Digital / analog I/O module	115
5.2.7 S700 I/O terminal units	121
5.2.8 S 700 I/O Accessories	126
<b>5.3 S800 Remote I/O</b>	<b>128</b>
5.3.1 Communication	128
5.3.2 S800 I/O (eA) modules	130
5.3.3 S800L (eA) modules	137
5.3.4 Power supplies	139
5.3.5 S800 I/O user documentation	140
<b>5.4 S900 Remote I/O</b>	<b>141</b>
5.4.1 Introduction to S900 I/O system	141
5.4.2 Redundant termination unit TU921S/B/N	142
5.4.3 Power supply SA920S/B/N	142
5.4.4 Digital I/O modules	143
5.4.5 Analog I/O modules	144
5.4.6 Field housing	148
5.4.7 Accessories for S900	150
5.4.8 Software	151

## 5.1 Introduction to I/Os for Freelance

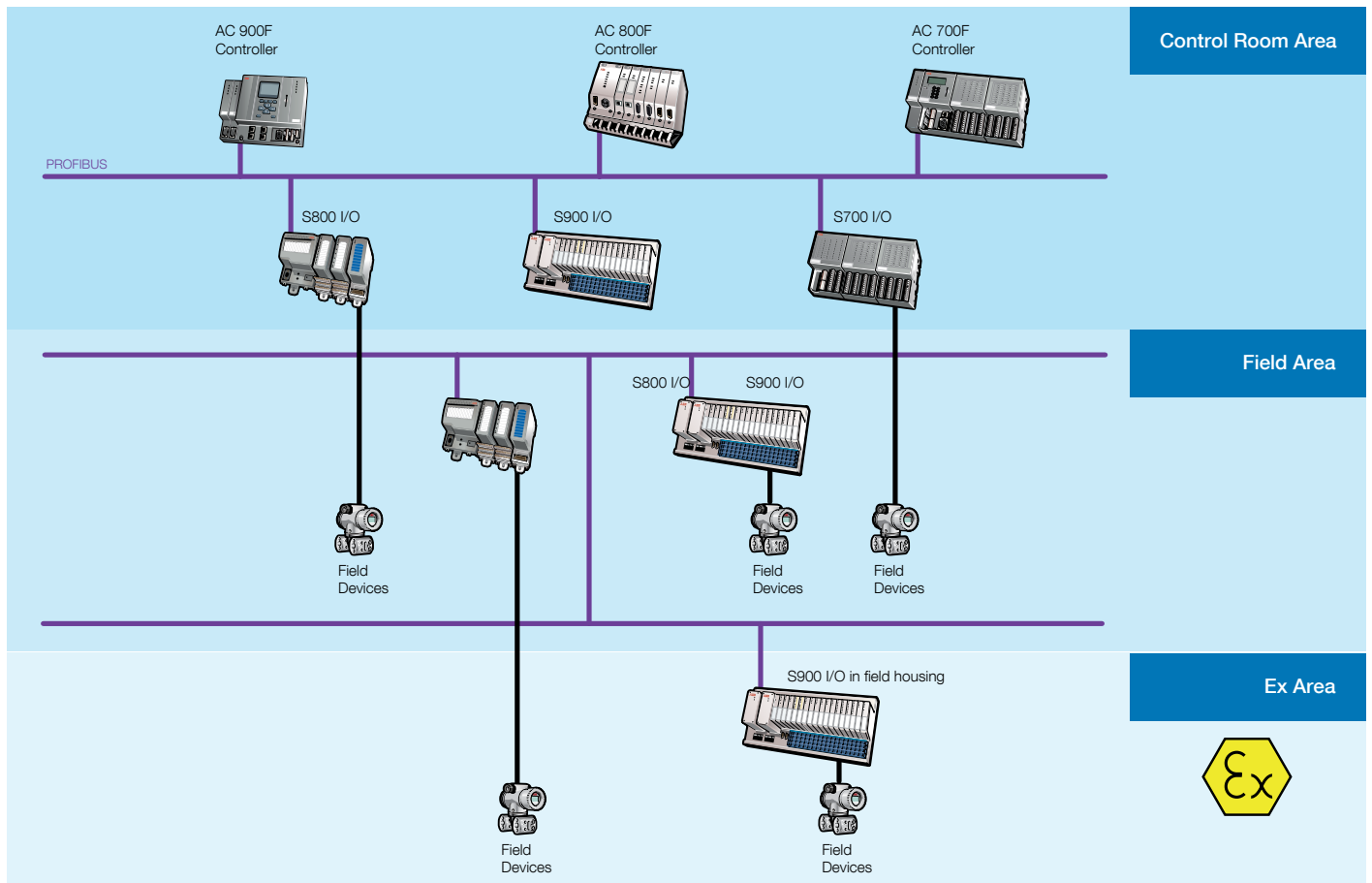

5

The following chapter will give you a brief overview about the Remote I/O systems S700, S800 and S900.

The picture above shows a sketch of a possible Profibus topology without going into detail. The controllers are assembled in the control room. Remote I/O systems can be assembled in the control room or directly in the field. Furthermore, S900 I/O can be placed locally in the field in hazardous area, depending on the customer's needs. Field devices are connected to the remote I/O systems. With AC 700F and AC 900F a subset of S700 I/O can be plugged as direct I/O to the right side of the controller.

Remote I/O systems can also be mounted locally in the field, near field devices. This type of installation reduces the costs for cabling from the field device to the system.

On-site assembly of the remote I/O systems is easy, as only a single cable is required for Profibus communication and just a suitable field housing is needed for mounting. This field housing usually has the IP66 degree of protection. Other devices such as fiber optic couplers, pneumatic valves, terminals, terminal blocks or additional electrical devices can also be mounted in such a field housing. This reduces both design, engineering and cabling costs.

In order for devices to be installed in hazardous areas, extra regulations and functional rules need to be considered in addition to the usual engineering rules.

All devices which are used in hazardous area have to be certified. The devices shall have a certificate for either Zone 1 or Zone 2. The S900 remote I/O system (S and B series) is suitable for installation in hazardous areas, see the table below:

Series	Assembly	Field devices / signals	Hazardous area approval
S	in Zone 1	in Zones 2, 1, and 0 (intrinsically safe signals)	ATEX Zone 1
B	in Zone 2	in Zones 2, 1, and 0 (intrinsically safe signals)	ATEX Zone 2
N	in safe areas	in safe areas	no

## 5.2 S700 I/O



S700 I/O can be used as direct I/O for AC 700F and AC 900 or as Profibus remote I/O for AC 700F, AC 800F, AC 900F or other Profibus Masters. Up to eight direct I/O modules can be connected to the fieldbus interface module.

One of the S700 I/O benefits is the small footprint – the modules are featured with a high packing density, several modules are available with inputs and outputs mixed in one module. Currently, 14 different module types are available covering a wide variety of applications



## 5.2.1 S700 I/O modules

The following table lists the entire set of S700 I/O modules. All modules can be used as remote I/O at Profibus DP. The indicated subset can be used as direct I/O together with the AC 700F and AC 900F controller.

Module Name	Type (Channel Groups)	Input Range	Output Range
DC 732F	16 DI, 16 DI/DO configurable	24V DC, 1-wire, standard binary signals, all signals share common ground	24 V DC, 0.5 A
AI 723F	16 AI , 12-Bit+Sign	0...10 V, -10...+10 V, 0/4...20 mA, Pt100/1000, Ni1000, DI	-
AX 722F	8 AI + 8 AO (2x4), 12 Bit+Sign	0...10 V, -10...+10 V, 0/4...20 mA, Pt100/1000, Ni1000, DI	0...10 V, -10...+10 V, 0/4...20 mA, Pt100/1000, Ni1000, DI, Ch 0-3: -10...+10 V, 0/4...20 mA; Ch 4-7: -10...+10 V
AO 723F	16 AO (2x8), 12 Bit+Sign	-	Ch 0-3: & 8-11: -10...+10 V, 0/4...20 mA, Ch 4-7 & 12-15: -10...+10 V
DX 722F	8 DI, 8 DO Relay	24 V DC	24 V DC, 110 V/ 230 V AC
DX 731F	8 DI, 4 DO Relay	110 V/ 230 V AC	24 V DC, 110 V/ 230 V AC
AI 731F	8 AI , 15 Bit+Sign	-50 mV...+50 mV, -500 mV...+500 mV, -1 V...+1 V, 0...10 V, -10 V...+10 V, 0 V...+5 V, -5 V...+5 V, 0...20 mA, 4...20 mA, -20...+20 mA, Pt100/1000, Ni1000, Cu50 (1.426), Cu50 (1.428), 0...50 kOhm, Thermocouple J K T N S Type, DI	-
DI 724F	32 DI	24 V DC, 1-wire, standard binary signals, all signals share common ground	-
AX 721F	4 AI + 4 AO, 12 Bit+Sign	0...10 V, -10...+10 V, 0/4...20 mA, Pt100/1000, Ni1000, DI	0...10 V, -10...+10 V, 0/4...20 mA
DA 701F	16 DI, 8 DC, 4 AI, 2 AO	24 V DC (for DI), 0...10 V, -10...+10 V, 0/4...20 mA, Pt100/1000, Ni1000, DI	24 V DC, 0.5 A (for DO), -10...+10 V, 0/4...20 mA
DC 705F	FBP Interface + 8 DI, 8 DC	24 V DC, 1-wire, this is the communication module for Profibus	24V DC, 0.5 A
AC 722F	8 AC, 12 Bit+Sign	24 V DC, 2-wire ...10 V, -10...+10 V, 0/4...20 mA, Pt100/1000, Ni1000, DI	24 V DC, 2-wire Ch 0-3: -10...+10 V, 0/4...20 mA, Ch 4-7: -10...+10 V
DC 722F	16 DC, 24 V DC	24 V DC (2/3-wire DI possible)	24 V DC, 0.5 A
DC 723F	24 DC, 24 V DC	24 V DC (2/3-wire DI possible)	24 V DC, 0.5 A
CD 722F	2 counter inputs, 2PWM, 2DI, 8DC	RS-422, 5-V-TTL, 24-V-totem-pole, 1-Vpp, SSI interface	PWM, 24V DC, 0.5 A, frequency (pulse) module

## 5.2.2 Fieldbus interface module CI 741F<sup>1</sup>

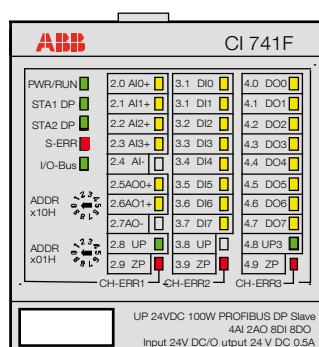

Name	Short description	Article no.
CI 741F	<p>Interface for S700 Remote I/O with Sub-D connector</p> <p>8 DI: 24 V DC</p> <p>8 DO: 24 V DC/0.5 A</p> <p>2 AI: <math>\pm 10</math> V, 0/4-20 mA, RTD, 24 V DC</p> <p>2 AO: <math>\pm 10</math> V, 0/4-20 mA</p> <p>1-wire, 24 V DC, 100 W</p> <p>Use with TU 709F/710F (terminal unit not included)</p> <p>– Fieldbus Interface module</p> <p>– Profibus remote I/O</p>	3BDH000396R0005

The CI 741F is used as communication interface for PROFIBUS communication. The bus is connected by the Sub-D connector on the TU 709F/710F terminal block. The module is characterized by the following features:

- PROFIBUS DP interface
- 2 analog inputs in one group (2.0 ... 2.4)
- 2 analog outputs in one group (2.5 ... 2.7)
- 8 digital 24 V DC inputs in one group (3.0 ... 3.7)
- 8 digital outputs in one group (4.0 ... 4.7)

You can use the standard PROFIBUS plug to connect the PROFIBUS DB fieldbus to the CI 741F and/or the corresponding TU 709F/710F terminal block.

### Environmental Conditions

Please refer to “3.5.1 Hardware and certificates” on page 54.

### Technical data

Functionality CI 741F	
Fieldbus interface	PROFIBUS DP, Sub-D female connector
Power supply of the I/O electronics	UP = 24 V DC (except for DO0 to DO7)
Power supply of the outputs DO0 to DO7 expansion modules attached	UP3 = 24 V DC
Address switch	Setting of the fieldbus address (hexadecimal)
LEDs	32 for system status, signal status, error messages and power supply
Power supply	UP, UP3 = 24 V DC
Potential separation	Module-wise
Digital inputs	8 24 V DC inputs
Digital outputs	8 outputs 24 V DC, 0.5 A

<sup>1</sup> in Preparation as successor of DC 705F

## Functionality CI 741F

Analog inputs	4 analog inputs that can be configured individually for: <ul style="list-style-type: none"><li>- unassigned (default setting)</li><li>- 0 ... 10 V, -10 ... +10 V</li><li>- 0/4 ... 20 mA</li><li>- Pt100, -50 ... +400 °C (2-wire)</li><li>- Pt100, -50 ... +400 °C (3-wire), requires 2 channels</li><li>- Pt100, -50 ... +70 °C (2-wire)</li><li>- Pt100, -50 ... +70 °C (3-wire), requires 2 channels</li><li>- Pt1000, -50 ... +400 °C (2-wire)</li><li>- Pt1000, -50 ... +400 °C (3-wire), requires 2 channels</li><li>- Ni1000, -50 ... +150 °C (2-wire)</li><li>- Ni1000, -50 ... +150 °C (3-wire), requires 2 channels</li><li>- 0 ... 10 V via differential inputs, requires 2 channels</li><li>- -10 ... +10 V via differential inputs, requires 2 channels</li><li>- digital signals (digital input)</li></ul>
Analog outputs	2 analog outputs that can be configured individually for: <ul style="list-style-type: none"><li>- unassigned (default setting)</li><li>- 0 ... 10 V, -10 ... +10 V</li><li>- 0/4 ... 20 mA</li></ul>
Resolution of the analog channels	Current/voltage: 12 bits plus sign Temperature: 0.1 °C



## 5.2.3 Fieldbus interface module DC 705F



Name	Short description	Article no.
DC 705F	Interface for Fieldbus Plug FBP 8 DI: 24 VDC 8 DI/DO: 24 VDC/0.5 A 1-wire, 24 VDC 100 W TU 705F /TU 706F (terminal unit not included)  – Fieldbus Interface module – Profibus remote I/O	3BDH000388R0001

The FBP Interface Module DC 705F is also used as a remote I/O module for Profibus. The bus connection is performed by a neutral FieldBusPlug interface, to which the FieldBusPlug PDP22 is plugged in. In addition FBP Interface Module DC 705F provides 16 I/O channels with the following features:

- 8 digital inputs 24 V DC in one groups (1.0...1.7)
- 8 digital inputs/outputs in one group (2.0...2.7), of which
  - each can be used as an input,
  - as a transistor output with short-circuit and overload protection with 0.5 A rated current or
  - as a re-readable output (combined input/output) and can be addressed accordingly.

The technical data correspond to the input and output values. The inputs and outputs are electrically isolated from the other electronic circuitry of the module. There is no potential separation between the channels.

### Environmental Conditions

Please refer to “3.5.1 Hardware and certificates” on page 54.

### Technical data

Functionality DC 705F	
Fieldbus	PROFIBUS DP via a neutral fieldbus plug interface
Digital inputs/outputs	8 digital inputs 24 V DC 8 digital inputs/outputs that can be configured individually as: digital input, 24 V DC digital output, 24 V DC 0.5 A re-readable output
Power supply of the module	Via the fieldbus plug
Address switches	For setting the field bus address (0 to 99)
Power supply of the I/O circuit	UP = 24 V DC
Potential separation	Module-wise
LED displays	22 for system status, signal status, error messages and power supply
External supply voltage	Via the terminals ZP and UP (process voltage 24 V DC)

## 5.2.4 Digital I/O Modules

### 5.2.4.1 Frequency input module CD 722F



Name	Short Description	Article No.
CD 722F	<p>Frequency input module</p> <p>2 Counter Inputs: 5/24 VDC, 1 Vpp sinus, fmax 300 kHz</p> <p>2 DO: 24 VDC/0,1 A, pulse width PWM</p> <p>2 DI: 24 VDC</p> <p>8 DI/DO: 24 VDC/0,5 A</p> <p>1/2-wire, 24 VDC 100 W</p> <p>TU 715F /TU 716F</p> <p>(terminal unit not included)</p> <p>– Profibus remote I/O</p>	3BDH000393R0001

5

It has the following features:

- 2 independent counting functions with up to 12 configurable modes (including incremental position encoder and frequency input up to 300 kHz)
- 2 independent PWM (pulse-width modulator) or pulse outputs with push- pull driver.
- Dedicated inputs/outputs for specific counting functions (e.g. touch, set, reset)
- All unused inputs/outputs can be used with the specifications of standard inputs/outputs range



This I/O module can only be used as Profibus remote I/O and not as direct I/O.

The technical data correspond to the input and output values. The inputs and outputs are electrically isolated from the other electronic circuitry of the module. There is no potential separation between the channels.

### Technical data

The technical data correspond to the input and output values. The inputs and outputs are electrically isolated from the other electronic circuitry of the module. There is no potential separation between the channels.

Functionality CD 722F	
Digital inputs/outputs	<p>24 V DC, dedicated inputs/outputs can be used for specific counting functions:</p> <p>Catch/touch operation, counter value stored in separate variable on external event (rising or falling edge)</p> <p>Set input to preset counter register with predefined value</p> <p>Set input to reset counter register</p> <p>End value output; the output is set when predefined value is reached</p> <p>Reference point initialization (RPI) input for incremental encoder initialization</p> <p>All unused inputs/outputs can be used with the specification of standard input/output range.</p>

## Functionality CD 722F

High-speed counter/encoder	<p>integrated, 2 counters (hardware interface with +24 V DC, +5 V DC, differential and 1 V<sub>pp</sub> sinus input) with up to 12 configurable operation modes:</p> <p>32 bits one counter mode</p> <p>16 bits two counter mode</p> <p>Incremental position encoder</p> <p>Absolute SSI encoder</p> <p>Time frequency meter</p> <p>Frequency input up to 300 kHz</p>
PWM/pulse outputs	<p>2 pulse-width-modulators or pulse outputs</p> <p>Output specification</p> <p>Push-pull output: 24 V DC, 100 mA max.</p> <p>Current limitation (thermal and over current)</p> <p>PWM specification</p> <p>Frequency from 1 Hz to 100 kHz</p> <p>Value from 0 to 100 %</p> <p>Pulse specification</p> <p>Frequency from 1 Hz to 15 kHz</p> <p>Pulse emission from 1 to 65535 pulses</p> <p>Number of pulses emitted indicator (0 to 100 %)</p> <p>Frequency specification</p> <p>Frequency output = 100 kHz when duty cycle set to 50 %</p>
Power supply for encoders	Two 5 V power supplies, max. 100mA
LEDs	For system displays, indicating signal statuses, errors and power supply
Internal power supply	Via I/O Bus
External power supply	Via the terminals UP(process voltage 24 V DC) and ZP (0 V DC)

## Technical Data CD 722F

Connection	Terminals 1.8,2.8,3.8 and 4.8 for UP (+24 V DC) and 1.9, 2.9, 3.9 and 4.9 for ZP (0V)
Protection against reversed voltage	Yes
Rated protection fuse on UP	10 A fast
Rated value	24 V DC
max. ripple	5 %
Current consumption	
From UP	0.07 A + max. 0.008 A per input + max. 0.5 A per output + 0.01 A for A, B and Z inputs
Via I/O Bus	Approx. 5 mA
Inrush current from UP (at power up)	0.04 A <sup>2</sup> s
Electrical isolation	Yes, per module

Technical Data CD 722F	
Max. power dissipation within the module	6 W (outputs not loaded)
Dimensions (without the Terminal Unit)	67.5 x 76 x 54 mm / 2.66 x 2.99 x 2.13 inches width x height x depth
Weight	125 g/ 4.41 oz.
Mounting position	Horizontal or vertical with limitations (output load per group 50 % at 40°C (104°F))
Cooling	The natural convection cooling must not be hindered by cable ducts or other parts in the mounting cabinet.

Technical data for the digital inputs/outputs if used as standard inputs	
Number of channels per module	2 + 8 configurable digital inputs/outputs
Reference potential for all inputs	Terminals 1.9...4.9 (Minus pole of the supply voltage, signal name ZP)
Electrical isolation	From the rest of the module
Indication of the input signals	1 yellow LED per channel, the LED is ON when the input signal is high (signal1)
Input type acc. to EN 61131-2	Type 1
Input delay (0->1 or 1->0)	typically 8 ms, configurable from 0.1...32 ms
Input signal voltage	24 V DC
signal 0	-3 V...+5 V
undefined signal	> +5 V...< +15 V
signal 1	+15 V...+30 V
Ripple with signal 0	within -3 V...+5 V*
Ripple with signal 1	within +15 V...+30 V
Input current per channel	
input voltage +24 V	typically 5 mA
input voltage +5 V	> 1 mA
input voltage +15 V	> 5 mA
input voltage +30 V	< 8 mA
Max. cable length	shielded 1000 m (3280.83 ft) unshielded 600 m (1968.50 ft)

\* Due to the direct connection to the output, the demagnetizing varistor is also effective at the input. This is why the difference between UPx and the input signal may not exceed the clamp voltage of the varistor. The varistor limits the voltage to approx. 36 V. Following this, the input voltage must range from -12 V to +30 V when UPx = 24 V and from -6 V to +30 V when UPx = 30 V.

**Technical data for the digital inputs/outputs if used as standard outputs**

Number of channels per module	8 configurable digital inputs/outputs	
Reference potential for all inputs	Terminals 1.9...4.9 (Minus pole of the supply voltage, signal name ZP)	
Common power supply voltage	For all outputs: terminals 1.8...4.8 (plus pole of the process supply voltage, signal name UP)	
Output voltage for signal 1	UP (-0.8 V)	
Input delay (0->1 or 1->0)	typically 10 µs	
Output current	Rated value, per channel	500 mA at UP = 24 V
	Maximum value (all channels together, PWM included)	8 A
	Leakage current with signal 0	< 0.5 mA
	Rated protection fuse on UP	10 A fast
Demagnetization when inductive loads are switched off	With varistors integrated in the module	
Switching frequency	With inductive loads	Max. 0.5 Hz
	With lamp loads	Max. 11 Hz with max. 5 W
Short circuit proof/overload proof	yes	
Overload message (I > 0.7 A)	Yes, after approx. 100 ms	
Output current limitation	Yes, automatic reactivation after short-circuit/overload	
Resistance to feedback against 24 V signals	Yes	
Max. cable length	shielded	1000 m (3280.83 ft)
	unshielded	600 m (1968.50 ft)

**Technical data for the high-speed inputs (A0, B0, Z0; A1, B1, Z1)**

Number of channels per module	6	
Reference potential for all inputs	Terminals 1.9, 2.9, 3.9 and 4.9 (Minus pole of the process voltage, signal name ZP)	
Input Type	24 V DC	5 V DC / Differential / Sinus 1 Vpp
Input current per channel	Input voltage +24 V	Typically 14 mA
	Input voltage +5 V	> 4.8 mA
	Input voltage +15 V	> 12 mA
	Input voltage +30 V	< 15 mA
Input type according to EN 61131-2	Type 1	
Input frequency (max.)	300 kHz	300 kHz
Input signal voltage	24 V DC	5 V DC
Signal 0	-3 V...+ 5 V	-3 V...+ 0.5 V
Undefined signal	> +5 V...< +15 V	--
Signal 1	+ 15 V...+30 V	+ 0.5 V...+30 V
Ripple with signal 0	Within -3 V...+5 V	Within -3 V...+0.5 V
Ripple with signal 1	Within +15 V...+30 V	Within +0.5 V...+30 V
Max. cable length	shielded	1000 m (3280.83 ft)
	unshielded	600 m (1968.50 ft)

Technical data of the fast outputs		
Number of channels per module	2	
Reference potential for all inputs	Terminals 1.9...4.9 (Minus pole of the process voltage, signal name ZP)	
Common power supply voltage	For all outputs: terminals 1.8...4.8 (plus pole of the process supply voltage, signal name UP)	
Indication of the output signals	Brightness of the LED depends on the number of pulses emitted (0% to 100%) – pulse output mode only	
Output delay (0->1 or 1->0)	Typically 1 $\mu$ s	
Output current	Rated value, per channel	100 mA at UP = 24 V
	Maximum value (all channels together, configurable outputs included)	8 A
	Leakage current with signal 0	< 0.5 mA
	Rated protection fuse on UP	10 A fast
De-magnetization when inductive loads are switched off	With varistors integrated in the module	
Switching frequency	PWM: upto 100 kHz (min. step for PWM value: 2 $\mu$ s) Pulse: upto 15 k Hz	
Short circuit proof/overload proof	yes	
Overload message ( $I > 0.7A$ )	Yes, after approx. 100 ms	
Output current limitation	Yes, automatic reactivation after short-circuit/overload	
Resistance to feedback against 24 V signals	Yes, with positive polarity only	
Max. cable length	shielded	1000 m (3280.83 ft)
	unshielded	600 m (1968.50 ft)

Technical data of the 5-V-sensor supply	
Number of supplies	2, independent configuration
Voltage supply (outputs unloaded)	5 V DC +/- 5%
Resistance to feedback against reverse polarity	No
Output current	100 mA max. (independently) 200 mA max. (parallel use)
Output diagnosis	Yes, with diagnosis LED and error message



## 5.2.4.2 Digital input/output module DC 722F

Name	Short Description	Article No.
DC 722F	Digital input/output module 16 DI/DO: 24 VDC/0.5 A 2-wire, 24 VDC 200 W TU 715F /TU 716F (terminal unit not included)  – Profibus remote I/O	3BDH000372R0001

It has 16 channels with the following features:

- Two 24 V DC 0.5 A sensor power supplies with short-circuit and overload protection
- 16 digital Inputs/Outputs 24 V DC in one groups (2.0...2.7 and 4.0...4.7), each of which can be used
  - as input,
  - as transistor output with short-circuit and overload protection with 0.5 A rated current or
  - as re-readable output (combined input/output) and can be addressed accordingly.



This I/O module can only be used as Profibus remote I/O and not as direct I/O.

The technical data correspond to the input and output values. The inputs and outputs are electrically isolated from the other electronic circuitry of the module. There is no potential separation between the channels.

### Technical data

Functionality DC 722F	
Digital Inputs/Outputs	24 digital Inputs/Outputs
Supply voltage	24 V DC
High-speed counter	Integrated, many configurable operating mode
Power supply	Internal: through the expansion bus interface (I/O-Bus) external: via the terminals ZP and UP (process voltage 24 V DC)
Potential separation	Module-wise
LEDs	For indicating signal statuses, errors and supply voltage
Process supply voltage UP	
Connections	Terminals 1.8 – 4.8 for +24 V (UP) and 1.9 – 4.9 for 0 V (ZP)
Rated value	24 V DC
max. ripple	5 %
Protection against reversed voltage	Yes
Rated protection fuse on UP	10 A fast
Electrical isolation	Yes, per module
Current consumption	
From 24 V DC power supply at the terminals UP/L+ and ZP/M of the CPU/ Bus Module	Approx. 1 mA
Current consumption via UP in case of normal operation	50 mA + max. 8 mA per input + max. 0.5 A per output

#### Technical data DC 722F

Inrush current from UP (at power-up)	0.008 A <sup>2</sup> s
Max. power dissipation within the module	6 W (outputs not loaded)
<b>Sensor power supply</b>	
Connections	Terminals 1.0...1.3 = +24 V, 1.4...1.7 = 0V Terminals 3.0...3.3 = +24 V, 3.4...3.7 = 0V
Voltage	24 V DC with short-circuit and overload protection
Loadability	Terminals 1.0...1.3, in total max. 0.5 A Terminals 3.0...3.3, in total max. 0.5 A
Dimensions	67.5 x 76 x 54 mm / 2.66 x 2.99 x 2.13 inch width x height x depth
Weight (without terminal unit)	Approx. 125 g / 4.41 oz.
Mounting position	Horizontal or vertical with limitations (Output load per group is 50 % at 40°C (104°F))
Cooling	The natural convection cooling must not be hindered by cable ducts or other parts in the mounting cabinet.

#### Technical data digital inputs/outputs

Number of channels per module	16
Distribution of the channels into groups	1 group of 16 channels
If the channels are used as inputs	
Connections to the channels C0 to C7	Terminals 2.0 to 2.7
Connections to the channels C8 to C15	Terminals 4.0 to 4.7
If the channels are used as outputs	
Connections to the channels C0 to C7	Terminals 2.0 to 2.7
Connections to the channels C8 to C15	Terminals 4.0 to 4.7
Indication of the input/output signals	One yellow LED per channel, the LED is ON when the input/output signal is high (signal 1)
Electrical isolation	From the rest of the module



### Technical data digital inputs/outputs if used as inputs

Each of the configurable I/O channels is defined as input or output by the user program. This is done through scanning or allocation of the corresponding channel.

Number of channels per module	16 inputs digital	
Reference potential for all inputs	Terminals 1.9...4.9 ( minus pole of the process supply voltage, signal name ZP)	
Electrical isolation	From the rest of the module	
Indication of the input signals	One yellow LED per channel, the LED is ON when the input/output signal is high (signal 1)	
Input type according to EN 61131-2	Type 1	
Input delay (0->1 or 1->0)	Typically 8 ms, configurable from 0.1 to 32 ms	
Input signal voltage	24 V DC	
Signal 0	-3 V...+5 VP*	
Undefined signal	> +5 V...< +15 V	
Signal 1	+15 V...+30 V	
Ripple with signal 0	Within -3 V...+5 V *	
Ripple with signal 1	Within +15 V...+30 V	
Input current per channel	Input voltage +24 V	typically 5 mA
	Input voltage +5 V	> 1 mA
	Input voltage +15 V	> 5 mA
	Input voltage +30 V	< 8 mA
Max. cable length	Shielded	1000 m (3280.83 ft)
	Unshielded	600 m (1968.50 ft)

\* Due to the direct connection to the output, the demagnetizing varistor is also effective at the input. This is why the difference between UPx and the input signal may not exceed the clamp voltage of the varistor. The varistor limits the voltage to approx. 36 V. Following this, the input voltage must range from -12 V to +30 V when UPx = 24 V and from -6 V to +30 V when UPx = 30 V.

### Technical data digital inputs/outputs if used as outputs

Number of channels per module	Max. 16 digital outputs	
Reference potential for all outputs	Terminals 1.9...4.9 (minus pole of the process supply voltage, signal name ZP)	
Common power supply voltage	For all outputs: terminals 1.8...4.8 (plus pole of the process supply voltage, signal name UP)	
Output voltage for signal 1	UP (-0.8 V)	
Output current	rated value, per channel	500 mA at UP = 24 V
	maximum value (all channels)	8 A
	Leakage current with signal 0	< 0.5 mA
	Rated protection fuse on UP	10 A fast
Demagnetization when inductive loads are switched off	Via varistors integrated in the module	
Switching frequency	With inductive loads	Max. 0.5 Hz
	With lamp loads	Max. 11 Hz with max. 5 W
Short-circuit proofed /overload proofed	Yes	
Overload message (I > 0,7 A)	Yes, after approx. 100 ms	
Output current limitation	Yes, automatic reactivation after short-circuit /overload	
Resistance to feedback against 24 V signals	Yes	
Max. cable length	Shielded	1000 m (3280.83 ft)
	Unshielded	600 m (1968.50 ft)



### 5.2.4.3 Digital input/output module DC 723F

Name	Short Description	Article No.
DC 723F	Digital input/output module 24 DI/DO: 24 VDC/0.5 A 1-wire, 24 VDC 300 W TU 715F /TU 716F (terminal unit not included)  – Profibus remote I/O	3BDH000373R0001

It has 24 channels with the following features:

- One 24 V DC 0.5 A sensor power supply with short-circuit and overload protection
- 24 digital Inputs/Outputs 24 V DC in three groups (2.0...4.7), each of which can be used
  - As an input,
  - As a transistor output with short-circuit and overload protection with 0.5 A rated current or
  - As a re-readable output (combined input/output) and can be addressed accordingly.



This I/O module can only be used as Profibus remote I/O and not as direct I/O.

The technical data correspond to the input and output values. The inputs and outputs are electrically isolated from the other electronic circuitry of the module. There is no potential separation between the channels.

### Technical data

Functionality DC 723F	
Digital Inputs/Outputs	24 digital Inputs/Outputs
Supply voltage	24 V DC
High-speed counter	Integrated, many configurable operating mode
Power supply	Internal: through the expansion bus interface (I/O-Bus) external: via the terminals ZP and UP (process voltage 24 V DC)
Potential separation	Module-wise
LEDs	For indicating signal statuses, errors and supply voltage

Technical data DC 723F	
Process supply voltage UP	
Connections	Terminals 1.8 – 4.8 for +24 V (UP) and 1.9 – 4.9 for 0 V (ZP)
Rated value	24 V DC
Max. ripple	5 %
Protection against reversed voltage	Yes
Rated protection fuse on UP	10 A fast
Electrical isolation	Yes, per module
Current consumption	
From 24 V DC power supply at the terminals UP/L+ and ZP/M of the CPU/Bus Module	Approx. 1 mA

### Technical data DC 723F

Current consumption via UP in case of normal operation	50 mA + max. 8 mA per input + max. 0.5 A per output
Inrush current from UP (at power-up)	0.008 A <sup>2</sup> s
Max. power dissipation within the module	6 W (outputs not loaded)
Sensor power supply	
Connections	Terminals 1.0...1.3 = +24 V, 1.4...1.7 = 0V
Voltage	24 V DC with short-circuit and overload protection
Loadability	Terminals 1.0...1.3, in total max. 0.5 A
Dimensions	67.5 x 76 x 54 mm / 2.66 x 2.99 x 2.13 inch width x height x depth
Weight (without terminal unit)	Approx. 125 g / 4.41 oz.
Mounting position	Horizontal or vertical with limitations (Output load per group is 50 % at 40°C (104°F))
Cooling	The natural convection cooling must not be hindered by cable ducts or other parts in the mounting cabinet.

### Technical data digital inputs/outputs

Number of channels per module	24
Distribution of the channels into groups if the channels are used as inputs	1 group of 24 channels
Connections to the channels C0 to C7	Terminals 2.0 to 2.7
Connections to the channels C8 to C15	Terminals 3.0 to 3.7
Connections to the channels C16 to C23	Terminals 4.0 to 4.7
If the channels are used as outputs	
Connections to the channels C0 to C7	Terminals 2.0 to 2.7
Connections to the channels C8 to C15	Terminals 3.0 to 3.7
Connections to the channels C16 to C23	Terminals 4.0 to 4.7
Indication of the input/output signals	One yellow LED per channel, the LED is ON when the input/output signal is high (signal 1)
Electrical isolation	From the rest of the module

### Technical data digital inputs/outputs if used as inputs

Each of the configurable I/O channels is defined as input or output by the user program. This is done through scanning or allocation of the corresponding channel.	
Number of channels per module	24 inputs digital
Reference potential for all inputs	Terminals 1.9...4.9 ( minus pole of the process supply voltage, signal name ZP)
Electrical isolation	From the rest of the module

**Technical data digital inputs/outputs if used as inputs**

Indication of the input signals	One yellow LED per channel, the LED is ON when the input/output signal is high (signal 1)	
Input type according to EN 61131-2	Type 1	
Input delay (0->1 or 1->0)	Typically 8 ms, configurable from 0.1 to 32 ms	
Input signal voltage	24 V DC	
Signal 0	-3 V...+5 VP*	
Undefined signal	+5 V...+15 V	
Signal 1	+15 V...+30 V	
Ripple with signal 0	Within -3 V...+5 V*	
Ripple with signal 1	Within +15 V...+30 V	
Input current per channel	Input voltage +24 V	typically 5 mA
	Input voltage +5 V	> 1 mA
	Input voltage +15 V	> 5 mA
	Input voltage +30 V	< 8 mA
Max. cable length	Shielded	1000 m (3280.83 ft)
	Unshielded	600 m (1968.50 ft)

\* Due to the direct connection to the output, the demagnetizing varistor is also effective at the input. This is why the difference between UPx and the input signal may not exceed the clamp voltage of the varistor. The varistor limits the voltage to approx. 36 V. Following this, the input voltage must range from -12 V to +30 V when UPx = 24 V and from -6 V to +30 V when UPx = 30 V.

**Technical data digital inputs/outputs if used as outputs**

Number of channels per module	Max. 24 digital outputs	
Reference potential for all outputs	Terminals 1.9...4.9 (minus pole of the process supply voltage, signal name ZP)	
Common power supply voltage	for all outputs: terminals 1.8...4.8 (plus pole of the process supply voltage, signal name UP)	
Output voltage for signal 1	UP (-0.8 V)	
Output current	Rated value, per channel	500 mA at UP = 24 V
	Maximum value (all channels)	8 A
	Leakage current with signal 0	< 0.5 mA
	Rated protection fuse on UP	10 A fast
Demagnetization when inductive loads are switched off	Via varistors integrated in the module	
Switching frequency	With inductive loads	Max. 0.5 Hz
	With lamp loads	Max. 11 Hz with max. 5 W
Short-circuit proofed /overload proofed	Yes	
Overload message (I > 0,7 A)	Yes, after approx. 100 ms	
Output current limitation	Yes, automatic reactivation after short-circuit /overload	
Resistance to feedback against 24 V signals	Yes	
Max. cable length	Shielded	1000 m (3280.83 ft)
	Unshielded	600 m (1968.50 ft)

## 5.2.4.4 Digital input / output module DC 732F



Name	Short Description	Article No.
DC 732F	Digital Input / Output Module  16 DI, 16 DI/DO, 24 VDC / 0.5 A, 1-Wire, 24 VDC 200 W. Without terminal unit.  - Profibus remote I/O - Direct I/O for AC 700F and AC 900F	3BDH000375R0001

The DC 732F module offers 32 channels. 16 channels are assigned as digital inputs, while the remaining 16 channels can be configured as input or as output.

### Technical data

Functionality DC 732F	
Digital inputs	16 (24 VDC)
Digital inputs / outputs (configurable)	16 (24 VDC)
LED displays	For signal statuses, errors and supply voltage
External power supply	Via the terminals ZP and UP (process voltage 24 VDC) of the modules terminal unit TU 715F

Technical data DC 732F	
Process supply voltage UP	
Connections	Terminals 1.8 - 4.8 for +24 V (UP) and 1.9 - 4.9 for 0 V (ZP)
Rated value	24 VDC
Max. ripple	5%
Protection against reversed voltage	Yes
Rated protection fuse on UP	10 A fast
Electrical isolation	Yes, per module
Current consumption	
Internal (via I/O-Bus)	ca. 5 mA at 3.3 VDC
Current consumption from UP at normal operation/ with outputs	50 mA + max. 8 mA per input + max. 0.5 A per output
Inrush current from UP (at power up)	0.007 A <sup>2</sup> s
Max. power dissipation within the module	6 W (outputs unloaded)
Dimensions (width x height x depth - without Terminal Unit)	67.5 x 76 x 54 mm / 2.66 x 2.99 x 2.13 inch
Weight (without Terminal Unit)	Approx. 125 g / 4.41 Oz.
Cooling	The natural convection cooling must not be hindered by cable ducts or other parts in the mounting cabinet.

Technical data of the digital inputs DC 732F		
Number of channels per module	16	
Distribution of the channels into groups	1 group of 16 channels	
Terminals of the channels I0 to I7	1.0 to 1.7	
Terminals of the channels I8 to I15	2.0 to 2.7	
Reference potential for all inputs	Terminals 1.9...4.9 (minus pole of the process supply voltage, signal name ZP)	
Electrical isolation	From the rest of the module (I/O-Bus)	
Indication of the input signals	One yellow LED per channel, the LED is ON when the input signal is high (signal 1)	
Input type acc. to EN 61131-2	Type 1	
Input delay (0->1 or 1->0)	Typ. 8 ms, configurable from 0.1 to 32 ms	
Input signal voltage	24 VDC	
Signal 0	-3 V...+5 V	
Undefined signal	> +5 V...< +15 V	
Signal 1	+15 V...+30 V	
Ripple with signal 0	Within -3 V...+5 V	
Ripple with signal 1	Within +15 V...+30 V	
Input current per channel		
Input voltage +24 V	Typ. 5 mA	
Input voltage +5 V	> 1 mA	
Input voltage +15 V	> 5 mA	
Input voltage +30 V	< 8 mA	
Max. cable length	Shielded	1000 m / 3280 ft.
	Unshielded	600 m / 1968 ft.

Technical data of the configurable digital inputs / outputs DC 732F		
Each of the configurable I/O channels can be wired as input or output by the user.		
Number of channels per module	16 inputs / outputs (with transistors)	
Distribution of the channels into groups	1 group of 16 channels	
If the channels are used as inputs		
Channels I16...I23	Terminals 3.0...3.7	
Channels I24...I31	Terminals 4.0...4.7	
If the channels are used as outputs		
Channels O16...O23	Terminals 3.0...3.7	
Channels O24...O31	Terminals 4.0...4.7	
Indication of the input / output signals	One yellow LED per channel, the LED is ON when the input / output signal is high (signal 1)	
Electrical isolation	From the rest of the module	

### Technical data of the digital inputs / outputs if used as outputs DC 732F

Number of channels per module	Max. 16 transistor outputs	
Reference potential for all outputs	Terminals 1.9...4.9 (minus pole of the process supply voltage, signal name ZP)	
Common power supply voltage	For all outputs: terminals 1.8...4.8 (plus pole of the process supply voltage, signal name UP)	
Output voltage for signal 1	UP -0.8 V	
Output current		
Rated value, per channel	500 mA at UP = 24 V	
Maximum value (all channels together)	8 A	
Leakage current with signal 0	< 0.5 mA	
Rated protection fuse on UP	10 A fast	
De-magnetization when inductive loads are switched off	With varistors integrated in the module	
Short-circuit proof / overload proof	Yes	
Overload message (I > 0.7 A)	Yes, after ca. 100 ms	
Output current limitation	Yes, automatic reactivation after short-circuit / overload	
Resistance to feedback against 24 V signals	Yes	
Max. cable length	Shielded	1000 m / 3280 ft.
	Unshielded	600 m / 1968 ft.

### Technical data of the digital inputs / outputs if used as inputs DC 732F

Number of channels per module	Max. 16 digital inputs	
Reference potential for all inputs	Terminals 1.9...4.9 (minus pole of the process supply voltage, signal name ZP)	
Input type acc. to EN 61131-2	Type 1	
Input delay (0->1 or 1->0)	Typ. 8 ms, configurable from 0.1 to 32 ms	
Input signal voltage	24 VDC	
Signal 0	-3 V...+5 V *	
Undefined signal	> +5 V...< +15 V	
Signal 1	+15 V...+30 V	
Ripple with signal 0	within -3 V...+5 V *	
Ripple with signal 1	within +15 V...+30 V	
Max. cable length	Shielded	1000 m / 3280 ft.
	Unshielded	600 m / 1968 ft.

\* Due to the direct connection to the output, the demagnetizing varistor is also effective at the input. This is why the difference between UPx and the input signal may not exceed the clamp voltage of the varistor. The varistor limits the voltage to approx. 36 V. Following this, the input voltage must range from - 12 V to + 30 V when UPx = 24 V and from - 6 V to + 30 V when UPx = 30 V.

The configurable channels are defined by the wiring. As you can see from Figure 6, some of the first 16 input channels show the corresponding wiring. For the next 16 configurable channels you see some examples for inputs (channel 16, 23, 24, and 31) and some examples for outputs (channel 19 and 27). Note that the power has to be supplied depending on the planned power consumption as indicated. The I/O bus supplies the power for the modules electronics only.

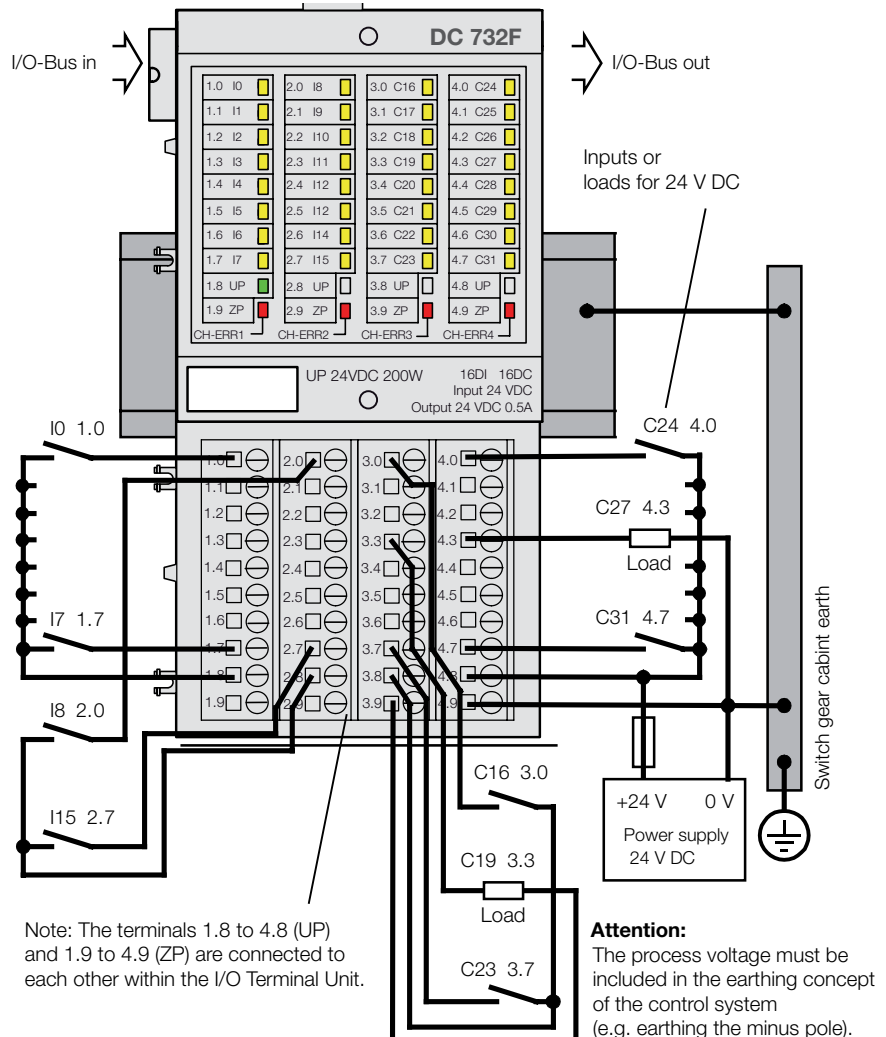

Figure 6: Wiring of DC 732F



## 5.2.4.5 Digital input module DI 724F



Name	Short Description	Article No.
DI 724F	<p>Digital input module</p> <p>32 DI: 24 VDC 1-wire, 24 VDC 1 W TU 715F /TU 716F (terminal unit not included)</p> <p>– Profibus remote I/O – Direct I/O for AC 700F and AC 900F</p>	3BDH000374R0001

It has 32 channels with the following features:

- 32 digital inputs 24V DC in four groups (1.0...4.7)

The technical data correspond to the input values. The inputs are electrically isolated from the other electronic circuitry of the module. There is no potential separation between the channels.

### Technical data

Functionality DI 724F	
Digital Inputs	32 digital inputs
Supply voltage	24 V DC
High-speed counter	Integrated, many configurable operating mode
Power supply	Internal: through the expansion bus interface (I/O-Bus) external: via the terminals ZP and UP (process voltage 24 V DC)
Potential separation	Module-wise
LEDs	For indicating signal statuses, errors and supply voltage

Technical data DI 724F	
Process supply voltage UP	
Connections	Terminals 1.8 – 4.8 for +24 V (UP) and 1.9 – 4.9 for 0 V (ZP)
Rated value	24 V DC
max. ripple	5 %
Protection against reversed voltage	Yes
Rated protection fuse on UP	10 A fast
Electrical isolation	Yes, per module
Current consumption	
From 24 V DC power supply at the terminals UP/L+ and ZP/M of the CPU/Bus Module	approx. 1 mA
Current consumption via UP in case of normal operation	50 mA + max. 8 mA per input
Inrush current from UP (at power-up)	0.008 A <sup>2</sup> s

Technical data DI 724F	
Dimensions (Width x height x depth)	67.5 x 76 x 54 mm / 2.66 x 2.99 x 2.13 inch
Weight (without Terminal Unit)	Approx. 105 g / 3.7 oz.
Mounting position	Horizontal or vertical with limitations (output load per group is 50 % at 40°C (104°F))
Cooling	The natural convection cooling must not be hindered by cable ducts or other parts in the mounting cabinet.

Technical data digital inputs	
Number of channels per module	32
Distribution of the channels into groups	1 group of 32 channels
Connections to the channels I0 to I7	Terminals 1.0 to 1.7
Connections to the channels I8 to I15	Terminals 2.0 to 2.7
Connections to the channels I16 to I23	Terminals 3.0 to 3.7
Connections to the channels I24 to I31	Terminals 4.0 to 4.7
Reference potential for all inputs	Terminal 1.9...4.9 (minus pole of the process supply voltage, signal name ZP)
Electrical isolation	From the rest of the module
Indication of the input signals	One yellow LED per channel, the LED is ON when the input signal is high (signal 1)
Input type acc. to EN 61131-2	Type 1
Input delay (0->1 or 1->0)	Typically 8 ms, configurable from 0.1 to 32 ms
Input signal voltage	24 V DC
Signal 0	-3 V...+5 V
Undefined signal	> +5 V...< +15 V
Signal 1	+15 V...+30 V
Ripple with signal 0	Within -3 V...+5 V
Ripple with signal 1	Within +15 V...+30 V
Input current per channel	
Input voltage +24 V	typically 5 mA
Input voltage +5 V	> 1 mA
Input voltage +15 V	> 5 mA
Input voltage +30 V	< 8 mA
Max. cable length	Shielded 1000 m (3280.83 ft) Unshielded 600 m (1968.50 ft)

## 5.2.4.6 Digital input / output module DX 722F



Name	Short description	Article No.
DX 722F	Digital input / output module 8 DI: 24 VDC 8 DO: relay contacts, 24 VDC, 230 VAC 1/3-wire, 24 VDC 2 W TU 731F /TU 732F (terminal unit not included)  – Profibus remote I/O – Direct I/O for AC 700F and AC 900F	3BDH000383R0001

It has 16 channels with the following features:

- 8 digital inputs 24 V DC in one group (1.0...1.7)
- as well as 8 relay outputs (2.0...2.7), with one switch-over contact each

The technical data correspond to the input and output values. The inputs and outputs are electrically isolated from the other electronic circuitry of the module. There is no potential separation between the input channels.

### Technical data

#### Functionality DX 722F

Inputs/outputs	8 digital inputs 8 relay outputs with one switch-over contact each
Relay contact supply voltage	24 V DC
Power supply	internal: through the expansion bus interface (I/O Bus) external: via the terminals ZP and UP (process voltage 24 V DC)
Potential separation	module-wise
LEDs	for indicating signal statuses, errors and supply voltage

#### Technical data DX 722F

Process supply voltage UP	
Connections	Terminals 1.8 – 4.8 for +24 V (UP) and 1.9 – 4.9 for 0 V (ZP)
Rated value	24 V DC
Max. ripple	5 %
Protection against reversed voltage	Yes
Rated protection fuse on UP	10 A fast
Electrical isolation	Yes, per module
Current consumption	
internal (via I/O-Bus)	approx. 1 mA at 24 V DCs
current consumption via UP in case of normal operation	0.05 A + output loads)
inrush current from UP (at power-up)	0.010 A <sup>2</sup> s
Max. power dissipation within the module	6 W (outputs not loaded)
Dimensions (width x height x depth)	67.5 x 76 x 54 mm / 2.66 x 2.99 x 2.13 inch
Weight (without terminal unit)	approx. 300 g/10.58 oz.
Mounting position	Horizontal or vertical with limitations (output load per group 50 % at 40°C (104°F))
Cooling	The natural convection cooling must not be hindered by cable ducts or other parts in the mounting cabinet.

Technical data digital inputs DX 722F		
Number of channels per module	8	
Distribution of the channels into groups	1 group of 8 channels	
Connections to the channels I0 to I7	Terminals 1.0 to 1.7	
Reference potential for all inputs	Terminal 1.9...4.9 (minus pole of the process supply voltage, signal name ZP)	
Electrical isolation	From the rest of the module	
Indication of the input signals	One yellow LED per channel, the LED is ON when the input signal is high (signal 1)	
Input type according to EN 61131-2	Type 1	
Input delay (0->1 or 1->0)	Typically 8 ms	
Input signal voltage	24 V DC	
Signal 0	-3 V...+5 V	
Undefined signal	+5 V... +15 V	
Signal 1	+15 V...+30 V	
Ripple with signal 0	Within -3 V...+5 V	
Ripple with signal 1	Within +15 V...+30 V	
Input current per channel		
Input voltage +24 V	Typically 5 mA	
Input voltage +5 V	> 1 mA	
Input voltage +15 V	> 5 mA	
Input voltage +30 V	< 8 mA	
Maximal cable length	Shielded	1000 m (3280.83 ft)
	Unshielded	600 m (1968.50 ft)

### Technical data relay outputs DX 722F

Number of channels per module	8 relay outputs	
Distribution of the channels into groups	8 groups of 1 channel each	
Connection of the channel R0	Terminal 2.0 (common), 3.0 (NO) and 4.0 (NC)	
Connection of the channel R1	Terminal 2.1 (common), 3.1 (NO) and 4.1 (NC)	
Connection of the channel R6	Terminal 2.6 (common), 3.6 (NO) and 4.6 (NC)	
Connection of the channel R7	Terminal 2.7 (common), 3.7 (NO) and 4.7 (NC)	
Electrical isolation	Between the channels and from the rest of the module	
Indication of the output signals	One yellow LED per channel, the LED is ON when the relay coil is energized	
Relay power supply	By UP process voltage	
Relay outputs		
Output short-circuit protection	Should be provided externally with a fuse or circuit breaker	
Rated protection fuse	6A gL/gG per channel	
Output switching capacity		
Resistive load max.	3 A; 3A (120/230V AC), 2A (24 V DC)	
Inductive load max.	1.5 A; 1.5A (120/230V AC), 1.5 A (24 V DC)	
Lamp load	60 W (230V AC), 10 W (24 V DC)	
Life times (cycles)	Mechanical: 300 000; under load: 300 000 (24 V DC at 2 A), 200 000 (120 V AC at 2 A), 100 000 (230 V AC at 3 A)	
Spark suppression with inductive AC load	Must be performed externally according to driven load specifications	
Demagnetization with inductive DC load	A free-wheeling diode must be circuited in parallel to the inductive load	
Switching frequency		
With resistive load	Max. 10 Hz	
With inductive load	Max. 2 Hz	
Maximal cable length	Shielded	1000 m (3280.83 ft)
	Unshielded	600 m (1968.50 ft)

5



### Digital input / output module DX 731F

Name	Short description	Article No.
DX 731F	Digital input / output module 8 DI: 120/230 VAC 4 DO: relay contacts, 24 VDC, 120/230 VAC 2-wire, 24 VDC 2 W TU 731F /TU 732F (terminal unit not included)  – Profibus remote I/O – Direct I/O for AC 700F and AC 900F	3BDH000387R0001

It has 12 channels with the following features:

- 8 digital inputs 230 V DC in two groups (2.0...3.3)
- as well as 4 relay outputs (2.4...2.7), with one switch-over contact each

The technical data correspond to the input and output values. The inputs and outputs are electrically isolated from the other electronic circuitry of the module.

## Technical data

### Functionality DX 731F

Inputs/outputs	8 digital inputs 4 relay outputs with one switch-over contact each
Supply voltage	230 V AC
Power supply	internal: through the expansion bus interface (I/O Bus) external: via the terminals ZP and UP (process voltage 24 V DC)
Potential separation	module-wise
LEDs	for indicating signal statuses, errors and supply voltage

### Technical data DX 731F

Process supply voltage UP	
Connections	Terminals 1.8 – 4.8 for +24 V (UP) and 1.9 – 4.9 for 0 V (ZP)
Rated value	24 V DC
Max. ripple	5 %
Protection against reversed voltage	Yes
Rated protection fuse on UP	10 A fast
Electrical isolation	Yes, per module
Current consumption	
internal (via I/O-Bus)	approx. 1 mA
current consumption via UP in case of normal operation	0.05 A + output loads)
inrush current from UP (at power-up)	0.004 A <sup>2</sup> s
Max. power dissipation within the module	6 W (outputs not loaded)
Dimensions (width x height x depth)	67.5 x 76 x 54 mm / 2.66 x 2.99 x 2.13 inch
Weight (without terminal unit)	approx. 300 g/10.58 oz.
Mounting position	Horizontal or vertical with limitations (output load per group 50 % at 40°C (104°F))
Cooling	The natural convection cooling must not be hindered by cable ducts or other parts in the mounting cabinet.

### Technical data digital inputs DX 731F

Number of channels per module	8
Distribution of the channels into groups	4 group of 2 channels
Terminals of the channels I0 to I7	Terminals 2.0 to 2.3, 3.0 to 3.3, 4.0 to 4.3
Electrical isolation	From the rest of the module
Indication of the input signals	One yellow LED per channel, the LED is ON when the input signal is high (signal 1)
Input type acc. to EN 61131-2	Type 2
Input delay (0->1 or 1->0)	Typically 20 ms
Input signal voltage	230 V AC or 120V AC

### Technical data digital inputs DX 731F

Signal 0	0 V...40 V AC	
Undefined signal	> 40 V AC...< 74 V AC	
Signal 1	74 V...265 V AC	
Input current per channel		
Input voltage 159 V AC	> 7 mA	
Input voltage 40 V AC	< 5 mA	
Max. cable length	Shielded	1000 m (3280.83 ft)
	Unshielded	600 m (1968.50 ft)

### Technical data relay outputs DX 731F

Number of channels per module	4 relay outputs	
Distribution of the channels into groups	4 groups of 1 channel each	
Connection of the channel R0	Terminal 2.4 (common), 3.4 (NO) and 4.4 (NC)	
Connection of the channel R1	Terminal 2.5 (common), 3.5 (NO) and 4.5 (NC)	
Connection of the channel R2	Terminal 2.6 (common), 3.6 (NO) and 4.6 (NC)	
Connection of the channel R3	Terminal 2.7 (common), 3.7 (NO) and 4.7 (NC)	
Electrical isolation	Between the channels and from the rest of the module	
Indication of the output signals	one yellow LED per channel, the LED is ON when the relay coil is energized	
Relay power supply	By UP process voltage	
Relay outputs		
output short-circuit protection	Should be provided externally with a fuse or circuit breaker	
rated protection fuse	6A gL/gG per channel	
Output switching capacity		
resistive load max.	3 A; 3A (230V AC), 2A (24 V DC)	
inductive load max.	1.5 A; 1.5A (230V AC), 1.5 A (24 V DC)	
lamp load	60 W (230V AC), 10 W (24 V DC)	
Life times (cycles)	mechanical: 300 000;	
	under load: 300 000 (24 V DC at 2 A), 200 000 (120 V AC at 2 A), 100 000 (230 V AC at 3 A)	
Spark suppression with inductive AC load	must be performed externally according to driven load specifications	
Demagnetization with inductive DC load	a free-wheeling diode must be circuited in parallel to the inductive load	
Switching frequency	with resistive load	max. 10 Hz
	with inductive load	max. 2 Hz
Max. cable length	shielded	1000 m (3280.83 ft)
	unshielded	600 m (1968.50 ft)



## 5.2.5 Analog I/O Modules

### 5.2.5.1 Analog input/output module AC 722F

Name	Short Description	Article No.
AC 722F	Analog input/output module 8 AI/AO: +-10 V, 0/4-20 mA, RTD 12 Bit + sign, 2-wire, 24 VDC 5 W TU 715F /TU 716F (terminal unit not included)  – Profibus remote I/O	3BDH000369R0001

It has 8 channels with the following features:

- 8 analog inputs/outputs in one group (2.0...2.7 and 3.0...3.7), of which each can be used
  - as an input or
  - as an output



This I/O module cannot be used as direct I/O for AC 700F or AC 900F.

The technical data correspond to the input and output values. The inputs and outputs are electrically isolated from the other electronic circuitry of the module. There is no potential separation between the channels.

## Technical data

Functionality AC 722F	
8 channels, when used as individually configurable analog inputs	unused (default setting)
	0...10 V
	-10 V...+10 V
	0...20 mA
	4...20 mA
	Pt100, -50 °C (-58 °F)...+400 °C (+752 °F) (2-wire)
	Pt100, -50 °C (-58 °F)...+400 °C (+752 °F) (3-wire), requires 2 channels
	Pt100, -50 °C (-58 °F)...+70 °C (+158°F) (2-wire)
	Pt100, -50 °C (-58 °F)...+70 °C (+158°F) (3-wire), requires 2 channels
	Pt1000, -50 °C (-58 °F)...+400 °C (+752 °F) (2-wire)
	Pt1000, -50 °C (-58 °F)...+400 °C (+752 °F) (3-wire), requires 2 channels
	Ni1000, -50 °C (-58 °F)...+150 °C (+302 °F) (2-wire)
	Ni1000, -50 °C (-58 °F)...+150 °C (+302 °F) (3-wire), requires 2 channels
	0...10 V with differential inputs, requires 2 channels
-10 V...+10 V with differential inputs, requires 2 channels	
digital signals (digital input)	



### Functionality AC 722F

4 channels, when used as individually configurable analog outputs	unused (default setting) -10 V...+10 V 0...20 mA 4...20 mA
4 channels, when used as individually configurable analog outputs	Unused (default setting) -10 V...+10 V
Resolution of the analog channels	Voltage -10 V... +10 V: 12 bits plus sign Voltage 0...10 V: 12 bits Current 0...20 mA, 4...20 mA: 12 bits Temperature: 0.1 °C/0.18 °F
Power supply	Internal: through the expansion bus interface (I/O Bus) external: via the terminals (process voltage 24 V DC)
Potential separation	Module-wise
LEDs	10 LEDs for signals and error messages

### Technical data AC 722F

Process voltage	
Rated value	24 V DC
Max. ripple	5 %
Protection against reversed voltage	Yes
Rated protection fuse on UP	10 A fast
Electrical isolation	Yes, per module
Current consumption from UP at normal operation	0.10 A + output load
Inrush current from UP (at power up)	0.040 A <sup>2</sup> s
Connections	Terminals 1.8 – 4.8 for +24 V (UP) and 1.9 - 4.9 for 0 V (ZP)
Max. length of analog cables, conductor cross section > 0.14 mm <sup>2</sup> (~26 AWG)	100 m (328.08 ft)
Conversion error of the analog values caused by non-linearity, adjustment error at factory and resolution within the normal range	Typically 0.5 %, max. 1 %
Dimensions (without the Terminal Unit)	67.5 x 76 x 54 mm / 2.66 x 2.99 x 2.13 inch width x height x depth
Weight	300 g/10.58 oz.
Mounting position	Horizontal or vertical with limitations (output load per group 50 % at 40°C (104°F))
Cooling	The natural convection cooling must not be hindered by cable ducts or other parts in the mounting cabinet

### Technical data analog inputs AC 722F

Number of channels per module	8
Distribution of channels into groups	1 group of 8 channels
Connections to channels C0- to C7-	Terminals 2.0 to 2.7
Connections to channels C0+ to C7+	Terminals 3.0 to 3.7
Type of Inputs	Bipolar (not in the case of current or Pt100/Pt1000/ Ni1000)
Electrical isolation	Against internal supply and other modules
Configurability	0...10 V, -10...+10 V, 0/4...20 mA, Pt100/1000, Ni1000 (each input can be configured individually)
Channel input resistance	Voltage: > 100 k $\Omega$ , current: approx. 330 $\Omega$
Time constant of the input filter	Voltage: 100 $\mu$ s, current: 100 $\mu$ s
Indication of the input signals	One LED per channel
Conversion cycle	2 ms (for 8 inputs + 8 outputs), with Pt/Ni...1 s
Resolution	Range 0...10 V: 12 bits Range -10...+10 V: 12 bits + sign Range 0...20 mA: 12 bits Range 4...20 mA: 12 bits
Unused voltage inputs	Are configurable as "unused"
Surge protection	Yes

### Technical data analog inputs AC 722F if they are used as digital inputs

Number of channels per module	max. 8
Distribution of channels into groups	1 group of 8 channels
Connections to channels C0+ to C7+	Terminals 3.0 to 3.7
Reference potential for the inputs	Terminals 1.8 to 4.8 (ZP)
Input signal delay	Typically 8 ms, configurable from 0.1 to 32 ms
Indication of the input signals	One LED per channel
Input signal voltage	24 V DC
Signal 0	-30 V...+5 V
Undefined signal	+5 V...+13 V
Signal 1	+13 V...+30 V
Input current per channel	
Input voltage +24 V	Typically 7 mA
Input voltage +5 V	Typically 1.4 mA
Input voltage +15 V	Typically 4.3 mA
Input voltage +30 V	< 9 mA
Input resistance	Approx. 3.5 k $\Omega$

### Technical data for analog outputs AC 722F

Number of channels per module	8, all channels for voltage, the first 4 are also for current
Distribution of channels into groups	1 group of 8 channels
Channels C0-...C7-	Terminals 2.0...2.7
Channels C0+...C7+	Terminals 3.0...3.7
Output type	Bipolar with voltage, unipolar with current
Electrical isolation	Against internal supply and other modules
Configurability	-10...+10 V, 0...20 mA, 4...20 mA (each output can be configured individually), current output in channels 0...3 only
Output resistance (load), as current output	0...500 Ohm
Output load capacity, as voltage output	Max. ±10 mA
Indication of the output signals	One LED per channel
Resolution	12 bits (+ sign)
Unused outputs	Can be left open circuited

5

### 5.2.5.2 Analog input module AI 723F



Name	Short Description	Article No.
AI 723F	<p>Analog input module</p> <p>16 AI: +10 V, 0/4-20 mA 24 VDC, Pt100 12 bit + Sign, 2-wire, 24 VDC 5 W.</p> <p>Without terminal unit.</p> <ul style="list-style-type: none"> <li>- Profibus remote I/O</li> <li>- Direct I/O for AC 700F and AC 900F</li> </ul>	3BDH000376R0001

The AI 723F module comes with 16 input channels. Each of these channels can be individually configured depending on its intended usage.

#### Possible applications are:

- Sensing a voltage (0...10 V or -10...+10 V)
- Sensing a current (0...20 mA or 4...20 mA)
- Temperature measurement (platinum or nickel resistance thermometers Pt100, Pt1000, Ni1000)
- For 3-wired connections two channels are required

## Technical data

### Functionality AI 723F

Inputs	16 analog inputs, individually configurable for Unused (default setting)
	0...10 V
	-10 V...+10 V
	0...20 mA
	4...20 mA
	Pt100, -50 °C (-58 °F)...+400 °C (+752 °F) 2-wire or 3-wire, requires 2 channels
	Pt100, -50 °C (-58 °F)...+70 °C (+158 °F) 2-wire or 3-wire, requires 2 channels
	Pt1000, -50 °C (-58 °F)...+400 °C (+752 °F) 2-wire or 3-wire, requires 2 channels
	Ni1000, -50 °C (-58 °F)...+150 °C (+302 °F) 2-wire or 3-wire, requires 2 channels
	0...10 V with differential inputs, requires 2 channels
	-10 V...+10 V with differential inputs, requires 2 channels
	Digital signals (digital input)

### Technical data AI 723F

LED displays	19 LEDs for signals and error indication
Internal power supply	Through the expansion bus interface (I/O-Bus)
External power supply	Via the terminals ZP and UP (process voltage 24 VDC) of TU 715F
Process voltage	
Rated value	24 VDC
Max. ripple	5%
Protection against reversed voltage	Yes
Rated protection fuse on UP	10 A fast
Electrical isolation	Per module
Current consumption from UP at normal operation	0.15 A
Inrush current from UP (at power up)	0.050 A <sup>2</sup> s
Connections	Terminals 1.8 - 4.8 for +24 V (UP) and 1.9 - 4.9 for 0 V (ZP)
Max. length of analog cables, conductor cross section > 0.14 mm <sup>2</sup> (~26 AWG)	100 m / 328 ft.

### Technical data AI 723F

Conversion error of the analog values caused by nonlinearity, adjustment error at factory and resolution within the normal range	Typ. 0.5 %, max. 1 %
Width x height x depth (without the Terminal Unit)	67.5 x 76 x 54 mm / 2.66 x 2.99 x 2.13 inch
Weight	300 g / 10.52 oz
Cooling	The natural convection cooling must not be hindered by cable ducts or other parts in the mounting cabinet.

### Technical data of the analog inputs AI 723F

Number of channels per module	16
Distribution of channels into groups	2 groups of 8 channels each
Connections of the channels I0- to I7-	Terminals 1.0 to 1.7
Connections of the channels I0+ to I7+	Terminals 2.0 to 2.7
Connections of the channels I8- to I15-	Terminals 3.0 to 3.7
Connections of the channels I8+ to I15+	Terminals 4.0 to 4.7
Electrical isolation	Against internal supply and other modules
Configuration	0...10 V, -10...+10 V, 0/4...20 mA, Pt100/1000, Ni1000 (each channel can be configured individually)
Channel input resistance	Voltage: > 100 kOhm, current: ca. 330 Ohm
Time constant of the input filter	Voltage: 100 µs, current: 100 µs
Indication of the input signals	One LED per channel
Resolution	Range 0...10 V: 12 bits Range -10...+10 V: 12 bits + sign Range 0...20 mA: 12 bits Range 4...20 mA: 12 bits Temperature: 0.1 °C / 0.18 °F
Overvoltage protection	Yes

### Technical data of the analog inputs, if they are used as digital inputs AI 723F

Number of channels per module	Max. 16
Distribution of channels into groups	2 groups of 8 channels each
Connections of the channels I0+ to I7+	Terminals 2.0 to 2.7
Connections of the channels I8+ to I15+	Terminals 4.0 to 4.7
Reference potential for the inputs	Terminals 1.8 to 4.8 (ZP)
Input signal delay	Typ. 8 ms
Indication of the input signals	One LED per channel
Input signal voltage	24 VDC
Signal 0	-30 V...+5 V
Signal 1	+13 V...+30 V

Two examples of wiring are shown with the following figures. Figure 7 shows wiring for a current input for 4...20 mA while Figure 8 shows a voltage sensor with differential inputs. Note that the latter one needs two adjacent channels, starting with an even channel number.

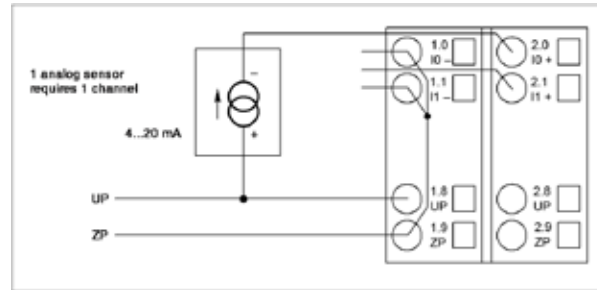

Figure 7: Connection of passive-type analog sensors (current)

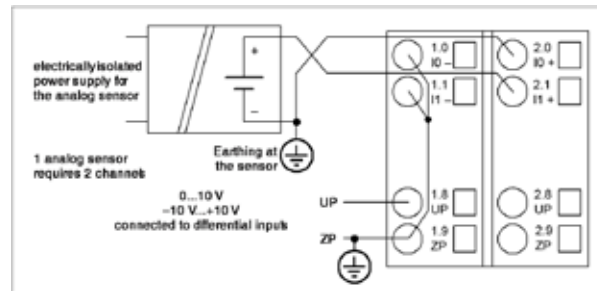

Figure 8: Connection of active-type analog sensors (voltage) to differential inputs

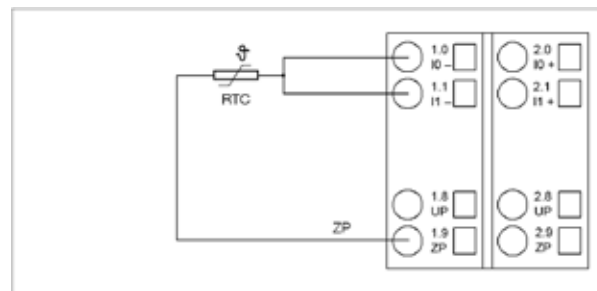

Figure 9: 3 wire RTC

### 5.2.5.3 Analog input module AI 731F (Thermocouple)



Name	Short Description	Article No.
AI 731F	Analog input module 8 AI: TC, RTD, mV/V, mA, kOhm and 24 VDC 15 Bit + sign, 2-, 3- and 4-wire, 24 VDC 5 W TU 715F /TU 716F (terminal unit not included)  – Profibus Remote I/O – Direct I/O for AC 700F and AC 900F	3BDH000385R0001

It has 8 channels with the following features:

- 8 configurable analog inputs in two groups (1.0...2.7 and 2.0...2.7 as well as 3.0...3.7 and 4.0...4.7)

## Technical data

### Functionality AI 731F

Input	<p>8 analog inputs, individually configurable for: unused (default setting)</p> <p>0...5V, 0...10 V</p> <p>-50...+50 mV, -500...+500 mV</p> <p>-1...+1 V, -5...+5 V, -10 V...+10 V</p> <p>0...20 mA</p> <p>4...20 mA</p> <p>-20...+20 mA</p> <p>Pt100, -50 °C (-58 °F)...+70 °C (+158°F) (2-wire)</p> <p>Pt100, -50 °C (-58 °F)...+70 °C (+158°F) (3-wire)</p> <p>Pt100, -50 °C (-58 °F)...+70 °C (+158°F) (4-wire)</p> <p>Pt100, -50 °C (-58 °F)...+70 °C (+158°F) (2-wire), resolution 0.01 K</p> <p>Pt100, -50 °C (-58 °F)...+70 °C (+158°F) (3-wire), resolution 0.01 K</p> <p>Pt100, -50 °C (-58 °F)...+70 °C (+158°F) (4-wire), resolution 0.01 K</p> <p>Pt100, -50 °C (-58 °F)...+400 °C (+752 °F) (2-wire)</p> <p>Pt100, -50 °C (-58 °F)...+400 °C (+752 °F) (3-wire)</p> <p>Pt100, -50 °C (-58 °F)...+400 °C (+752 °F) (4-wire)</p> <p>Pt100, -200 °C (-328°F)...+850 °C (+1562°F) (2-wire)</p> <p>Pt100, -200 °C (-328°F)... +850 °C (+1562°F) (3-wire)</p> <p>Pt100, -200 °C (-328°F)... +850 °C (+1562°F) (4-wire)</p> <p>Pt1000, -50 °C (-58 °F)...+400 °C (+752 °F) (2-wire)</p> <p>Pt1000, -50 °C (-58 °F)...+400 °C (+752 °F) (3-wire)</p> <p>Pt1000, -50 °C (-58 °F)...+400 °C (+752 °F) (4-wire)</p> <p>Ni1000, -50 °C (-58 °F)...+150 °C (+302 °F) (2-wire)</p> <p>Ni1000, -50 °C (-58 °F)...+150 °C (+302 °F) (3-wire)</p> <p>Ni1000, -50 °C (-58 °F)...+150 °C (+302 °F) (4-wire)</p> <p>Cu50 1.426, -50 °C (-58 °F)...+200 °C (+392°F) (2-wire)</p> <p>Cu50 1.426, -50 °C (-58 °F)...+200 °C (+392°F) (3-wire)</p> <p>Cu50 1.426, -50 °C (-58 °F)...+200 °C (+392°F) (4-wire)</p> <p>Cu50 1.428, -200 °C (-328°F)...+200 °C (+392°F) (2-wire)</p> <p>Cu50 1.428, -200 °C (-328°F)...+200 °C (+392°F) (3-wire)</p> <p>Cu50 1.428, -200 °C (-328°F)...+200 °C (+392°F) (4-wire)</p> <p>0...50 kOhm</p> <p>Thermocouples of types J, K, T, N, S</p> <p>digital signals (digital input)</p>
Resolution of the analog channels	<p>Voltage -1...+1V, -5...+5V, -10 V... +10 V: 15 bits plus sign</p> <p>Voltage 0...5 V, 0...10 V: 15 bits</p> <p>Current 0...20 mA, 4...20 mA, -20...+20 mA: 15 bits</p> <p>Temperature: 0.1 °C (0.18 °F), 0.01°C at Pt100 -50°C...+70°C</p>

Functionality AI 731F	
Power supply	internal: through the expansion bus interface (I/O Bus) external: via the terminals (process voltage 24 V DC)
Potential separation	module-wise
LEDs	11 LEDs for signals and error messages

Technical data AI 731F	
Process voltage	
Rated value	24 V DC
Max. ripple	5 %
Protection against reversed voltage	Yes
Rated protection fuse on UP	10 A fast
Electrical isolation	Yes, per module
Power consumption through UP during normal operation	130 mA (depending on output loads)
Connections	Terminals 1.8, 2.8, 3.8, and 4.8 for +24 V (UP) as well as 1.9, 2.9, 3.9 and 4.9 for 0 V (ZP))
Max. length of analog cables, conductor cross section > 0.14 mm <sup>2</sup> (~26 AWG)	100 m (328.08 ft)
Conversion error of the analog values caused by non-linearity, adjustment error at factory and resolution within the normal range	Typically 0.5 %, max. 1 %
Dimensions	67.5 x 76 x 54 mm / 2.66 x 2.99 x 2.13 inch width x height x depth
Weight	Approx. 130 g / 4.6 oz
Mounting position	Horizontal or vertical with limitations (output load per group 50 % at 40°C (104°F))
Cooling	The natural convection cooling must not be hindered by cable ducts or other parts in the mounting cabinet.

Technical data analog inputs AI 731F	
Number of channels per module	8
Distribution of channels into groups	2 groups of 4 channels each
Connections to the channels I0- to I3	Terminals 1.0 to 1.7 and terminals 2.0 to 2.7
Connections to the channels I4- to I7-	Terminals 3.0 to 3.7 and Terminals 4.0 to 4.7
Type of inputs	bipolar (not in the case of current or Pt100/Pt1000/ Ni1000/Cu50/resistor)
Electrical isolation	against internal supply and other modules
Configurability	Digital input, -50...+50 mV, -500...+500 mV, -1...+1V, -5...+5V, -10...+10V, 0...+5V, 0...+10V, -20...+20mA, 0/4...20 mA, Pt100/1000, Ni1000, Cu50, resistor, thermocouple types J, K, N,S,T(each input can be configured individually)



### Technical data analog inputs AI 731F

Channel input resistance	Voltage: > 100 kOhm, current: approx. 330 Ohm
Time constant of the input filter	Line-frequency suppression 50 Hz, 60 Hz, none
Indication of the input signals	one yellow LED per channel
Conversion cycle	1ms (none), 100ms (60 Hz), 120ms(50 Hz) per channel
Resolution	Range unipolar 15 bits
	Range bipolar 15 Bit + sign
Unused voltage inputs	are configured as "unused"
Unused current inputs	have a low resistance, can be left open-circuited
Surge protection	Yes

### Technical data analog inputs AI 731F, if used as digital inputs

Number of channels per module	Max. 8
Distribution of channels into groups	2 groups of 4 channels each
Connections to channels I0+ to I3+	Terminals 2.0, 2.2, 2.4, 2.6
Connections to channels I4+ to I7+	Terminals 4.0, 4.2, 4.4, 4.6
Reference potential for the inputs	Terminals 1.8, 2.8, 3.8 and 4.8 (ZP)
Input signal delay	Typically 2 ms
Indication of the input signals	One LED per channel
Input signal voltage	24 V DC
Signal 0	-30 V...+5 V
Undefined signal	+5 V...+13 V
Signal 1	+13 V...+30 V
Input current per channel	
Input voltage +24 V	typically 5mA
Input voltage +5 V	typically 1mA
Input voltage +15 V	typically 3.1 mA
Input voltage +30 V	< 7 mA
Input resistance	approx. 4.8 kOhm



## 5.2.5.4 Analog output module AO 723F

Name	Short Description	Article No.
AO 723F	Analog output module 16 AO: +-10 V, 0/4-20 mA max. 8 AO usable as current outputs 12 Bit + sign, 2-wire, 24 VDC 8 W TU 715F /TU 716F (terminal unit not included)  – Profibus Remote I/O – Direct I/O for AC 700F and AC 900F	3BDH000384R0001

It has 16 channels with the following features:

- 16 configurable analog outputs in two groups (1.0...2.7 and 3.0...4.7)

5

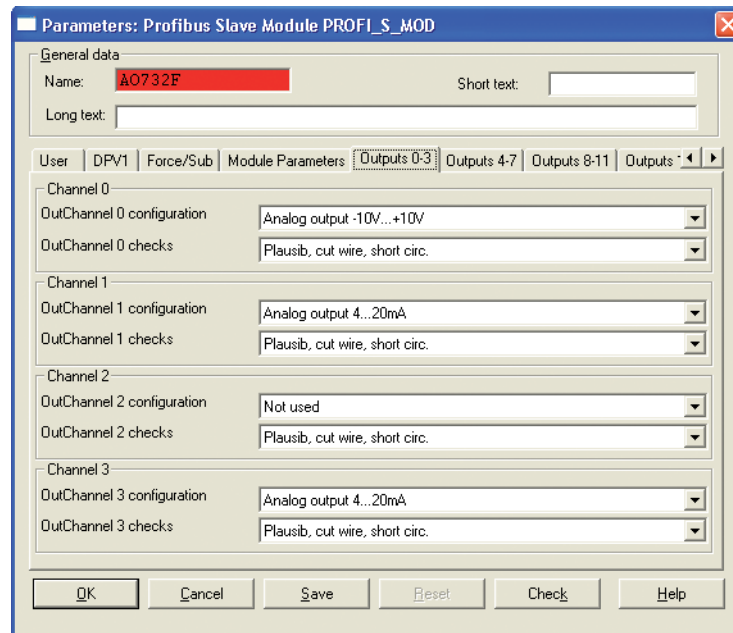

Figure 10: AO 723F output configuration using predefined template; configurable channels

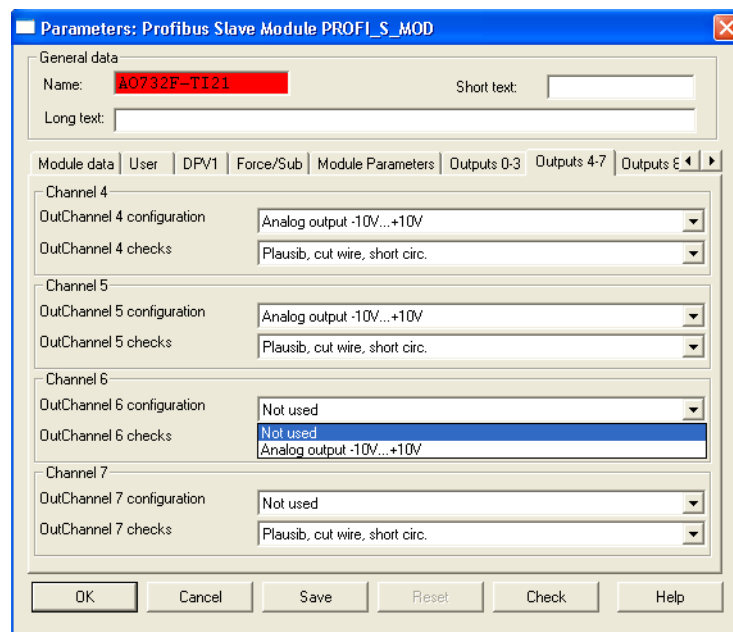

Figure 11: Output group 2 with voltage only channels

## Technical data

### Functionality AO 723F

Outputs	16 analog outputs, individually configurable for: unused (default setting) -10 V...+10 V 0...20 mA 4...20 mA
Resolution of the analog channels	Voltage 10 V... +10 V: 12 bits plus sign Current 0...20 mA, 4...20 mA: 12 bits Temperature: 0.1 °C (0.18 °F)
Power supply	internal: through the expansion bus interface (I/O Bus) external: via the terminals ZP and UP (process voltage 24 V DC)
Potential separation	module-wise
LEDs	19 LEDs for signals and error messages

### Technical data AO 723F

Process voltage	
Rated value	24 V DC
Max. ripple	5 %
Protection against reversed voltage	Yes
Rated protection fuse on UP	10 A fast
Electrical isolation	Yes, per module
Current consumption from UP at normal operation	0.15 A + output load
Inrush current from UP (at power up)	0.020 A <sup>2</sup> s
Connections	Terminals 1.8 – 4.8 for +24 V (UP) and 1.9 - 4.9 for 0 V (ZP)
Max. length of analog cables, conductor cross section > 0.14 mm <sup>2</sup> (~26 AWG)	100 m (328.08 ft)
Conversion error of the analog values caused by non-linearity, adjustment error at factory and resolution within the normal range	typically 0.5 %, max. 1 %
Dimensions	67.5 x 76 x 54 mm / 2.66 x 2.99 x 2.13 inch width x height x depth
Weight (without the terminal unit)	approx. 300 g/10.58 oz.
Mounting position	horizontal or vertical with limitations (output load per group 50 % at 40°C (104°F))
Cooling	the natural convection cooling must not be hindered by cable ducts or other parts in the mounting cabinet.

**Technical data of analog outputs AO 723F**

Number of channels per module	16, O0...O3 and O8...O11 for voltage and current, and channels O4...7 and O12...15 only for voltage
Distribution of channels into groups	2 group of 8 channels
Channels O0-...O7-	Terminals 1.0...1.7
Channels O0+...O7+	Terminals 2.0...2.7
Channels O8-...O15-	Terminals 3.0...3.7
Channels O8+...O15+	Terminals 4.0...4.7
Output type	bipolar with voltage, unipolar with current
Electrical isolation	against internal supply and other modules
Configurability	-10...+10 V, 0...20 mA, 4...20 mA (each output can be configured individually), current output in channels 0...3 only
Output resistance (load), as current output	0...500 Ω
Output load capacity, as voltage output	max. ±10 mA
Indication of the output signals	one LED per channel
Resolution	12 bits (+ sign)
Unused outputs	can be left open circuited

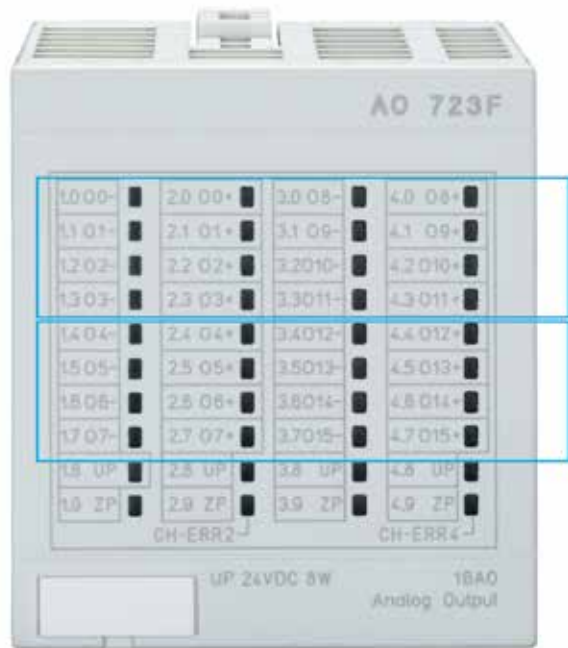

Each channel is configurable as unused, voltage or current

Each channel is configurable as unused or voltage



## 5.2.5.5 Analog input/output module AX 721F

Name	Short Description	Article No.
AX 721F	Analog input/output module 4 AI: +-10 V, 0/4-20 mA, RTD, 24 VDC 4 AO: +-10 V, 0/4-20 mA 12 Bit + sign, 2-wire, 24 VDC 5 W TU 715F /TU 716F (terminal unit not included)  – Profibus Remote I/O – Direct I/O for AC 700F and AC 900F	3BDH000370R0001

It has 8 channels with the following features:

- 4 configurable analog inputs in one group (1.0...2.3)
- 4 configurable analog outputs in one group (3.0...4.3)

The technical data correspond to the input and output values. The inputs and outputs are electrically isolated from the other electronic circuitry of the module. There is no potential separation between the channels.

### Technical data

Functionality AX 721F	
Inputs	4 analog inputs, individually configurable for: unused (default setting)
	0...10 V
	-10 V...+10 V
	0...20 mA
	4...20 mA
	Pt100, -50 °C (-58 °F)...+400 °C (+752 °F) (2-wire)
	Pt100, -50 °C (-58 °F)...+400 °C (+752 °F) (3-wire), requires 2 channels
	Pt100, -50 °C (-58 °F)...+70 °C (+158°F) (2-wire)
	Pt100, -50 °C (-58 °F)...+70 °C (+158°F) (3-wire), requires 2 channels
	Pt1000, -50 °C (-58 °F)...+400 °C (+752 °F) (2-wire)
	Pt1000, -50 °C (-58 °F)...+400 °C (+752 °F) (3-wire), requires 2 channels
	Ni1000, -50 °C (-58 °F)...+150 °C (+302 °F) (2-wire)
	Ni1000, -50 °C (-58 °F)...+150 °C (+302 °F) (3-wire), requires 2 channels
	0...10 V with differential inputs, requires 2 channels
-10 V...+10 V with differential inputs, requires 2 channels digital signals (digital input)	
Outputs	4 analog outputs, individually configurable for: unused (default setting)
	0...10 V
	-10 V...+10 V
	0...20 mA
	4...20 mA

Functionality AX 721F	
Resolution of the analog channels	Voltage -10 V... +10 V: 12 bits plus sign Voltage 0...10 V: 12 bits Current 0...20 mA, 4...20 mA: 12 bits
Power supply	Temperature: 0.1 °C/0.18 °F internal: through the expansion bus interface (I/O Bus) external: via the terminals (process voltage 24 V DC)
Potential separation	Module-wise
LEDs	11 LEDs for signals and error messages

Technical data AX 721F	
Process voltage	
Rated value	24 V DC
Max. ripple	5 %
Protection against reversed voltage	Yes
Rated protection fuse on UP	10 A fast
Electrical isolation	Yes, per module
Current consumption from UP at normal operation	0.10 A + output load
Inrush current from UP (at power up)	0.020 A <sup>2</sup> s
Connections	Terminals 1.8, 2.8, 3.8 and 4.8 for +24 V (UP) and 1.9, 2.9, 3.9 and 4.9 for 0 V (ZP)
Max. length of analog cables, conductor cross section > 0.14 mm <sup>2</sup> (~26 AWG)	100 m (328.08 ft)
Conversion error of the analog values caused by non-linearity, adjustment error at factory and resolution within the normal range	Typically 0.5 %, max. 1 %
Dimensions (width x height x depth) (without the Terminal Unit)	67.5 x 76 x 54 mm / 2.66 x 2.99 x 2.13 inch
Weight	300 g/10.58 oz.
Mounting position	Horizontal or vertical with limitations (output load per group 50 % at 40°C (104°F))
Cooling	The natural convection cooling must not be hindered by cable ducts or other parts in the mounting cabinet

### Technical data analog inputs AX 721F

Number of channels per module	4
Distribution of channels into groups	1 group of 4 channels
Connections to channels I0- to I3-	Terminals 1.0 to 1.3
Connections to channels I0+ to I3+	Terminals 2.0 to 2.3
Type of Inputs	Bipolar (not in the case of current or Pt100/Pt1000/ Ni1000)
Electrical isolation	Against internal supply and other modules
Configurability	0...10 V, -10...+10 V, 0/4...20 mA, Pt100/1000, Ni1000 (each input can be configured individually)
Channel input resistance	Voltage: > 100 kΩ, current: approx. 330 Ω
Time constant of the input filter	Voltage: 100 μs, current: 100 μs
Indication of the input signals	one LED per channel
Conversion cycle	2 ms (for 8 inputs + 8 outputs), with Pt/Ni...1 s
Resolution	Range 0...10 V: 12 bits Range -10...+10 V: 12 bits + sign Range 0...20 mA: 12 bits Range 4...20 mA: 12 bits
Unused voltage inputs	Are configurable as "unused"
Unused current inputs	Have a low resistance, can be left open circuited
Surge protection	Yes

### Technical data analog inputs if they are used as digital inputs AX 721F

Number of channels per module	Max. 4
Distribution of channels into groups	1 group of 4 channels
Connections to channels I0+ to I3+	Terminals 2.0 to 2.3
Reference potential for the inputs	Terminals 1.8, 2.8, 3.8 and 4.8 (ZP)
Input signal delay	Typically 8 ms, configurable from 0.1 to 32 ms
Indication of the input signals	One LED per channel
Input signal voltage	24 V DC
Signal 0	-30 V...+5 V
Undefined signal	+5 V...+13 V
Signal 1	+13 V...+30 V
Input current per channel	
Input voltage +24 V	Typically 7 mA
Input voltage +5 V	Typically 1.4 mA
Input voltage +15 V	Typically 4.3 mA
Input voltage +30 V	< 9 mA
Input resistance	Approx. 3.5 kΩ

#### Technical data analog outputs AX 721F

Number of channels per module	4, all channels for voltage, the first 4 are also for current
Distribution of channels into groups	1 group of 4 channels
Channels O0-...O3-	Terminals 3.0...3.3
Channels O0+...O3+	Terminals 4.0...4.3
Output type	bipolar with voltage, unipolar with current
Electrical isolation	against internal supply and other modules
Configurability	-10...+10 V, 0...20 mA, 4...20 mA (each output can be configured individually), current output in channels 0...3 only
Output resistance (load), as current output	0...500 Ohm
Output load capacity, as voltage output	max. $\pm 10$ mA
Indication of the output signals	one LED per channel
Resolution	12 bits (+ sign)
Unused outputs	can be left open circuited



## 5.2.5.6 Analog input / output module AX 722F



Name	Short Description	Article No.
AX 722F	<p>Analog input / output module</p> <p>8 AI: <math>\pm 10</math> V 0/4-20 mA 24 VDC, Pt100.</p> <p>8 AO: <math>\pm 10</math> V 0/4-20 mA 24 VDC.</p> <p>12 bit + Sign, 2-wire, 24 VDC 5 W.</p> <p>Without terminal unit.</p> <ul style="list-style-type: none"> <li>- Profibus Remote I/O</li> <li>- Direct I/O for AC 700F and AC 900F</li> </ul>	3BDH000377R0001

The AX 722F module offers even more flexibility, as it combines analog input and output channels in one module with 16 channels. Eight of these channels can be individually configured as inputs, which can again sense voltage, current, or temperatures.

Furthermore four channels can be configured as analog voltage outputs ( $-10$  V to  $+10$  V) or analog current outputs ( $0 \dots 20$  mA or  $4 \dots 20$  mA) and the remaining four channels can provide voltage signals in the range from  $-10$  V to  $+10$  V.

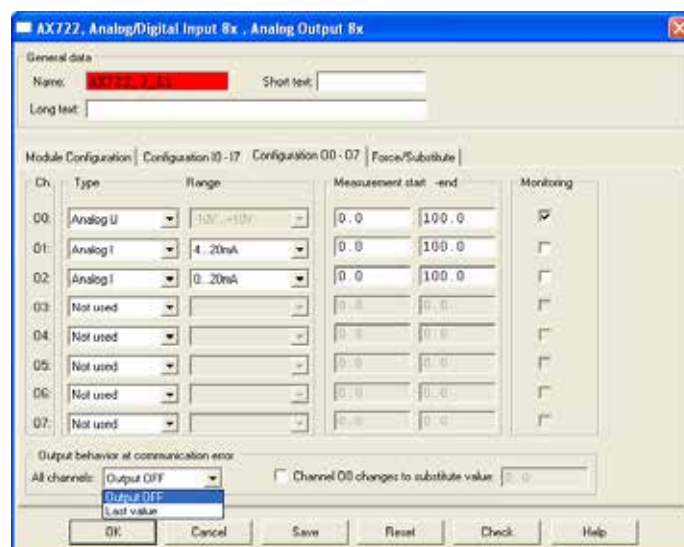
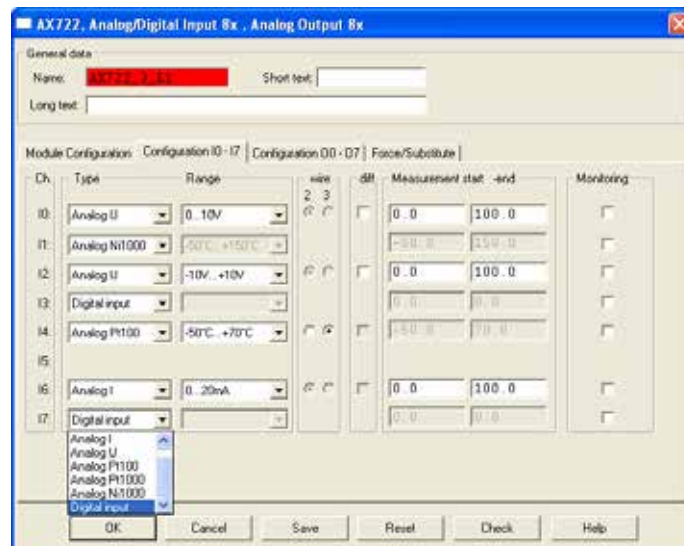

Figure 12: AX 722F options

## Technical data

### Functionality AX 722F

8 analog inputs, (channels I0 - I7) individually configurable for	Unused (default setting)
	0...10 V
	-10 V...+10 V
	0...20 mA
	4...20 mA
	Pt100, -50 °C (-58 °F)...+400 °C (+752 °F)
	2-wire or
	3-wire, requires 2 channels
	Pt100, -50 °C (-58 °F)...+70 °C (+158 °F)
	2-wire or
3-wire, requires 2 channels	
Pt1000, -50 °C (-58 °F)...+400 °C (+752 °F)	
2-wire or	
3-wire, requires 2 channels	
Ni1000, -50 °C (-58 °F)...+150 °C (+302 °F)	
2-wire or	
3-wire, requires 2 channels	
0...10 V with differential inputs, requires 2 channels	
-10 V...+10 V with differential inputs, requires 2 channels	
Digital signals (digital input)	
4 analog outputs, (channels O0 - O3) individually configurable for	Unused (default setting)
	-10 V...+10 V
	0...20 mA
4 analog outputs, (channels O4 - O7) individually configurable for	4...20 mA
	unused (default setting)
	-10 V...+10 V

### Technical data AX 722F

LED displays	19 LEDs for signals and error indication, where the brightness depends on the current (or signal level)
Internal power supply	Through the expansion bus interface (I/O-Bus)
External power supply	Via the terminals ZP and UP (process voltage 24 VDC) of TU 715F
Process voltage	
Rated value	24 VDC
Max. ripple	5%
Protection against reversed voltage	Yes
Rated protection fuse on UP	10 A fast
Electrical isolation	Yes, per module
Current consumption from UP at normal operation	0.10 A output loads
Inrush current from UP (at power up)	0.020 A <sup>2</sup> s

### Technical data AX 722F

Connections	Terminals 1.8 - 4.8 for +24 V (UP) and 1.9 - 4.9 for 0 V (ZP)
Max. length of analog cables, conductor cross section > 0.14 mm <sup>2</sup> (~26 AWG)	100 m / 328 ft.
Conversion error of the analog values caused by non-linearity, adjustment error at factory and resolution within the normal range	Typ. 0.5 %, max. 1 %
Dimensions (Width x height x depth)	67.5 x 76 x 54 mm / 2.66 x 2.99 x 2.13 inches
Weight (without the Terminal Unit)	approx. 300 g / 10.58 oz.
Cooling	The natural convection cooling must not be hindered by cable ducts or other parts in the mounting cabinet.

### Technical data of the analog inputs AX 722F

Number of channels per module	8
Distribution of the channels into groups	1 group of 8 channels
Connections of the channels I0- to I7-	Terminals 1.0 to 1.7
Connections of the channels I0+ to I7+	Terminals 2.0 to 2.7
Electrical isolation	Against internal supply and other modules
Configuration	0...10 V, -10...+10 V, 0/4...20 mA, Pt100/1000, Ni1000 (each channel can be configured individually)
Channel input resistance	Voltage: > 100 kOhm, current: ca. 330 Ohm
Time constant of the input filter	Voltage: 100 µs, current: 100 µs
Indication of the input signals	One LED per channel
Conversion cycle	2 ms (for 8 inputs + 8 outputs), with Pt / Ni...1 s
Resolution	Range 0...10 V: 12 bits Range -10...+10 V: 12 bits + sign Range 0...20 mA: 12 bits Range 4...20 mA: 12 bits Temperature : 0.1 °C / 0.18 °F
Unused voltage inputs	Are configured as „unused“
Unused current inputs	Have a low resistance, can be left open-circuited
Overtoltage protection	Yes

### Technical data of the analog inputs, if they are used as digital inputs AX 722F

Number of channels per module	Max. 8
Distribution of channels into groups	1 group of 8 channels
Connections of the channels I0+ to I7+	Terminals 2.0 to 2.7
Reference potential for the inputs	Terminals 1.8 to 4.8 (ZP)
Input signal delay	Typ. 8 ms
Indication of the input signals	One LED per channel
Input signal voltage	24 VDC
Signal 0	-30 V...+5 V
Signal 1	+13 V...+30 V

### Technical data of the analog outputs AX 722F

Number of channels per module	8, all channels for voltage, the first 4 channels also for current
Distribution of channels into groups	1 group of 8 channels
Channels O0-...O7-	Terminals 3.0...3.7
Channels O0+...O7+	Terminals 4.0...4.7
Output type	Bipolar with voltage, unipolar with current
Electrical isolation	Against internal supply and other modules
Configurability	-10...+10 V, 0...20 mA, 4...20 mA (each output can be configured individually), current outputs only channels 0...3
Output resistance (load), as current output	0...500 Ohm
Output loadability, as voltage output	max. $\pm 10$ mA
Indication of the output signals	One LED per channel, where the brightness depends on the current (or signal level)
Resolution	12 bits (+ sign)
Unused outputs	Can be left open-circuited

## 5.2.6 Digital / analog I/O module

### 5.2.6.1 Digital / analog module DA 701F



Name	Short Description	Article No.
DA 701F	Digital / analog module 16 DI: 24 VDC 8 DI/DO: 24 VDC/0.5 A 4 AI: +-10 V 0/4-20 mA, RTD , 24 VDC 2 AO: +-10 V, 0/4-20 mA 12 Bit + sign, 1-wire, 24 VDC 200 W TU 715F /TU 716F (terminal unit not included)  – Profibus Remote I/O – Direct I/O for AC 700F and AC 900F	3BDH000371R0001

It has 30 channels with the following features:

- 16 digital inputs, 24 V DC
- 8 configurable digital inputs/outputs 24 V DC, 0.5 A max.
- 4 analog inputs, voltage, current and RTD, resolution 12 bits plus sign
- 2 analog outputs, voltage and current, resolution 12 bits plus sign

The technical data correspond to the input and output values. The inputs and outputs are electrically isolated from the other electronic circuitry of the module. There is no potential separation between the channels.

### Technical data

Functionality DA 701F	
Digital Inputs	16 (24 V DC; delay time configurable via software)
Configurable digital inputs/outputs	8 (24 V DC, 0.5 A max)
Analog inputs	4 (configurable via software), resolution 12 bits plus sign, voltage, current and RTD input
Analog outputs	2 (configurable via software), resolution 12 bits plus sign, voltage, current and RTD output
Power supply	Internal: through the expansion bus interface (I/O-Bus) external: via the terminals ZP and UP (process voltage 24 V DC)
Potential separation	Module-wise
LEDs	For system displays, indicating signal statuses, errors and power supply
Process supply voltage UP	
Connections	Terminals 1.8, 2.8, 3.8 and 4.8 for +24 V (UP) and 1.9, 2.9, 3.9 and 4.9 for 0 V (ZP)
Rated value	24 V DC
max. ripple	5 %
Protection against reversed voltage	Yes

Technical data DA 701F	
Rated protection fuse on UP	10 A fast
Electrical isolation	Yes, per module
Current consumption	0.07 A + max. 0.5 A per output
From UP	Approx. 1 mA at 24 V DC
From 24 V DC power supply at the terminals UP/L+ and ZP/M of the CPU/Bus Module	Approx. 5 mA
Inrush current from UP (at power-up)	0.04 A <sup>2</sup> s
Max. power dissipation within the module	6 W (outputs not loaded)
Dimensions (width x height x depth)	67.5 x 76 x 54 mm / 2.66 x 2.99 x 2.13 inch
Weight (without Terminal Unit)	Approx. 125g / 4.41 oz.
Mounting position	Horizontal or vertical with limitations (Output load per group is 50 % at 40°C (104°F))
Cooling	The natural convection cooling must not be hindered by cable ducts or other parts in the mounting cabinet.

Technical data digital inputs DA 701F		
Number of channels per module	16	
Distribution of the channels into groups	2 group of 8 channels	
Connections to the channels DI0 to DI7	Terminals 1.0 to 1.7	
Connections to the channels DI8 to DI15	Terminals 2.0 to 2.7	
Reference potential for all inputs	Terminal 1.9...3.9 (minus pole of the process supply voltage, signal name ZP)	
Electrical isolation	From the rest of the module	
Indication of the input signals	One yellow LED per channel, the LED is ON when the input signal is high (signal 1)	
Input type acc. to EN 61131-2	Type 1	
Input delay (0->1 or 1->0)	Typically 0.1 ms, configurable from 0.1...32 ms	
Input signal voltage	24 V DC	
Signal 0	-3 V...+5 V	
Undefined signal	> +5 V...< +15 V	
Signal 1	+15 V...+30 V	
Ripple with signal 0	Within -3 V...+5 V	
Ripple with signal 1	Within +15 V...+30 V	
Input current per channel		
Input voltage +24 V	typically 5 mA	
Input voltage +5 V	> 1 mA	
Input voltage +15 V	> 2 mA	
Input voltage +30 V	< 8 mA	
Max. cable length	Shielded	1000 m (3280.83 ft)
	Unshielded	600 m (1968.50 ft)

### Technical data digital inputs / outputs DA 701F

Number of channels per module	8 inputs/outputs (with transistors)
Distribution of the channels into groups	1 groups of 8 channel
If channels are used as inputs: Channels DC16...DC23	Terminals 4.0...4.7
If channels are used as outputs: Channels DC16...DC23	Terminals 4.0...4.7
Indications of the input/output signals	1 yellow LED per channel, the LED is ON when the input/output signal is high (signal 1)
Electrical isolation	Yes, per module

### Technical data digital inputs / outputs DA 701F if used as inputs

Number of channels per module	8
Distribution of the channels into groups	1 groups of 8 channel
Channels DC16...DC23	Terminals 4.0...4.7
Reference potential for all inputs	Terminals 1.9...4.9 (Minus pole of the supply voltage, signal name ZP)
Indication of the input signals	1 yellow LED per channel, the LED is ON when the input signal is high (signal1)
Input type acc. to EN 61131-2	Type 1
Input delay (0->1 or 1->0)	Typically 0.1 ms, configurable from 0.1...32 ms
Input signal voltage	24 V DC
Signal 0	-3 V...+5 V
Undefined signal	> +5 V...< +15 V
Signal 1	+15 V...+30 V
Ripple with signal 0	Within -3 V...+5 V
Ripple with signal 1	Within +15 V...+30 V
Input current per channel	
Input voltage +24 V	Typically 5 mA
Input voltage +5 V	> 1 mA
Input voltage +15 V	> 2 mA
Input voltage +30 V	< 8 mA
Max. cable length	
Shielded	1000 m (3280.83 ft)
Unshielded	600 m (1968.50 ft)

\* Due to the direct connection to the output, the demagnetizing varistor is also effective at the input. This is why the difference between UPx and the input signal may not exceed the clamp voltage of the varistor. The varistor limits the voltage to approx. 36 V. Following this, the input voltage must range from -12 V to +30 V when UPx = 24 V and from -6 V to +30 V when UPx = 30 V.

Technical data digital inputs / outputs DA 701F if used as outputs		
Number of channels per module	8	
Distribution of the channels into groups	1 groups of 8 channel	
Channels DC16...DC23	Terminals 4.0...4.7	
Reference potential for all outputs	Terminals 1.9...4.9 (Minus pole of the supply voltage, signal name ZP)	
Common power supply voltage	For all output terminals 1.8, 2.8, 3.8 and 4.8 (plus pole of the supply voltage, signal name UP)	
Output voltage for signal 1	UP (-0.8 V)	
Output current		
Rated value per channel	500 mA @ UP = 24 V	
Max. value (all channels together)	4 A	
Leakage current with signal 0	<0.5 mA	
Fuse for UP	10 A fast	
Demagnetization with inductive DC load	Via internal varistors	
Output switching frequency		
With inductive loads	Max. 0.5 Hz	
With lamp loads	11Hz max. @ 5W max.	
Overload message (I >0.7 A)	Yes	
Output current limitation	Yes, after approx. 100 ms	
Resistance to feedback against 24 V signals	Yes (Software controlled supervision)	
Max. cable length	Shielded	1000 m (3280.83 ft)
	Unshielded	600 m (1968.50 ft)



### Technical data analog inputs DA 701F

Number of channels per module	4
Distribution of the channels into groups	1 groups of 4 channel
Channels AI0+...AI3+	Terminals 3.0...3.3
Reference potential for AI0+...AI3+	Terminals 3.4 (AI-) for voltage and RTD measurement Terminal 1.9, 2.9, 3.9 and 4.9 for current measurement
Input type	
Unipolar	Voltage 0...10 V, current or Pt100/Pt1000/Ni1000
Bipolar	Voltage -10...+10V
Configurability	0...10 V, -10...+10 V, 0/4...20 mA, Pt1000/1000, Ni1000 (each input can be configured individually)
Channel input resistance	Voltage: >100 k $\Omega$ , current: approx. 330 $\Omega$
Time constant of the input filter	Voltage: 100 $\mu$ s, current: 100 $\mu$ s
Indication of the input signals	1 LED per channel (brightness depends on the value of the analog signal)
Conversion cycle	1 ms (for 4 inputs + 2 outputs); with RTDs Pt/Ni... 1s
Resolution	Range 0...10 V: 12 Bits Range -10...+10 V: 12 Bits +sign Range 0...20 mA: 12 Bits Range 4...20 mA: 12 Bits Range RTD (Pt100, Pt1000, Ni1000): 0.1°C (°F)
Unused inputs	Configured as 'unused'
Overvoltage protection	Yes

#### Technical data analog inputs DA 701F if used as digital inputs

Number of channels per module	Max. 4
Distribution of the channels into groups	1 groups of 4 channel
Channels AI0+...AI3+	Terminals 3.0...3.3
Reference potential for all inputs	Terminals 1.9, 2.9, 3.9 and 4.9 (ZP)
Indication of the input signals	1 LED per channel
Input signal voltage	24 V DC
Signal 0	-30 V...+5 V
Undefined signal	+5 V...+13 V
Signal 1	+13 V...+30 V
Input current per channel	
Input voltage +24 V	typically 7 mA
Input voltage +5 V	typically 1.4 mA
Input voltage +15 V	typically 3.7 mA
Input voltage +30 V	< 9 mA
Input resistance	Approx. 3.5 kΩ

## 5.2.7 S700 I/O terminal units

Name	Short Description	Article No.
TU 705F	FBP terminal unit, 24 VDC Screw type terminals	3BDH000389R0001
TU 706F	FBP terminal unit, 24 VDC Spring type terminals	3BDH000390R0001
TU 709F	PROFIBUS terminal unit 24 VDC Screw type terminals	3BDH000397R0005
TU 710F	PROFIBUS terminal unit 24 VDC Spring type terminals	3BDH000398R0005
TU 715F	I/O terminal unit, 24 VDC Screw type terminals, 1/2 wire.	3BDH000378R0001
TU 716F	I/O terminal unit, 24 VDC Spring type terminals, 1/2 wire.	3BDH000382R0001
TU 731F	I/O terminal unit, 230 VAC Screw type terminals	3BDH000380R0001
TU 732F	I/O terminal unit, 230 VAC Spring type terminals	3BDH000381R0001

The upper area of a terminal block is designed for the connection of an I/O module or a PROFIBUS communication interface. In the lower area, the field cables are connected to up to 32 I/O terminals. The terminal blocks ensure the electrical connection of sensors and actuators. I/O modules can thus be removed or replaced without detaching the field wiring.

The I/O Bus in the upper terminal block area transmits I/O data and diagnostic data between a CPU module or a PROFIBUS communication interface and the I/O modules. This I/O Bus can be extended using the terminal blocks TU 715F/716F and TU 731F/732F in order to increase the number of I/O modules.

The maximum number of I/O terminal blocks depends on the application and/or configuration:

- AC 700F with direct I/O: max. 8 I/O modules
- AC 900F with direct I/O: max. 10 I/O modules
- PROFIBUS remote I/O: number of I/O modules determined by the PROFIBUS communication interface and the type of I/O modules used

Terminal blocks for PROFIBUS communication interfaces are additionally provided with a PROFIBUS connection or a fieldbus plug connection to connect the PROFIBUS either directly or via the PDP22 fieldbus plug (FieldBusPlug).

The I/O module or the communication interface is plugged to the terminal block and locked in place by two mechanical locks. The terminal block is then mounted to a DIN rail together with the module. Wall mounting of the terminal block using the TA526 accessory for wall mounting and two screws is alternatively possible.

The terminal blocks are available either with screw terminals or spring-cage terminals. The information provided in the following table applies to both versions.

### 5.2.7.1 Screw/spring-cage terminals

Number of conductors per terminal	Conductor type	Cross-section
1	solid	0.08 ... 2.5 mm <sup>2</sup>
1	flexible	0.08 ... 2.5 mm <sup>2</sup>
1 with wire end ferrule	flexible	0.25 ... 1.5 mm <sup>2</sup>

### 5.2.7.2 Dimensional drawings I/O terminal units

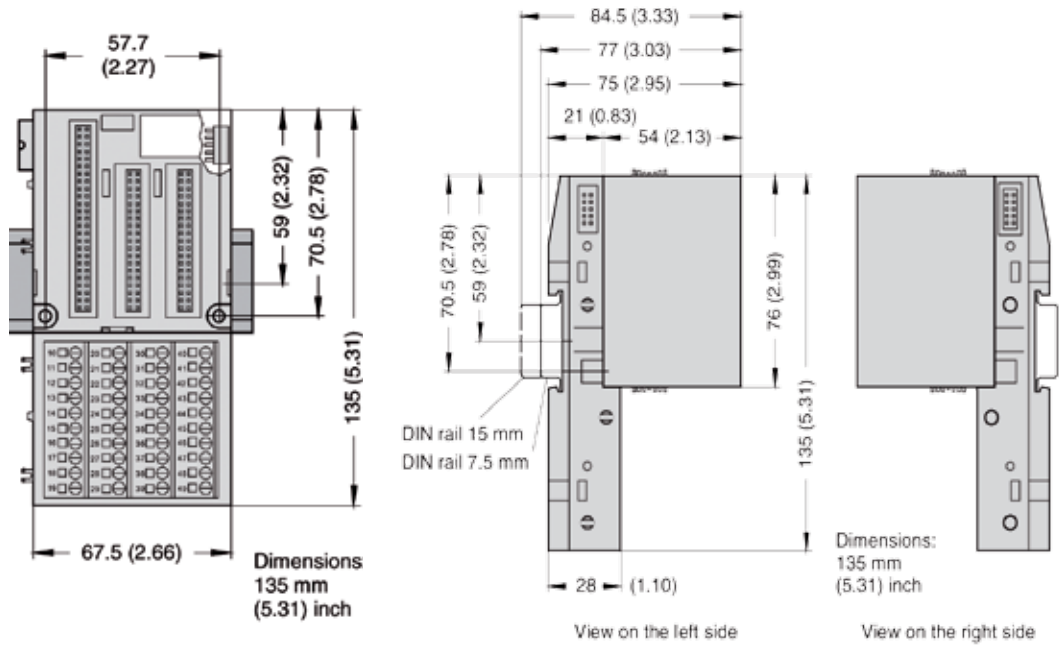

### 5.2.7.3 TU 705F / TU 706F



TU 705F



TU 706F

Name	Short Description	Article No.
TU 705F	FBP terminal unit, 24 VDC Screw type terminals	3BDH000389R0001
TU 706F	FBP terminal unit, 24 VDC Spring type terminals	3BDH000390R0001

The FBP Terminal Units TU 705F (screw type terminal) and TU 706F (spring type terminal) are used as a socket for the FBP Interface Module, The FBP Interface Modules is placed on the FBP Terminal Unit and locked into place using two mechanical locks. To loosen this connection a screw driver should be inserted in the recess provided and the Terminal units are carefully pulled away. All electrical connections are made through the Terminal Unit, which allows removal and replacement of the FBP Interface Module without disturbing the wiring at the FBP terminal unit.

The terminals 1.8 to 2.8 and 1.9 to 2.9 are electrically interconnected within the FBP Terminal Unit and always have the same assignment irrespective of which module is inserted:

- Terminals 1.8 to 2.8: Process voltage UP = +24 V DC
- Terminals 1.9 to 2.9: Process voltage ZP = 0 V

The assignment of other terminals is dependent on the FBP Interface Module inserted. The supply voltage of +24 V DC device-voltage for the electronic circuitry of the device comes from the FieldBusPlug

### Technical data

Technical data TU 705F / TU 706F	
Design	Screw terminals / spring-cage terminals
Interface of the fieldbus plug (FieldBusPlug)	M12, 5 pins
Number of channels per module	16
Subdivision into groups	2 groups of 8 channels each 1.0...1.7, 2.0...2.7
Rated voltage	24 V DC
Max. admissible total current	10 A, between the terminals 1.8...2.8 and 1.9...2.9

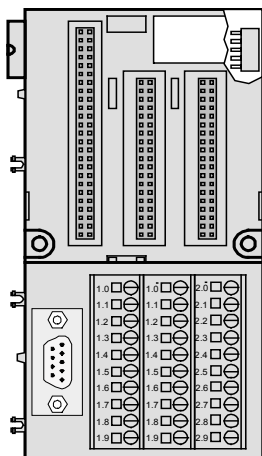

### 5.2.7.4 TU 709F / TU 710F

Name	Short Description	Article No.
TU 709F	Profibus terminal unit, 24 VDC Screw type terminals	3BDH000397R0005
TU 710F	Profibus terminal unit, 24 VDC Spring type terminals	3BDH000398R0005

The TU 709F/710F terminal block serves as a base for the PROFIBUS communication interface CI 741F. The terminal block is rated for 24 V I/O signals. The following terminals are connected with each other inside the terminal block:

- Terminals 2.8 and 3.8: supply voltage UP = +24 V DC
- Terminals 2.9 to 4.9: reference potential ZP = 0 V for UP and UP3

The digital outputs DO0 to DO7 are equipped with an own power supply connection

UP3 (4.8) and can thus be separately protected and supplied. The power supply of the PROFIBUS interface, the I/O Bus and the other inputs/outputs is ensured by the UP.

## Technical data

Technical data TU 709F / TU 710F	
Design	Screw terminals / spring-cage terminals
PROFIBUS DP interface	9 pin Sub-D female connector (F)
Number of channels per module	24
Subdivision into groups	3 groups of 8 channels each 2.0...2.7, 3.0...3.7, 4.0...4.7
Rated voltage	24 V DC
Max. admissible total current	10 A, via terminals 2.8, 3.8, 4.8 and between 2.9...4.9



TU 715F



TU 716F

### 5.2.7.5 TU 715F / TU 716F

Name	Short Description	Article No.
TU 715F	I/O terminal unit, 24 VDC Screw type terminals, 1/2 wire.	3BDH000378R0001
TU 716F	I/O terminal unit, 24 VDC Spring type terminals, 1/2 wire.	3BDH000382R0001

The I/O Terminal Units TU 715F (screw type terminal) and TU 716F (spring type terminal) are used as a socket for the I/O module, which exclusively incorporates inputs and outputs for 24V DC digital or analog signals. The I/O modules (I/O expansion modules) are placed on the I/O Terminal Unit and locked into place using two mechanical locks. To loosen this connection a screw driver should be inserted in the recess provided and the Terminal Units are carefully pulled away. All electrical connections are made through the Terminal Unit, which allows removal and replacement of the I/O units without disturbing the wiring at the terminal unit.

The terminals 1.8 to 4.8 and 1.9 to 4.9 are electrically interconnected within the I/O Terminal Unit and always have the same assignment irrespective of which I/O expansion module is inserted:

- Terminals 1.8 to 4.8: Process voltage UP = +24 V DC
- Terminals 1.9 to 4.9: Process voltage ZP = 0 V

The assignment of other terminals is dependent on the I/O expansion module that is inserted. The supply voltage of +24 V DC device-voltage for the electronic circuitry of the device comes from the I/O expansion bus (I/O Bus) and from the CPU respectively.

## Technical data

Technical data TU 715F / TU 716F	
Design	Screw terminals / spring-cage terminals
Number of I/O channels	32
Subdivision into groups	4 groups of 8 channels each 1.0...1.7, 2.0...2.7, 3.0...3.7, 4.0...4.7
Rated voltage	24 V DC
Max. admissible total current	10 A, between the terminals 1.8...4.8 and 1.9...4.9



TU 731F



TU 732F

## 5.2.7.6 TU 731F / TU 732F

Name	Short Description	Article No.
TU 731F	I/O terminal unit, 230 VAC Screw type terminals	3BDH000380R0001
TU 732F	I/O terminal unit, 230 VAC Spring type terminals	3BDH000381R0001

The I/O Terminal Units TU 731F (with screw-type terminals) and TU 732F (with spring type terminals) are specifically designed for use with AC 700F/AC 900F/S700 I/O modules that incorporate 115-230 V AC inputs and/or 115-230 V AC relay outputs.

The input/output modules (I/O expansion modules) plug into the I/O terminal Unit. When properly seated, they are secured with two mechanical locks. All the electrical connections are made through the Terminal Unit, which allows removal and replacement of the I/O modules without disturbing the wiring at the Terminal Unit.

The terminals 1.8 to 4.8 and 1.9 to 4.9 are electrically interconnected within the I/O Terminal Unit and have always the same assignment, irrespective of which I/O expansion module is inserted:

- Terminals 1.8 to 4.8: Process voltage UP = +24 V DC
- Terminals 1.9 to 4.9: Process voltage ZP = 0 V

The assignment of the other terminals is dependent on the inserted expansion module (see the description of the used expansion module).

The supply voltage 24 V DC for the module's electronic circuitry comes from the I/O expansion bus (I/O-Bus) or from the FieldBusPlug or from the AC 700F or AC 900F CPU.

### Technical data TU 731F / TU 732 F

Design	Screw terminals / spring-cage terminals
Number of terminals	32
Distribution of the channels into groups	4 groups of 8 channels each (1.0...1.7, 2.0...2.7, 3.0...3.7, 4.0...4.7)
Rated voltage	230 V AC
Max. permitted total current	10 A, between the terminals 1.8...4.8 and 1.9...4.9

## 5.2.8 S 700 I/O Accessories

### 5.2.8.1 FieldBusPlug



Name	Short Description	Article No.
PDP22-FBP.025	FieldBusPlug, DP-V0/1, 0.25 m	1SAJ240100R1003
PDP22-FBP.050	FieldBusPlug, DP-V0/1, 0.5 m	1SAJ240100R1005
PDP22-FBP.100	FieldBusPlug, DP-V0/1, 1 m	1SAJ240100R1010
PDP22-FBP.200	FieldBusPlug, DP-V0/1, 2 m	1SAJ240100R1020
PDP22-FBP.500	FieldBusPlug, DP-V0/1, 5 m	1SAJ240100R1050

5

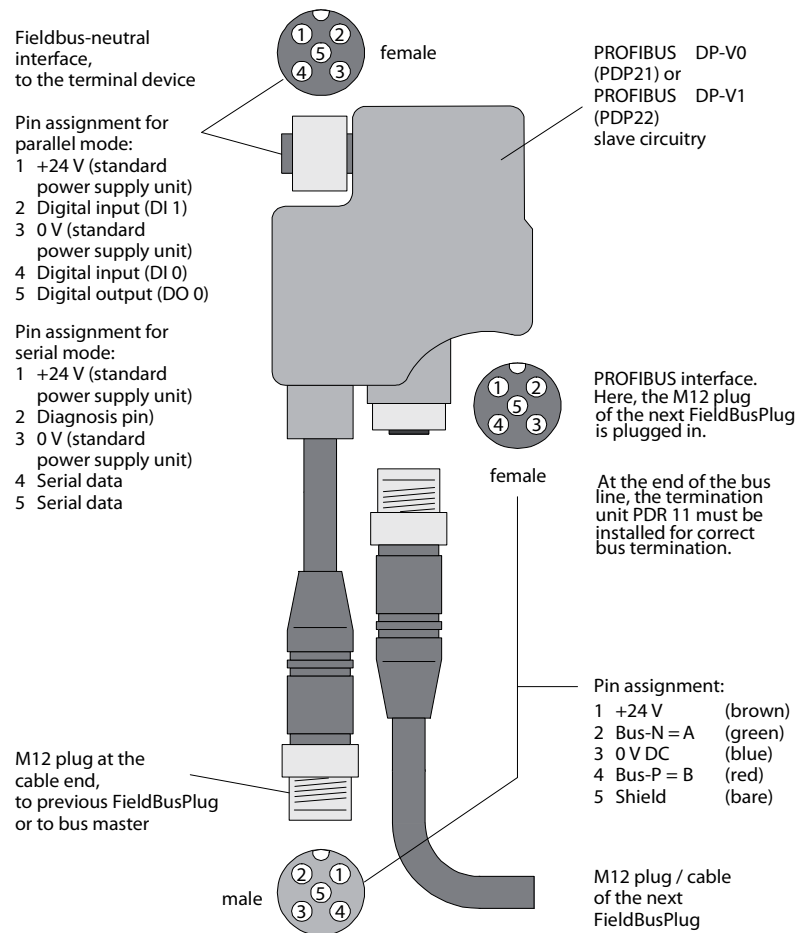

PDP22 represents a tee unit, which means that if the built in bus node in on of them fails then all remaining FieldBusPlugs are still connected with the bus master.

- A power unit, preferable situated near the bus master, is necessary to supply power to the FieldBusPlugs.
- A maximum baud rate of 12 Mbit/s is possible provided the termination on both ends is done correctly and the maximum bus length is not exceeded.



## 5.2.8.2 Markers for I/O modules

Name	Short Description	Article No.
TA523	Pluggable Marker Holder for I/O modules, 10 pcs. For labelling channels of I/O modules. The marking slips can be printed by users separately using a MS-Word based template.	1SAP180500R0001

Name	Short Description	Article No.
TA525	White Plastic Markers, 10 pcs. For labelling CPU and I/O modules in AC 700F.	1SAP180700R0001

## 5.2.8.3 Connectors



Name	Short Description	Article No.
PDM11-FBP.0	Male Assembling Connector	1SAJ924005R0001
PDF11-FBP.0	Female Assembling Connector	1SAJ924006R0001



Name	Short Description	Article No.
PDR11-FBP.150	Termination Unit	1SAJ924007R0001



Name	Short Description	Article No.
PDV12-FBP.0	Feed-In Connector, Code A-A	1SAJ924011R0001
PDV11-FBP.0	Feed-In Connector, Code B-A	1SAJ924008R0001

## 5.2.8.4 Cables



Name	Short Description	Article No.
PDX11-FBP.100	Extension Cable, 1 m	1SAJ924001R0010
PDX11-FBP.300	Extension Cable, 3 m	1SAJ924001R0030
PDX11-FBP.500	Extension Cable, 5 m	1SAJ924001R0050



Name	Short Description	Article No.
PDA11-FBP.050	Adapter-Cable, Dsub9-M12	1SAJ924009R0005
PDA12-FBP.050	Adapter-Cable, M12-Dsub9-M12	1SAJ924010R0005





## 5.3 S800 Remote I/O

S800 I/O is a comprehensive, distributed and modular process I/O system that communicates with parent controllers via PROFIBUS. Thanks to its broad connectivity, the system is able to communicate with a wide range of process control systems from both ABB and other suppliers. By permitting installation in the field, close to sensors and actuators, S800 I/O greatly reduces the installation cost by reducing the cost of cabling. It is possible to exchange modules and reconfigure the system during operation. Redundancy options allow a high degree of availability. With its cost-effective design and just 59 mm depth installation, S800L I/O modules are the perfect choice for PLC applications. Robust mechanics, one-piece handling, easy mounting and smart connections save your time in all phases of installation.

Furthermore, S800L I/O with a cost-effective design and smaller footprint is available. To withstand harsh environments, all S800 modules are compliant to G3 severity level ISA-S71.04 , Environmental Conditions for Process Measurement and Control Systems.

Note: The S800 modules that can be used with Freelance are listed here.

### 5.3.1 Communication

#### 5.3.1.1 Field communication interfaces

Name	Short Description	Article No.
CI801-eA	PROFIBUS DP-V1 Communication Interface  Including: 1x Power Supply Connector 1x TB807 ModuleBus Terminator  The basic system software loaded in CI801 does not support the following I/O modules: DI830, DI831, DI885, AI880A, DI880 and DO880.	3BSE022366R2
CI801 Engineering kit	SW 1.2  Including: 1x CD with GSD file, Memory Maps and Release Note. 1x Reference Manual Memory Maps for CI801.	3BSE038540R1300
CI840A-eA	Profibus DP-V1 Communication Interface. For 1+1 redundant operation.  Two CI840A and one TU847 or one TU846 must be ordered. The basic system software loaded in CI840 does not support the following I/O modules: DI830, DI831, DI885, AI880A, DI880, DO880 and ABB Drives.	3BSE041882R2
CI840 Engineering kit	SW 4.0  Including: 1x CD with GSD file, Memory Maps and Release Notes. 1x Reference Manual Memory Maps for CI840.	3BSE031694R4000
TU846	Module Termination Unit, MTU, for 1+1 CI840. Support for redundant I/O  Vertical mounting of modules. Including: 1x Power Supply Connector 2x TB807 ModuleBus Terminator.	3BSE022460R1

Name	Short Description	Article No.
TU847	Module Termination Unit for 1+1 CI840. Support for non-redundant I/O  Vertical mounting of modules. Including: 1x Power Supply Connector 1x TB807 ModuleBus Terminator.	3BSE022462R1
Front label set	FCI / AC 70 / TB  Sheet with 12 labels. For CI810, CI820, CI830, and TB820.	3BSC970089R1
Label set, item design	FCI / AC 70 / TB  Sheet with 40 labels. For CI810, CI820, CI830, and TB820.	3BSC970091R1
Mounting kit	For vertical mounting of CI801, CI840 and TB840 on a vertical DIN rail	3BSE040749R1
Mounting profile 1800	2 DIN rails and 1 cable duct  DIN rail length : 1650mm + 210mm (65") + (8.3")	3BSE049768R1
Al-profile	Al-profile with DIN Rail and Cable Duct, mounting 465 mm (19")  DIN rail length 429mm (16,9")	3BSE022255R1
Al-profile	Al-profile with DIN Rail and Cable Duct for RM550, mounting 592 mm (24")  DIN rail length 556mm (21,9")	3BSE022256R1

### 5.3.1.2 Upgrade kit and tool cables

Upgrading of CI801-eA or CI840A-eA to latest software version are available for download from ABB Library/SolutionsBank.

Item TK212A is cable connecting a PC to CI840A-eA for download of software. CI801-eA requires items TK212A and FS801K01 for download of software

Name	Short Description	Article No.
TK212A	Tool cable  RJ45 (male) to Dsub-9 (female), length 3 m. RJ45 8P8C plug (with shell). Cable : UL2464 26 AWG x 8C.	3BSC630197R1
FS801K01	Service adapter kit  Including: 1x Service adapter FS801 1x cable TK802 For connection of CI801 to PC. A cable TK812 is also needed.	3BSE038407R1

## 5.3.2 S800 I/O (eA) modules

### 5.3.2.1 S800 I/O (eA) Analog input modules

Name	Short Description	Article No.
AI810-eA	Analog Input, 1x8 channels 0(4)..20 mA, 0...10 V, 12 bit, single ended, 0.1%, Rated isolation 50 V. Use Module Termination Unit TU810, TU812, TU814, TU830, TU833, TU835, TU838.	3BSE008516R2
AI815-eA	Analog Input, 1x8 channels, HART 0(4)..20mA, 0(1)..5V, 12bit, single ended, 0.1%, Rated isolation 50V. Current limited transmitter power distribution. Use Module Termination Unit TU810, TU812, TU814, TU830, TU833, TU835 or TU838.	3BSE052604R2
AI820-eA	Analog Input, 4x1 channel +-20 mA, 0(4)..20 mA, +-10 V, +-5 V, 0(1)..5 V, diff., 5 0V CMV, 14 bit +sign. Rin(curr)250 Ohm, Rated isolation 50 V. Use Module Termination Unit TU810, TU812, TU814, TU830, TU833.	3BSE008544R2
AI825-eA	Analog Input, 4x1 channel, galvanically isolated -20..20 mA, 0(4)..20 mA, -10...10 V, 0(2)...10 V, Galvanically isolated channels. 14 bit+sign, 0.1%, Rated isolation 250 V. Use Module Termination Unit TU811, TU813, TU831.	3BSE036456R2
AI830A-eA	Analog Input, 1x8 channels RTD Pt100, Ni100/120, Cu10, R, Rated isolation 50 V. Use Module Termination Unit TU810, TU812, TU814, TU830, TU833.	3BSE040662R2
AI835A-eA	Analog Input, 8 channels, Thermocouple / mV Rated isolation 50 V. Use Module Termination Unit TU810, TU812, TU814, TU830, TU833.	3BSE051306R2
AI843-eA	Analog Input, Redundant or Single 1x8 channels Thermocouple / mV Rated isolation 50 V. Use Modules Termination Unit TU830, TU833, TU842, TU843.	3BSE028925R2
AI845-eA	Analog Input, redundant or single, 1x8 channels HART 0(4)..20 mA, 0(1)..5 V, 12 bit, single ended, 0.1%, Rated isolation 50 V. Current limited transmitter power distribution. Advanced on-board diagnostics. Use Module Termination Unit TU810, TU812, TU814, TU830, TU833, TU835, TU838, TU844, TU845.	3BSE023675R2
AI890	Analog Input, 1x8 channels with Intrinsic Safety Interface (4)..20 mA single ended 0.1%. Rated isolation 50 V. Use Module Termination Unit TU890 or TU891	3BSC690071R1

Name	Short Description	Article No.
AI893	Analog Input 8 channels, temperature measuring. Intrinsic Safety Interface, G3 compliant	3BSC690141R1
	For TC and RTD sensors. Rated isolation 50 V. Protection class G3. Use Module Termination Unit TU890 or TU891.	
AI895	Analog Input, 1x8 channels with Intrinsic Safety and HART, G3 compliant.	3BSC690086R1
	4..20 mA single ended 0,1%. Rated isolation 50 V. Protection class G3. Use Module Termination Unit TU890 or TU891.	

### 5.3.2.2 S800 I/O (eA) Analog output modules

Name	Short Description	Article No.
AO810V2-eA	Analog Output, 1x8 channels, 0(4)..20 mA	3BSE038415R2
	0(4)..20 mA, 14 bit RLmax 500/850 Ohm, Rated isolation 50 V. Use module Termination Unit TU810, TU812, TU814, TU830 or TU833.	
AO815-eA	Analog Output, 1x8 channels, HART	3BSE052605R2
	4..20mA, 12bit, 0.1%, RLmax 750 ohm, Rated isol. 50V. Use Module Termination Unit TU810, TU812, TU814, TU830 or TU833.	
AO820-eA	Analog Output, 4x1 channel	3BSE008546R2
	+..20 mA, 0(4)..20 mA, +-10 V, 12 bit+sign. Individ. isolation channels. RL max 500 Ohm, Rated isolation 50 V. Use Module Termination Unit TU810, TU812, TU814, TU830, TU833.	
AO845A-eA	Analog Output, redundant or single, 1x8 channels, HART	3BSE045584R2
	4...20 mA, 12 bit, 0.1%, RLmax 750 ohm, Rated isolation 50 V. Advanced on-board diagnostics. Use Module Termination Unit TU810, TU812, TU814, TU830, TU833, TU842, TU843.	
AO890	Analog Output, 1x8 channels with Intrinsic Safety Interface	3BSC690072R1
	0 (4)..20 mA 0,1%. RL max 750 Ohm Rated isolation 50 V. Use Module Termination Unit TU890 or TU891.	
AO895	Analog Output 1x8 channels with Intrinsic Safety and HART. G3 compliant	3BSC690087R1
	4..20 mA 0,1%. RL max 750 Ohm Rated isolation 50 V. Protection class G3. Use Module Termination Unit TU890 or TU891.	

### 5.3.2.3 S800 I/O (eA) Digital input modules

Name	Short Description	Article No.
DI810-eA	Digital Input, 24 VDC, 2x8 channels	3BSE008508R2
	Rated isolation 50 V. Use Module Termination Unit TU810, TU812, TU814, TU830, TU833, TU838.	
DI811-eA	Digital Input, 48 VDC, 2x8 channels	3BSE008552R2
	Rated isolation 50 V. Use Module Termination Unit TU810, TU812, TU814, TU830, TU833, TU838.	
DI814-eA	Digital Input, 24 VDC, 2x8 channels	3BUR001454R2
	Rated isolation 50 V. Use Module Termination Unit TU810, TU812, TU814, TU830, TU833, TU838.	
DI818-eA	Digital Input, 24 VDC, 2x16 channels	3BSE069052R2
	Rated isolation 50 V. Use Module Termination Unit TU818, TU819, TU830.	
DI820-eA	Digital Input, 120 VAC, 8x1 channel	3BSE008512R2
	Rated isolation 250 V. Use Module Termination Unit TU811, TU813, TU831.	
DI821-eA	Digital Input, 230 VAC, 8x1 channel	3BSE008550R2
	Rated isolation 250 V. Use Module Termination Unit TU811, TU813, TU831.	
DI828-eA	Digital Input, 120 V AC/DC, 16x1 channel	3BSE069054R2
	Rated isolation 250 V. Use Module Termination Unit TU851.	
DI840-eA	Digital Input, redundant or single, 24 VDC, 1x16 channels	3BSE020836R2
	Advanced On-Board diagnostics. Rated isolation 50 V. Use Module Termination Unit TU810, TU812, TU814, TU830, TU833, TU838, TU842, TU843.	
DI890	Digital Input, 8x1 channel with Intrinsic Safety Interface	3BSC690073R1
	Rated isolation 50 V. Use Module Termination Unit TU890 or TU891.	

### 5.3.2.4 S800 I/O (eA) Digital output modules

Name	Short Description	Article No.
DO810-eA	Digital Output, 24 VDC, 2x8 channels 0.5 A, Short circuit proof, Rated isolation 50 V. Use Module Termination Unit TU810, TU812, TU814, TU830, TU833.	3BSE008510R2
DO814-eA	Digital Output, current sinking, 2x8 channels 0,5 A, shortcut circuit proof, Rated isolation 50 V. Use Module Termination Unit TU810, TU812, TU814, TU830, TU833, TU838.	3BUR001455R2
DO815-eA	Digital Output, 24 VDC, 2x4 channels 2.0 A short circuit proof. Rated isolation 50 V. Use Module Termination Unit TU810, TU812, TU814, TU830, TU833.	3BSE013258R2
DO818-eA	Digital Output, 24 VDC, 2x16 channels 0.5A, Short circuit proof, Rated isolation 50V Use Module Termination Unit TU818, TU819, TU830.	3BSE069053R2
DO820-eA	Digital Output, Relay, normal open, 8x1 channel 24-230 VAC 3 A, cos phi>0.4, d.c. 42 W, Rated isolation 250 V. Use Module Termination Unit TU811, TU813, TU831, TU836, TU837.	3BSE008514R2
DO821-eA	Digital Output, Relay, normal closed, 8x1 channel 24-230 VAC 3 A, cos phi>0.4, d.c. 42 W, Rated isolation 250 V. Use Module Termination Unit TU811, TU813, TU831, TU836, TU837.	3BSE013250R2
DO828-eA	DO828 Digital Output, Relay Normally Open, 16x1 channel 5-250VAC and 5-125VDC, max 2A, Rated isolation 250V. Use Module Termination Unit TU851.	3BSE069055R2
DO840-eA	Digital Output, redundant or single, 2x8 channels 24 VDC, 0.5 A. Advanced On-board diagnostics. Rated isolation 50 V. Use Module Termination Unit TU810, TU812, TU814, TU830, TU833, TU842, TU843.	3BSE020838R2
DO890	Digital Output, 4x1 channel with Intrinsic Safety Interface Rated isolation 50 V. Use Module Termination Unit TU890 or TU891.	3BSC690074R1

### 5.3.2.5 S800 I/O (eA) Pulse counting modules

Name	Short Description	Article No.
DP820-eA	Pulse Counter RS-422, Current, 5 V, (12 V), 24 V  2 channels bidirectional pulse counters and frequency measurement. 1,5 MHz Rated isolation 50 V. Use Module Termination Unit TU810, TU812, TU814, TU830, TU833.	3BSE013228R2
DP840-eA	Pulse Counter or Frequency Measurement Module, redundant or single, 1x8 channels  20 kHz. Rated isolation 50 V. Use Module Termination Unit TU810, TU812, TU814, TU830, TU833, TU842, TU843, TU844, TU845.	3BSE028926R2

### 5.3.2.6 Label sets for S800 I/O modules

Name	Short Description	Article No.
Transparent film fronts	Set of 12 transparent plastic film fronts. To be used with ordinary paper quality.	3BSE072159R1
White colored plastic coated paper	One sheet of size A4. Original paper quality. No need to use transparent films.	3BSE072160R1

### 5.3.2.7 Module termination units for S800

Name	Short Description	Article No.
TU805K01	Termination Units  Termination Units for two or three wire connection of DI801 and DO801. Include 10 pcs of Termination Unit TU805.	3BSE035990R1
TU810V1	Compact Module Termination Unit 50 V  2x8 signal terminals, rated isolation 50 V.	3BSE013230R1
TU811V1	Compact Module Termination Unit 250 V  1x8 signal terminals rated isolation 250 V.	3BSE013231R1
TU812V1	Compact Module Termination Unit 50 V  With 25 pin D-sub connector, rated isolation 50 V. D-sub (female) connector is not enclosed.	3BSE013232R1
TU813	Compact Module Termination Unit 250 V  2x8 Signal terminals, Rated isolation 250 V. Detachable (pluggable) connectors are enclosed.	3BSE036714R1
TU814V1	Compact Module Termination Unit 50 V  2x8 Signal terminals, rated isolation 50 V. Detachable (pluggable) connectors are enclosed.	3BSE013233R1
TU818	Compact Module Termination Unit, MTU, 50V  1x32 (and 2x16) signal terminals, Rated isol. 50V	3BSE069209R1



Name	Short Description	Article No.
TU819	Compact Module Termination Unit, MTU, 50V With 2x25 pin D-sub connector, Rated isol. 50V, D-sub (female) connector is not enclosed	3BSE068891R1
TU830V1	Extended Module Termination Unit 50 V 2x16 signal terminals rated isolation 50 V.	3BSE013234R1
TU831V1	Extended Module Termination Unit 250 V 2x8 signal terminals rated isolation 250 V.	3BSE013235R1
TU833	Extended Module Termination Unit 50 V 2x16 signal terminals, Rated isolation 50 V. Spring-cage terminals.	3BSE038726R1
TU834	Extended Module Termination Unit 50 V Used with AI880 / AI880A. Rated isolation 50 V. Shunt Stick not included.	3BSE040364R1
TU835V1	Extended Module Termination Unit 50 V 8 fused power outlets, 8 signal terminals, rated isolation 50 V	3BSE013236R1
TU836V1	Extended Module Termination Unit 250 V 2x4 fused signals, 2x4 return terminals, 2x2 L terminals, 2x2 N terminals. Rated isolation 250 V.	3BSE013237R1
TU837V1	Extended Module Termination Unit 250 V 8x1 fused isolated signals, 8x1 L terminals, 2x6 N terminals. Rated isolation 250 V.	3BSE013238R1
TU838	Extended Module Termination Unit, MTU, 50V. 2x4 fused transducer power outlets, 16 signal terminals, 2x4 return terminals, 2x2 L+, 2x2 L- terminals, rated isol. 50V. Module is mounted horizontally.	3BSE008572R1
TU839	Extended Module Termination Unit, 250V 2x8 signal terminals, 2x4 fused sensor power, Rated isolation 250V.	3BSE046966R1
TU842	Module Termination Unit, MTU, for redundant applications, 50V. Used for AO845, DI840, DO840. Horizontal mounted DIN rail. Rated isolation 50V	3BSE020850R1
TU843	Module Termination Unit, MTU, for redundant applications, 50V. Used for AO845, DI840, DO840. Vertical mounted DIN rail. Rated isolation 50V.	3BSE021443R1
TU844	Module Termination Unit, MTU, for redundant applications, 50V. Used with AI845, AI880 and DP840. Horizontal mounted DIN rail. Rated isolation 50V. Shunt Stick not included.	3BSE021445R1
TU845	Module Termination Unit, MTU, for redundant applications, 50V. Used with AI845, AI880A and DP840. Vertical mounted DIN rail. Rated isolation 50V. Shunt Stick not included.	3BSE021447R1
TU850	Extended Module Termination Unit, MTU, 50V 2x8 signal terminals and 2x8 disconnectable current limited sensor/transmitter outlet power terminals. Rated isolation 50V.	3BSE050930R1
TU851	Extended Module Termination Unit, MTU, 250V 2x16 signal terminals, Rated isolation 250V	3BSE068782R1

Name	Short Description	Article No.
TU852	Module Termination Unit, MTU, for redundant applications, 50V Horizontal mounted DIN rail, used with redundant AO, DI, DO and DP I/O modules, with 2x25 pin D-sub connector, Rated isolation 50V	3BSE069964R1
TU854	Module Termination Unit, MTU, for redundant applications, 50V Horizontal mounted DIN rail, used with redundant AI and DP I/O modules, with 1x25 pin D-sub connector, Rated isolation 50V, Shunt Stick not included	3BSE069966R1
TU890	Module Termination Unit for Intrinsic Safety applications 3x9 signal terminals Rated isol. 50V. Including wiring separator.	3BSC690075R1
TU891	Module Termination Unit for non Intrinsic Safety applications 3x9 signal terminals Rated isol. 50V.	3BSC840157R1
TY801K01	8pcs Shunt Stick TY801 125 + 125 Ohm shunt. Used for AI845 and AI880A on TU844, TU845, TU854	3BSE023607R1
TY804K01	8pcs Shunt Stick TY804 1000 Ohm shunt. Used for DP840 on TU844, TU845, TU854	3BSE033670R1
TY820K01	10pcs Temperature Sensor TY820 TY820 is a temperature sensor with a PT 100 element. Can be used with AI835/AI835A and AI843 to measure cold junction Temperature.	3BSE056980R1



## 5.3.3 S800L (eA) modules

### 5.3.3.1 S800L (eA) Analog input modules

Name	Short Description	Article No.
AI801-eA	Analog Input, 1x8 channels 0(4)..20 mA, 12 bit, single ended, 0.1%, Rated isolation 50 V.	3BSE020512R2

### 5.3.3.2 S800L (eA) Analog output modules

Name	Short Description	Article No.
AO801-eA	Analog Output, 1x8 channels 0(4)..20 mA, 12 bit, RLmax 850 Ohm, Rated isolation 50 V.	3BSE020514R2

### 5.3.3.3 S800L (eA) Digital input modules

Name	Short Description	Article No.
DI801-eA	Digital Input, 24 VDC, 1x16 channels Rated isolation 50 V.	3BSE020508R2
DI802-eA	Digital Input, 120 VAC / DC, 8x1 channel Rated isolation 250 V.	3BSE022360R2
DI803-eA	Digital Input, 230 VAC / DC, 8x1 channel Rated isolation 250 V.	3BSE022362R2

### 5.3.3.4 S800L (eA) Digital output modules

Name	Short Description	Article No.
DO801-eA	Digital Output, 24 VDC, 16 channels 0.5 A. Short circuit proof, Rated isolation 50 V.	3BSE020510R2
DO802-eA	Digital Output, Relay, normal open, 8x1 channel 24-230 V, AC Rated isolation 250 V.	3BSE022364R2

### 5.3.3.5 Label sets for S800L I/O modules

Name	Short Description	Article No.
Label Set S800L	16 channels Sheet with 12 labels for 16 channels I/O modules.	3BSE019419R1
Label Set S800L	8 channels Sheet with 12 labels for 8 channels I/O modules.	3BSE019419R2

### 5.3.3.6 S800L ModuleBus communication parts

Name	Short Description	Article No.
TB805	Bus Outlet	3BSE008534R1
	ModuleBus extension cable adaptor D-sub 25, female. One required per extension cable TK801.	
TB845	Dual ModuleBus outlet	3BSE021437R1
	ModuleBus extension cable adaptor two D-sub, female. Two TK801 cables for redundancy.	
TB806	Bus Inlet	3BSE008536R1
	ModuleBus extension cable adaptor D-sub 25, male. One required per extension cable TK801.	
TB846	Dual ModuleBus inlet	3BSE021439R1
	ModuleBus extension cable adaptor two D-sub, male. Two TK801 cables for redundancy.	
TK801V003	TK801V003 Cable	3BSC950089R1
	ModuleBus Extension Shielded Cable 0.3m D-sub 25, male-female. G3 compliant.	
TK801V006	TK801V006 Cable	3BSC950089R2
	ModuleBus Extension Shielded Cable 0.6m D-sub 25, male-female. G3 compliant.	
TK801V012	TK801V012 Cable	3BSC950089R3
	ModuleBus Extension Shielded Cable 1.2m D-sub 25, male-female. G3 compliant.	
TB807	ModuleBus terminator	3BSE008538R1
	G3 compliant.	
TB820V2	ModuleBus Cluster Modem	3BSE013208R2
	Optical cluster modem for non redundant operation. Including: 1x Power Supply Connector 1x TB807 ModuleBus Terminator.	
TB840A	ModuleBus Cluster Modem	3BSE037760R2
	Optical cluster modem for 1+1 redundant operation.	
TB842	ModuleBus Optical Port	3BSE022464R1
	Used together with CI801 and CI840, connected via TB806 or TB846. 10 Mbits driver.	
TU807	Termination Unit for TB840/TB840A	3BSE039025R1
	Support for single modulebus I/O. Including: 1 pcs TB807	
TU840	Termination Unit for 1+1 TB840. Support for redundant I/O	3BSE020846R1
	Including: 1 pcs Power Supply Connector 2 pcs TB807 Modulebus Terminator	

Name	Short Description	Article No.
TU841	Termination unit for 1+1 TB840. Support for non-redundant I/O  Including: 1 pcs Power Supply Connector 1 pcs TB807 Modulebus Terminator	3BSE020848R1
TU848	MTU with individual power supply for red. TB840/TB840A. Support for dual modulebus.  Including: 2 pcs TB807	3BSE042558R1
TU849	MTU with individual power supply for red. TB840/TB840A. Support for single modulebus  Including: 1 pcs TB807	3BSE042560R1
TK811V015	POF Cable, 1.5 m, Duplex  L = 1.5 m latching duplex connector Duplex plastic fibre.	3BSC950107R1
TK811V050	POF Cable, 5 m, Duplex  L = 5 m latching duplex connector Duplex plastic fibre.	3BSC950107R2
TK811V150	POF Cable, 15 m, Duplex  L = 15 m latching duplex connector Duplex plastic fibre.	3BSC950107R3
TK812V015	POF Cable, 1.5 m, Simplex  L = 1.5 m latching connector Simplex plastic fibre.	3BSC950118R1
TK812V050	POF Cable, 5 m, Simplex  L = 5.0 m latching connector Simplex plastic fibre.	3BSC950118R2
TK812V150	POF Cable, 15 m, Simplex  L = 15 m latching connector Simplex plastic fibre.	3BSC950118R3

### 5.3.4 Power supplies

Name	Short Description	Article No.
SD822Z	Power Supply Device  Input 115/230V a.c. switch selectable, output 24V d.c., 5A. If redundant power application is required connect to SS822Z Voting Unit. Width=65mm. DIN rail mounted.	3BSC610054R1
SS822Z	Power Voting Unit  With dual 24V d.c 20A inputs, single 24V d.c. 20A output. Each power input supervised. Used if redundant power supply is required. For use with power supply SD822Z. Width=50mm. DIN rail mounted.	3BSC610055R1
SD831	Power Supply Device  Input 100-240 VAC or 110-300 VDC. Output 24 VDC, 3 A. If redundant power application is required connect to SS8XX Voting unit. Width = 35 mm. DIN rail mounted.	3BSC610064R1
SD832	Power Supply Device  Input 100-120 / 200-240 VAC. Output 24 VDC, 5 A, auto-select input. If redundant power application is required connect to SD8XX Voting unit. Width = 35 mm. DIN rail mounted.	3BSC610065R1

Name	Short Description	Article No.
SD833	Power Supply Device	3BSC610066R1
	Input 100-120 / 200-240 VAC, auto-select input. Output 24 VDC, 10 A. If redundant power application is required connect to SD8XX Voting unit. Width = 60 mm. DIN rail mounted.	
SD834	Power Supply Device	3BSC610067R1
	Input 100-240 VAC or 110-300 VDC. Output 24 VDC, 20 A. If redundant power application is required connect to SS8XX Voting unit. Width = 85 mm. DIN rail mounted.	
SS832	Voting Device	3BSC610068R1
	Input 24 VDC. Dual 24 V to single 24 V, 2x 10 A. Width = 35 mm. DIN rail mounted.	

### 5.3.5 S800 I/O user documentation

Name	Short Description	Article No.
S800 I/O	Getting Started	3BSE020923-510
	User's Guide.	
S800 I/O	Modules and Termination Units	3BSE020924-510
	User's Guide.	
S800 I/O	Fieldbus Communication Interface for PROFIBUS DP/DPV1	3BSE020926-510
	User's Guide.	
S800 I/O	Modules and Termination Units with Intrinsic Safety Interface	3BSE020927-510
	User's Guide.	
S800 I/O	DTM 5.3	3BSE027630-510
	Reference Manual.	
S800 I/O	CI840 Memory Maps	3BSE025251-510
	Reference Manual.	
S800 I/O	CI801 Memory Maps	3BSE036959R5021
	Reference Manual.	

## 5.4 S900 Remote I/O



### 5.4.1 Introduction to S900 I/O system

S900 provides the input and output modules needed for intrinsically safe field signal connection. The field signals are digitized in every S900 functional module, electrically isolated, and then output via an internal serial bus. The communication interface converts the signals to adapt them to the standardized PROFIBUS-DP V1 fieldbus protocol.

Supervisory process control systems, DCS or SCADA systems use an intrinsically safe fieldbus to communicate with the communication interface. A Profibus connect allows the configuration of the individual S900 stations with cyclic data exchange, acyclic services and communication with HART-compatible field instruments. All functional modules can be replaced easily and quickly, which is an advantage especially in the installation or maintenance phase in hazardous area. The functional modules and the – optionally redundant – communication interface modules placed in Zone 1 can be removed and plugged in while operation is running.

Integrated encapsulated switch-off mechanisms allow for hot swapping of the power supplies. Due to its little space requirements and robust design and its environmentally ruggedized case, the S900 Remote I/O System is a cost-saving solution for use on site, in hazardous Zone 1 or Zone 2 areas (ATEX).

#### No external signal adaptation or routing required

S900 provides various input and output modules: Analog input modules with or without integral transmitter supply, or with direct temperature measuring input for 2-, 3- or 4-wire resistance thermometers or thermocouples with internal cold junction compensation. Analog output modules for direct positioner or actuator control. Solenoid driver units or NAMUR inputs for intrinsically safe and short-circuit-proof power supply of digital field instruments.

Additionally, options are available for critical applications, allowing for channel-wise electrical isolation of the inputs and outputs. S900 permits direct connection of the entire field level through only 2 lines. As no separate routing, power supply or fusing is needed, the installation cost is reduced considerably.

Three different series with different use and with different approvals are available.

Series	Assembly	Field devices / signals	Hazardous area approval
S	in Zone 1	in Zones 2, 1, and 0 (intrinsically safe signals)	ATEX Zone 1
B	in Zone 2	in Zones 2, 1, and 0 (intrinsically safe signals)	ATEX Zone 2
N	in safe areas	in safe areas	no

For details about S900 I/O please refer to the S900 catalog, document number 3BDD010420.

## 5.4.2 Redundant termination unit TU921S/B/N

- Termination unit for up to 16 I/O modules
- Prepared for redundant system power and communication
- Up to 4 terminals per channel
- Preselection of fieldbus address
- Prepared for certified field housing
- Mounting in Zone 1 or Zone 2 possible

Name	Short Description	Article No.
TU921S	Redundant Termination Unit (TU16R-Ex) For 16 I/O-modules. Redundant communication and power. (Delivery includes CD910).	3KDE175111L9210
TU921B	Redundant Termination Unit (TU16R-B) For 16 I/O-modules. Redundant communication and power. (Delivery includes CD910).	3KDE175112L9210
TU921N	Redundant Termination Unit (TU16R) For 16 I/O-modules. Redundant communication and power. (Delivery includes CD910).	3KDE175113L9210

## 5.4.3 Power supply SA920S/B/N



- Powering of communication interfaces and I/O modules
- Hot swap capability (SA920S in Zone 1, SA920B in Zone 2)
- Redundant powering
- Alarm in case of power failure (with redundancy)
- Switching On by tighten the 4 switch-on interlock screws (only SA920B and SA920S)

Name	Short Description	Article No.
SA920S	Power Supply For 24 VDC. The power supply filter type BP901S is not required.  Do not mix SA910S with SA920S for redundancy (observe Release Notes).	3BDH000602R1
SA920B	Power Supply For 24 VDC. The power supply filter type BP901S is not required. SA920B is the functional replacement for SA910B  Do not mix SA910B with SA920B for redundancy (observe Release Notes).	3BDH000601R1
SA920N	Power Supply For 24 VDC. The power supply filter type BP901S is not required. SA920N is the functional replacement for SA910N  Do not mix SA910N with SA920N for redundancy (observe Release Notes).	3BDH000600R1





## 5.4.4 Digital I/O modules

### Digital I/O modules DX910S/B/N

- Input for dry contacts or proximity switches (NAMUR)
- Output for low power intrinsically safe valves
- Short and break detection
- Electrical isolation between input / bus and input / power
- Common return for all inputs / outputs
- Configurable as a mixture of inputs and outputs
- 8 I/O channel

Name	Short Description	Article No.
DX910S	Digital Input or Output (DIO8-Ex)	3KDE175311L9100
	Input for dry contact or NAMUR initiator. Output for low power intrinsic safe valves.	
DX910B	Digital Input or Output (DIO8-B)	3KDE175312L9100
	Input for dry contact or NAMUR initiator. Output for low power intrinsic safe valves.	
DX910N	Digital Input or Output (DIO8)	3KDE175313L9100
	Input for dry contact or NAMUR initiator. Output for low power valves.	



### Solenoid driver DO910S/B/N

- Output for intrinsically safe valves or alarms
- Integrated driving power
- Short and break detection
- Electrical isolation between output / bus and output / power
- Electrical isolation channel to channel
- 4 channels

Name	Short Description	Article No.
DO910S	Digital Output (DO4-Ex)	3KDE175321L9100
	Output for intrinsic safe valves.	
DO910B	Digital Output (DO4-B)	3KDE175322L9100
	Output for intrinsic safe valves.	
DO910N	Digital Output (DO4)	3KDE175323L9100
	Output for valves.	



## Frequency input DP910S/B/N

- Frequency input for dry contacts or proximity switches
- Short and break detection
- Electrical isolation between input / bus and input / power
- Frequency measurement or counting applications
- 2 Function blocks
- Reset via fieldbus or control input
- Status outputs / Direction recognition

Name	Short Description	Article No.
DP910S	Frequency Input (FI2-Ex)	3KDE175361L9100
	Input for dry contact or NAMUR initiator.	
DP910B	Frequency Input (FI2-B)	3KDE175362L9100
	Input for dry contact or NAMUR initiator.	
DP910N	Frequency Input (FI2)	3KDE175363L9100
	Input for dry contact or NAMUR initiator.	



## 5.4.5 Analog I/O modules

### Analog input AI910S/B/N

- Power supply for 4...20 mA loop powered 2-wire transmitters
- Short and break detection
- Electrical isolation between input / bus and input / power
- Common return for all inputs
- 4 channels

Name	Short Description	Article No.
AI910S	Analog Input (AI4-Ex)	3KDE175511L9100
	Transmitter power supply, 4..20 mA.	
AI910B	Analog Input (AI4-B)	3KDE175512L9100
	Transmitter power supply, 4..20 mA.	
AI910N	Analog Input (AI4)	3KDE175513L9100
	Transmitter power supply, 4..20 mA.	



## Analog input, HART, AI930S/B/N

- Power supply for 4...20 mA loop powered 2-wire transmitters
- Short and break detection
- Electrical isolation between input / bus and input / power
- Common return for all inputs
- 4 channels
- Transmission of HART frames via the fieldbus
- Cyclic HART variables

Name	Short Description	Article No.
AI930S	Analog Input, HART (AI4H-Ex)	3KDE175511L9300
	Transmitter power supply, 4..20 mA.	
AI930B	Analog Input, HART (AI4H-B)	3KDE175512L9300
	Transmitter power supply, 4..20 mA.	
AI930N	Analog Input, HART (AI4H)	3KDE175513L9300
	Transmitter power supply, 4..20 mA.	



## Analog input, HART, passive, AI931S/B/N

- Passive inputs for 0/4...20 mA
- Short and break detection
- Electrical isolation between input / bus and input / power
- Common return for all inputs
- 4 channels
- Transmission of HART frames via the fieldbus
- Cyclic HART variables

Name	Short Description	Article No.
AI931S	Analog Input, HART (AI4H-Ex)	3KDE175511L9310
	Passive input, 0/4..20 mA.	
AI931B	Analog Input, HART (AI4H-B)	3KDE175512L9310
	Passive input, 0/4..20 mA.	
AI931N	Analog Input, HART (AI4H)	3KDE175513L9310
	Passive input, 0/4..20 mA.	



## Temperature input AI950S/B/N

- Pt 100, Pt 1000, Ni 100, 0...3 kOhm in 2-/3-/4-wire technique
- Thermocouple Type B, E, J, K, L, N, R, S, T, U, mV
- Internal or external cold junction compensation
- Short and break detection
- Electrical isolation between input / bus and input / power
- Electrical isolation channel to channel
- 4 channels

Name	Short Description	Article No.
AI950S	Temperature (TI4-Ex)	3KDE175521L9500
	Pt100, Pt1000, Ni100 in 2-/3-/4-wire technique thermocouples type B, E, J, K, L, N, R, S, T isolated inputs channel by channel.	
AI950B	Temperature (TI4-B)	3KDE175522L9500
	Pt100, Pt1000, Ni100 in 2-/3-/4-wire technique thermocouples type B, E, J, K, L, N, R, S, T isolated inputs channel by channel.	
AI950N	Temperature (TI4)	3KDE175523L9500
	Pt100, Pt1000, Ni100 in 2-/3-/4-wire technique thermocouples type B, E, J, K, L, N, R, S, T isolated inputs channel by channel.	

5



## Analog output AO910S/B/N

- Output signal 0/4...20 mA for actuators
- Short and break detection
- Electrical isolation between output / bus and output / power
- Output with common ground
- 4 channels

Name	Short Description	Article No.
AO910S	Analog Output (AO4-Ex)	3KDE175531L9100
	Output 0/4..20 mA.	
AO910B	Analog Output (AO4-B)	3KDE175532L9100
	Output 0/4..20 mA.	
AO910N	Analog Output (AO4)	3KDE175533L9100
	Output 0/4..20 mA.	



## Analog output, isolated AO920S/B/N

- Output signal 0/4...20 mA for actuators
- Short and break detection
- Electrical isolation between output / bus and output / power
- Electrical isolation channel to channel
- 4 channels

Name	Short Description	Article No.
AO920S	Analog Output, isolated (AO4I-Ex)	3KDE175531L9200
	Output 0/4...20 mA. Isolated outputs channel by channel.	
AO920B	Analog Output, isolated (AO4I-B)	3KDE175532L9200
	Output 0/4...20 mA. Isolated outputs channel by channel.	
AO920N	Analog Output, isolated (AO4I)	3KDE175533L9200
	Output 0/4...20 mA. Isolated outputs channel by channel.	



## Analog output, HART, AO930S/B/N

- Output signal 0/4...20 mA for actuators
- Short and break detection
- Electrical isolation between output / bus and output / power
- Output with common ground
- 4 channels
- Transmission of HART frames via the fieldbus
- Cyclic HART variables

Name	Short Description	Article No.
AO930S	Analog Output, HART (AO4H-Ex)	3KDE175531L9300
	Output 0/4...20 mA.	
AO930B	Analog Output, HART (AO4H-B)	3KDE175532L9300
	Output 0/4...20 mA.	
AO930N	Analog Output, HART (AO4H)	3KDE175533L9300
	Output 0/4...20 mA.	



## 5.4.6 Field housing

### Field housing FH660S, FH680S

Stainless steel field housing for extended termination unit

- Prepared for wall mounting
- Mounting in Zone 1 or Zone 2

Name	Short Description	Article No.
FH660S - 2000	Field housing Including the following components: Termination Unit TU921S and 4 Terminals UK10N	3KDE175804V2000
FH660S - 2020	Field housing Including the following components: Termination Unit TU921S, 4 Terminals UK10N and 2 Switches	3KDE175804V2020
FH680S - 2020	Field housing Including the following components: Termination Unit TU921S, 4 Terminals UK10N and 2 Switches	3KDE175811V2020

### Field Housing roof

Name	Short Description	Article No.
S900 - BI100	Field Housing roof Weather protection. Fits to all field housing.	3KDE175831L1000



## Compact box CB220N

- Field housing for power supply and communication interface
- Mounting of max. 4 I/O modules
- Preselection of fieldbus address (0 ... 99)
- Separation of function level and wiring level
- Mounting in safe area

Name	Short Description	Article No.
CB220N	Compact-Box	3KDE175613L2210
	For power supply SA911N, communication interface CI920AN and four I/O modules S900 type N (Delivery includes CD910).	



## Power supply SA911N for CB220N

- Powering of communication interfaces and I/O modules
- Hot swap capability

Name	Short Description	Article No.
SA911N	Power supply for CB220N	3KDE175613L9110
	For 24 VDC.	

illustration similar

## 5.4.7 Accessories for S900

### Fieldbus isolating repeater

Name	Short Description	Article No.
BI914S	Fieldbus isolating repeater  separates one intrinsically safe RS485 fieldbus segment from a non intrinsically safe RS485 fieldbus with bus termination BARTEC - 07-7311-97WP/K1E0 DIN rail housing with IP20 protection	3BDH000649R1

### Ring-coupler

Name	Short Description	Article No.
BI923S	Ring-coupler RS485 / FO - intrinsically safe - Slave  Separates an intrinsically safe fibre optic ring from a non intrinsically safe RS485 interface BARTEC - 07-7311-97WP5400 integrated in DIN rail mounted housing with IP20 protection Optical Plug FSMA (Slave)	3KDE175831L9230
BI924S	Ring-coupler RS485 / FO intrinsically safe - Master  Separates an intrinsically safe fibre optic ring from a non intrinsically safe RS485 interface BARTEC - 07-7311-97WP5400 integrated in DIN rail mounted housing with IP20 protection Optical Plug FSMA (Master)	3KDE175831L9240
BI934S	Ring-coupler RS485 / FO intrinsically safe (slave)  separates an intrinsically safe fibre optic ring from one intrinsically RS485 fieldbus segment integrated in separate field housing BARTEC - 07-3103-2512/9003 Optical Plug FSMA	3BDH000674R0001

### Additional accessories

Name	Short Description	Article No.
IP920	Module housing  IP20 protection for empty slots on the termination unit. For use in S900 S, B, and N systems.	3KDE175831L9200
IL910	Insert labels  380 pcs.	3KDE175839L9101
BP914S	Intrinsically safe PROFIBUS-DP connector for CI920AS and CI920AB  D-SUB Connector (color blue) for operating the intrinsically safe PROFIBUS-DP with CI920AS and CI920AB (Siemens 6ES7972-0DA60-0XA0)	3BSE067082R1



## 5.4.8 Software

Name	Short Description	Article No.
CD910	Additional Software CD ROM incl. S900 Documentation, Certificates, GSD (file) ABB DTM S900 DP and Software Tools CD ROM will be delivered with all TU921 and CB220 deliveries	3KDE175839L9100



# Chapter 6 – Fieldbus network components and Profibus configuration for S700

- 6.1 Profibus DP configuration for S700 . . . . .154
- 6.2 PROFIBUS network components . . . . .156
- 6.3 FOUNDATION Fieldbus network components . . 156

## 6.1 Profibus DP configuration for S700 I/O

When the Freelance controllers are equipped with the appropriate Profibus Master module they can communicate over a single Profibus DP segment with several remote I/O stations. Some configurations are shown in the following figures. They describe different ways how to feed the PDP22-FBP fieldbus plug, which is an active element, with power.

**Please note:** A new fieldbus interface module (CI 741F) for S700 will soon be available replacing DC 705F FBP interface module. Then a standard Profibus plug can be used and you do not need the Fieldbus Plug any longer.

Figure 13 shows the first variant, where the power is fed in with the PDA11 adapter cable. The twisted-pair cable has to be connected to an 24 V DC power supply. The M12 connector of the cable is directly connected close to the controller using the fieldbus plug. The adapter cable has four wires, two more than a standard Profibus cable. The additional wires are used to feed the external power to both fieldbus plugs shown in Figure 13.

The Profibus DP segment has to be terminated with a PDR11-FBP terminator.

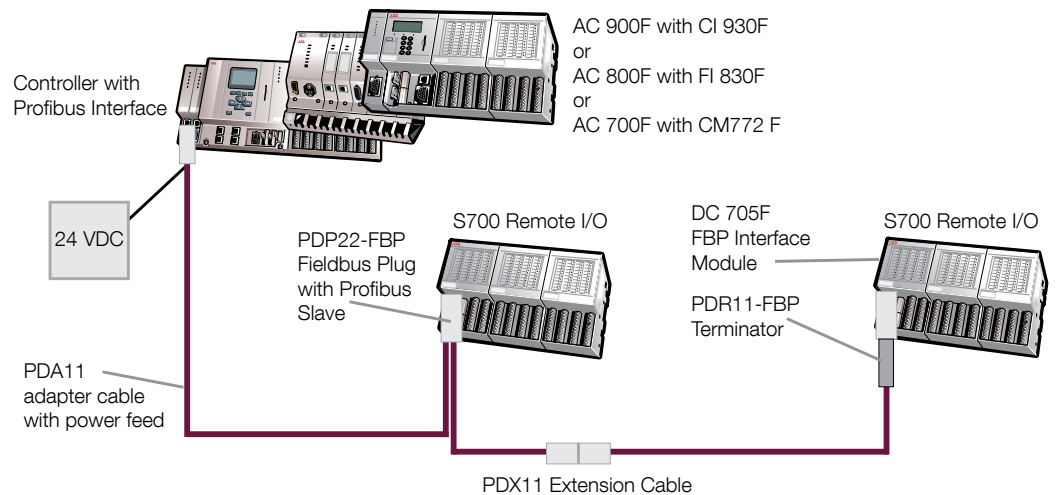

Figure 13: Profibus configuration with AC 900F, AC 800F or AC 700F, S700 remote I/O and PDA11 adapter cable

Another variant to feed the fieldbus plug with power is shown in Figure 14. In this case a standard Profibus cable (D-Sub9 - M12) is used instead of PDA11. To supply the power, a feed-in connector of type PDV11 or PDV12 is used. The cable of the fieldbus plug is connected close to the remote I/O feed-in connector.

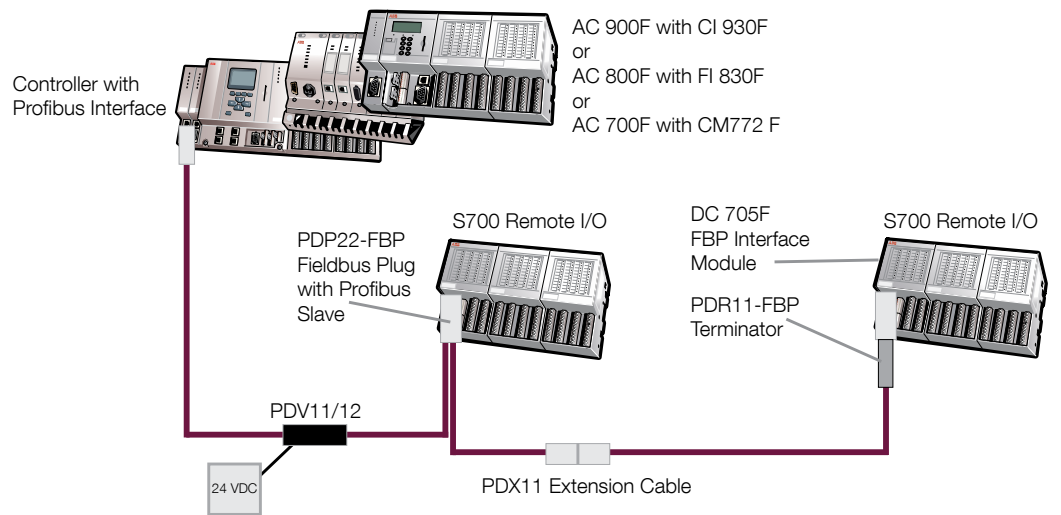

Figure 14: Profibus configuration with AC 900F, AC 800F or AC 700F, S700 remote I/O and power feed-in connector

Figure 15 shows a Profibus configuration where two different types of remote I/O stations are connected to a Freelance controller. Standard cables are used to connect the S900 station. The power for the fieldbus plug will be again fed by a PDV11 or PDV12 feed-in connector.

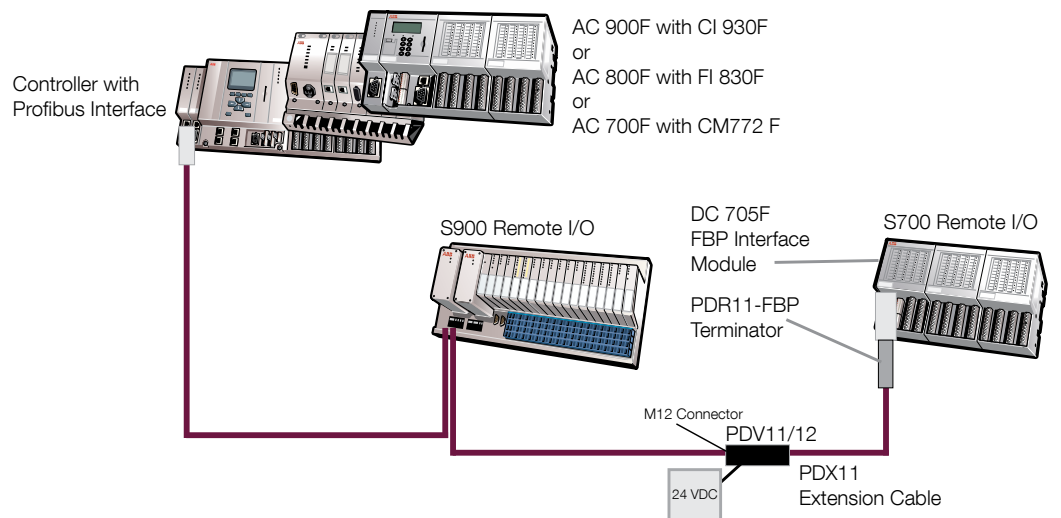

Figure 15: Profibus configuration with S900 and S700 remote I/O; and power feed-in connector

## 6.2 PROFIBUS network components



Name	Short Description	Article No.
RLM01	<p>PROFIBUS Redundancy Link Module for PROFIBUS line redundancy</p> <p>Converts a non-redundant PROFIBUS line to two redundant RS485 lines or vice versa.</p> <p>Germanischer Lloyd (GL) certified (cat. A,B,C,D) in connection with power supply filter (3BDZ000397R1).</p>	3BDZ000398R1
Power Supply Filter	<p>Power Supply Filter (surge) 24 VDC</p> <p>Mandatory to fulfill the requirements of Germanischer Lloyd (GL).</p>	3BDZ000397R1
PCO 010	<p>PROFIBUS DP connector, standard</p> <p>Max. 12 Mbit/s, 35° cable outlet, IP40, without bus termination.</p>	3BDZ000370R1
PCO 011	<p>PROFIBUS DP connector with bus termination</p> <p>Max. 12 Mbit/s, 35° cable outlet, IP40, switchable bus termination.</p>	3BDZ000371R1
PCO 012	<p>PROFIBUS DP connector with bus termination and adapter</p> <p>Max. 12 Mbit/s, 35° cable outlet, IP40, switchable bus termination, programming connection SUB-D.</p>	3BDZ000372R1

6

## 6.3 FOUNDATION Fieldbus network components



LD 800HSE



LD 800HSE EX

Name	Short Description	Article No.
LD 800HSE	<p>Linking Device LD 800HSE</p> <p>LD 800HSE module for DIN rail mounting with 4 H1 links and one HSE connector.</p> <p>The module itself needs external 24 VDC power supply. H1 links must be powered separately.</p>	3BDH000320R02
LD 800HSE EX	<p>Linking Device LD 800HSE EX</p> <p>LD 800HSE module for DIN rail mounting with 4 H1 links and one HSE connector. Certified for hazardous area Zone 2 acc. to ATEX and IECEx (observe Release Notes).</p> <p>The module itself needs external 24 VDC power supply. H1 links must be powered separately.</p>	3BSE073314R1
Redundancy Link Cable	<p>Redundancy Link Cable, 0.5 m</p> <p>Redundancy Link Cable links two LD 800HSE to a redundant set of devices.</p>	3BDH000281R1
Media CD LD 800HSE	<p>Version 3.5.0, English</p> <p>Documentation in pdf-format, tools, capabilities file, and bitmaps for LD 800HSE.</p>	3BDD011678R0701
Media CD LD 800HSE and LD 800HSE EX	<p>Version 3.6.0, English</p> <p>Documentation in pdf-format, tools, capabilities file, and bitmaps for LD 800HSE and LD 800HSE EX</p>	3BDD011678R0801

Name	Short Description	Article No.
Printed User Instructions LD 800HSE	Version 3.5.0, English  Describes in detail the FOUNDATION Fieldbus Linking Device LD 800HSE features, hardware installation, configuration and diagnostics.	3BDD011677R0701
Printed User Instructions LD 800HSE and LD 800HSE EX	Version 3.6.0, English  Describes in detail the FOUNDATION Fieldbus Linking Device LD 800HSE / LD 800HSE EX features, hardware installation, configuration and diagnostics.	3BDD011677-600





# Chapter 7 – Freelance Operations

7.1 Overview .....	160
7.2 Messages & operator hints .....	164
7.3 Automation Sentinel.....	166
7.4 Freelance Software languages.....	166
7.5 Freelance Operations license .....	166
7.6 Connectivity.....	167
7.7 Freelance Operations options .....	167
7.8 Freelance Operations hardkeys .....	167

## 7.1 Overview

Freelance Operations, based on Microsoft Windows as a graphical user interface, enhances the ease of use and the performance of process operation. In addition, you can also use any PC peripherals such as monitors, printers, mice and keyboards that are available on the market for Windows compliant PCs. The Freelance Operations software supports both the conventional screen formats 4:3 / 5:4 and the wide-screen formats 16:9 / 16:10.

The operation and engineering functions can also be performed together on one PC. Freelance Operations offers the following features:

- Transparent and rapid operation due to a clearly structured information hierarchy
- User-specific function key assignment for fast display selection
- A large number of pre-engineered displays
- Rapid and secure action in case of process alarms
- Trend displays with archiving
- Logging of all operator actions, including name and time-stamp
- System diagnostics, even down to the field device, allowing extended field device diagnostics

- Uniform process alarm and message concept and clearly arranged display of messages and operator hints
- Up to 16 user groups / access profiles, with up to 1000 users, specific password for each user (with optional Security Lock software)
- Various language versions: English, Chinese, German, Spanish, Brazilian Portuguese, Swedish, Russian, Polish, French, and Japanese
- A control aspect, providing access to automatically generated dynamic interlocking displays for the selected tag (in connection with OPC or trend server)
- External aspects, providing access to additional information such as PDF documentation, live videos from the plant, standard operational procedures (SOPs), etc.
- Configurable voice output on the PC for process alarms
- Dual-monitor operation on a single PC, with one mouse and one keyboard

The process visualization is supported by plant-specific custom graphic displays, faceplates for tags and up to 15 plant areas with plain text labeling.

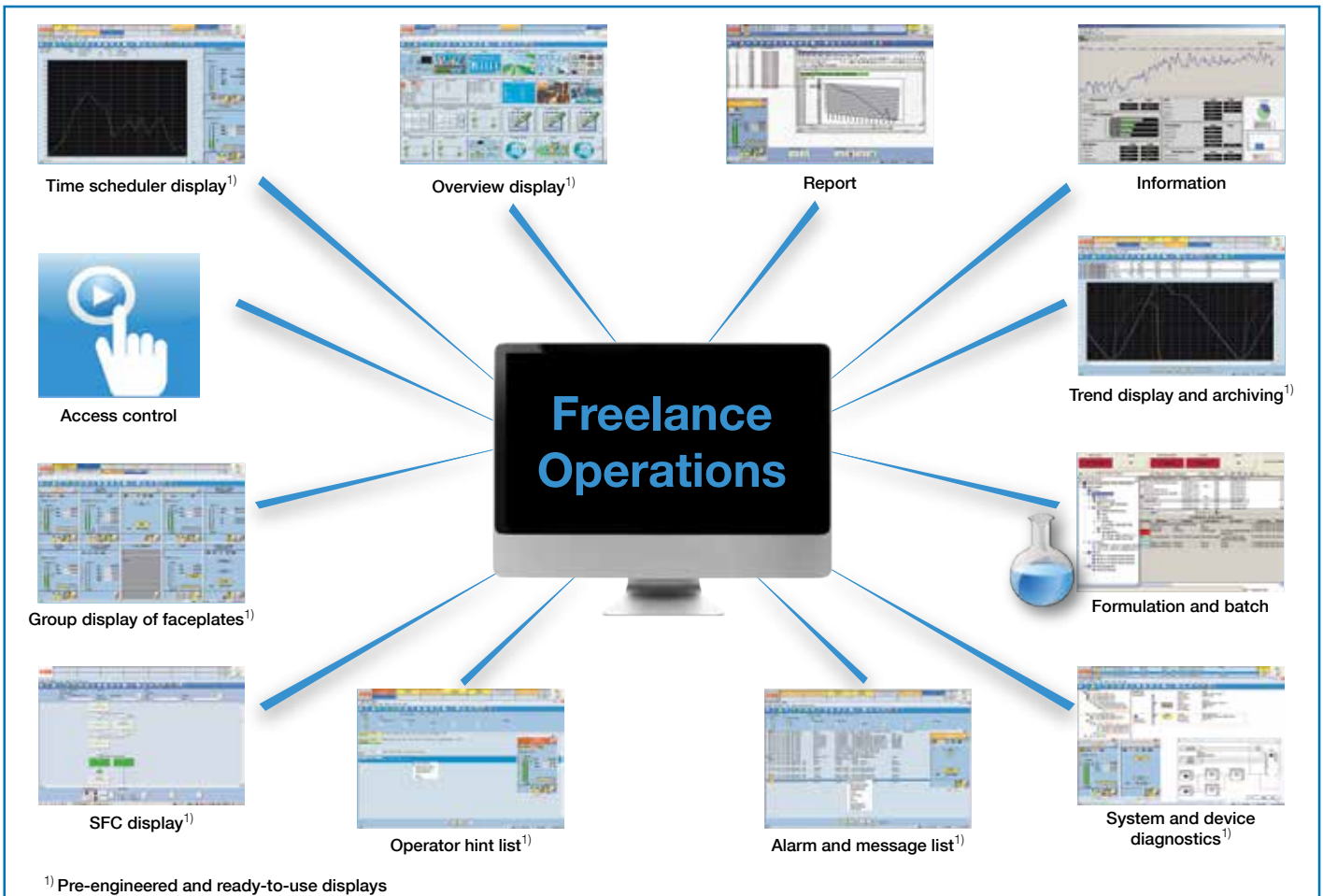

## Plant-specific displays

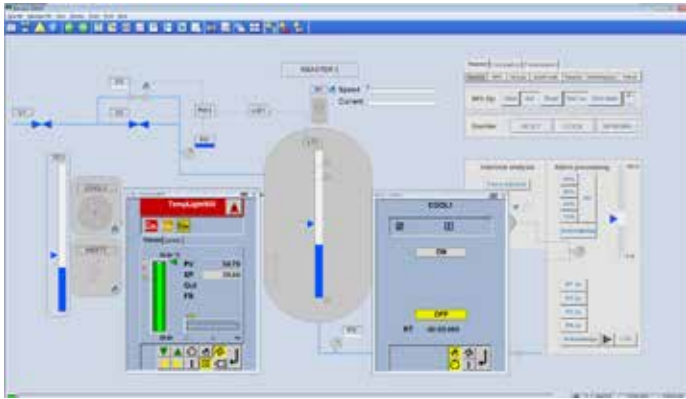

Figure 16: Graphic display with faceplates

Plant-specific displays geared to the specific demands of the plant operator can be configured to depict process activities.

Static sections of the graphic displays can be created using the graphics editor. In addition, you also have the option of inserting such static sections in the form of bitmaps, created by any other graphic editor, scanner, or digital photograph. Current process data or process states can be animated at every suitable position using features such as bar graphs, level indicators and trend windows.

Depending on process states, graphic symbols can, flash, change color and position or be replaced in the graphic display. Tags can be viewed either via faceplates in the graphic displays or via the standard group displays.

Display selector fields or buttons can be used to setup a specific selection hierarchy within custom graphics for operation. The number of custom graphics available in Freelance Operations is limited only by the hard disk capacity.

## Pre-engineered, ready-to-use displays

Pre-engineered displays are adapted to the needs of process control engineering with regard to structure and information content.

The following displays are available:

- Overview display
- Group display
- Faceplate
- Sequential Function Cart (SFC) display
- Time scheduler display
- Trend display
- Web display
- Message list and operator hint list
- Logs
- System display for hardware diagnostics

Therefore, most functions already have fully prepared displays for operation and observation, and can be used without additional work.

## Overview display

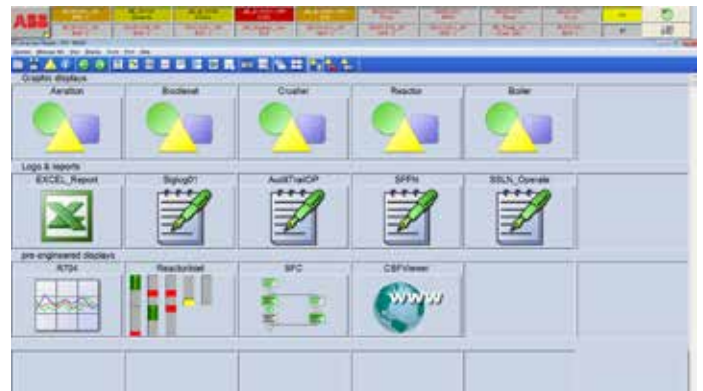

Figure 17: Overview display

The process information for the entire plant is presented in a condensed manner in a single overview display. It offers facilities for selecting the group, graphic, SFC, Web, time scheduler and trend displays. Logs can also be called up directly from the overview display. Up to 96 displays can be shown in the overview display. The group display symbols within the overview display also feature dynamic updating of tags, allowing disturbance states to be detected rapidly through appropriate symbols and colors. If required, you can also set a graphic display of your choice as overview display. It then replaces the standardized display.

## Faceplates



Faceplates

Faceplates allow both overview and detailed information to be obtained simultaneously. Since faceplates are predefined, they are available immediately in the system following the definition of a tag, without any additional programming. This is also the case for user-defined faceplates. Therefore, faceplates can be displayed together with standardized and freely designed displays.

## 7 Group display



Figure 18: Group display

The group display is a combination of several faceplates and contains detailed information about associated tags. All functions, including controllers, PID-loops, time and monitoring functions as well as open-loop control functions, can be displayed and operated.

To provide a quick source of information, analog values are displayed as colored bars. To allow more precise reading, they are also shown as alphanumeric values. Pending disturbance states in the respective variables can be detected immediately through a change in color and flashing, and can be acknowledged directly in the faceplate or message list. Configured limits can be additionally displayed as symbols. You can create your own faceplates for user-defined function blocks.

## SFC display



SFC Display

The sequential function chart (SFC) based on the IEC 61131-3 standard is viewed in a standardized SFC display showing the current program state of the sequential function chart. In the SFC display, you see the actual processing status, where already finished and coming steps are marked with different colors. Disturbance states, such as non-fulfilled process criteria or time outs can be easily detected by a color change within a criteria window for steps and transitions.

Furthermore, a display selection can be configured for each step and transition. The variables shown in the criteria window can be operated.

An SFC overview display allows direct access to a step or transition, and the desired information can be selected immediately. This is particularly beneficial in the case of complex open-loop control structures, when rapid intervention by the operator is essential. The Control Aspect allows the animated display of the transition program, similar to the commissioning display in Freelance Engineering.

The display is generated automatically and is an alternative to the criteria window, which allows you to configure a standardized, reduced display of the criterias.

## Time scheduler display

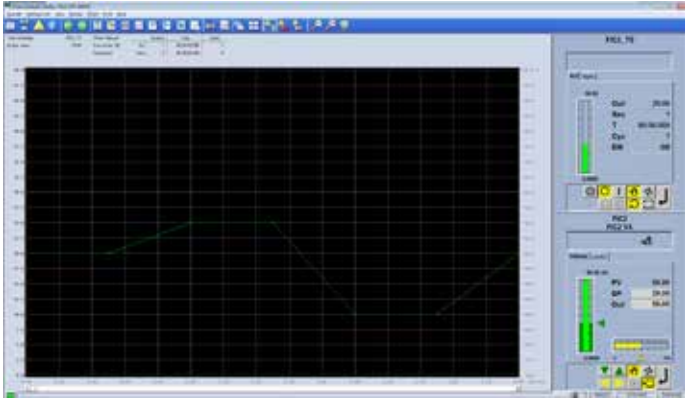

Time Scheduler Display

The time scheduler module makes it possible to define analog variables during a pre-defined time by default, e.g. as a set point value for a connected controller. The current set point is determined from a series of up to 32 configured values describing a set point curve. The time scheduler display is easy to operate. Apart from enabling the switching of operation modes, it also permits the modification of the current set point. Manual alterations to the set point are displayed in a separate curve.

A manual set point can be defined by offsetting the configured set point. A return (time-delayed) to the original value is possible at any time. A program can be executed cyclically or by stating a certain number of runs.

## Web display

The Web display provides a simple way to display web pages on the operator station, without covering the message line. For example, this allows you to observe the picture of a camera using a built-in Web server, making it easy to monitor flames or observe chimneys. However, in addition to showing Web pages, it is also possible to start other applications and display documents using this display type.

## Trend display and archiving

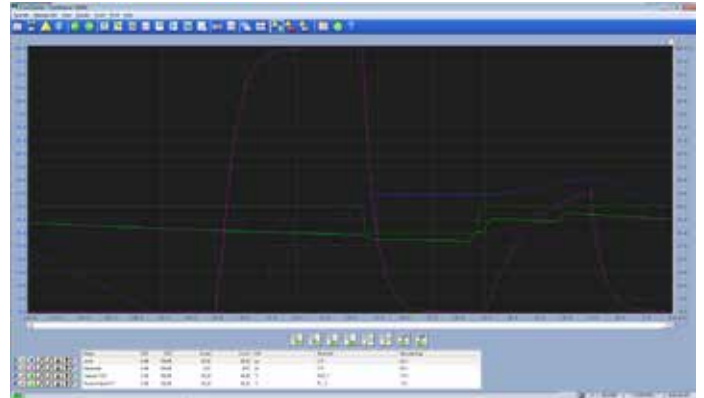

Trend Display

The chronological sequence of analog and binary process variables can be displayed as a trend display. The following can be shown in one trend display:

- Up to six signals in different colors
- The associated measuring point name with short text
- The current measured value with scale and unit used

The trend display can be altered by:

- Moving the time axis to show previous values
- Hiding trends
- Increasing and decreasing the signal range
- Selecting specific settings for each trend progression (e.g. color or interpolation)
- Highlighting individual trend curves
- Using a variable time range (seconds through to weeks)

If a trend display is configured with archiving, the measured values are recorded as a cyclical function of the operator station. The archived values can be backed up on any data medium or sent via file transfer protocol (FTP) to any subscriber on the Ethernet. They are then available for further evaluations and can be exported in CSV<sup>1)</sup> format using the separate Archive Browser (formerly DigiBrowse) software. The original data is binary coded and therefore protected against manipulation.

## User-defined trend displays

Operators can compile any process values in a trend display themselves by selecting the required process values from a list of all variable names. No additional engineering effort is necessary. The task of archiving this trend data on the hard disk of the operator station PC can also be carried out easily in the same way.

A prerequisite for user-defined trends is that the system contains a trend server.

<sup>1)</sup> CSV = comma separated value, a format in which data can easily be imported into Microsoft Excel and evaluated.

## 7.2 Messages & operator hints

Process disturbances are detected by the controllers and forwarded to the operator stations with a timestamp.

The Freelance system allows the following message types: system alarm (S1-S3), process alarm (P1-P4) fault message and operator hint message (P5). Process alarms are divided into fault messages (P1-P3) and switching messages (P4). When parameterizing the function blocks, it is possible to assign up to 4 messages to its limit monitoring units integrated into the block. Whereas the internal controller time is generally used for the timestamp for messages, you also have the option of using a special function block to assign external timestamps to alarms. In this way, for example, you can generate an alarm from a device connected to the Modbus in the correct chronological order with the device's timestamp. Different methods of acknowledgement can be selected for each priority level. Incoming messages are displayed in different colors, along with the name and disturbed status of the tag in accordance with their priority.

### 7 Message line

The upper area of the display is always reserved as a message line for the higher-level display of all message types from the entire process.

The message line optionally displays either the newest or oldest messages, as well as buttons for acknowledging messages and viewing operator hints. There is also a field for indicating overflow, a field for acknowledging alarms and a field showing the number of unacknowledged messages in the message list. For quick operation, the faceplate of the disturbed tag can be accessed directly from the message line.

Operators can choose between three different message line views:

- Standard view



- Area view



- List view



### Message list

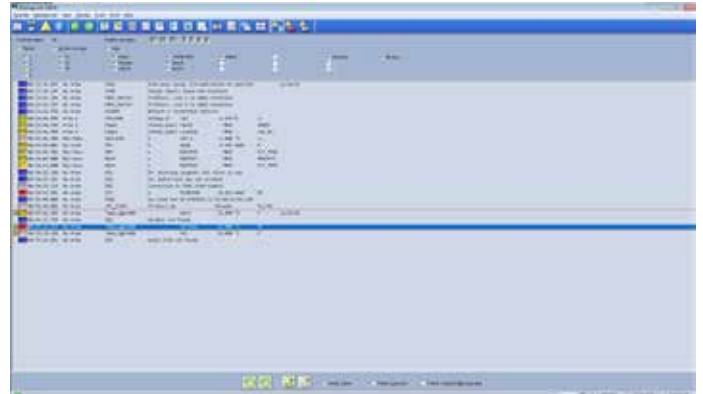

Figure 19: Message list

The message list offers an overview of all pending messages. It features a chronological list of fault, switch and system alarm messages. The latest message is placed at the beginning or end of the list, as configured. This message sequence can be altered by configuration.

Just as in the message line, different priorities are color-coded. Messages can be acknowledged both by block and by page. To provide a better overview, the user can filter certain priorities or plant areas on the screen display.

Other displays belonging to the tag, such as faceplates, graphic or trend displays, can be selected via tag specific aspect navigation from the message list simply by a right-click.

## Operator hint list

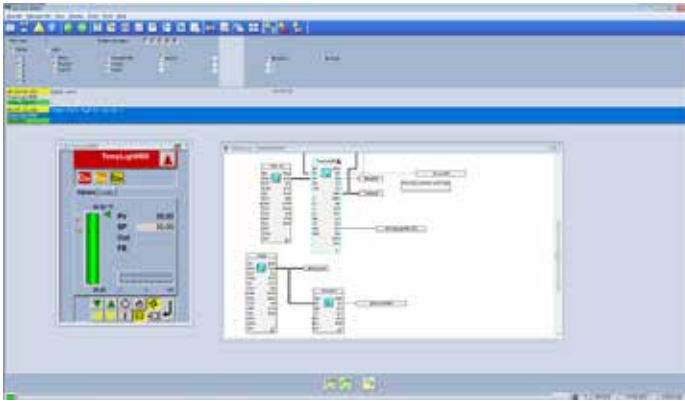

Figure 20: Operator hint list

A hint for the operator can be configured for each process alarm or event. Hints are intended to inform the operator about the cause of the message or about the procedure to be adopted for eliminating a process alarm. If necessary, hints can also provide further user help.

All configured hints are displayed in the hint list. Faceplates or other displays can also be called up directly from the hint list to operate a tag or analyze critical process situations.

## Logging

Logs are used to document events, states and sequences from the process. Log files can be displayed on the screen, printed, and saved on a CD, DVD, or memory stick for further evaluation.

In addition, the archived files can be automatically sent to any subscriber on the Ethernet via the file transfer protocol. The Archive Browser software makes it possible to view the data and

to convert it into ASCII (CSV file) for further evaluation, for instance using Excel.

The Freelance system features the following log types:

### Signal sequence log

The signal sequence log is used for logging events such as process and system messages, switching messages and hints. Even operator intervention can be logged in detail together with the user name and timestamp. The user can determine which message priorities are to be logged. Process messages and alarms are logged with time stamps of 1 ms resolution. "Signal sequence log 1" allows the operation of a line printer in order to immediately print every alarm when it is received.

## Operation log

At certain intervals or in certain situations, the plant log records the current values or states of process variables. It can run cyclically, or can be started and stopped manually or by an event. The output format is freely configurable as table or fill-in-the-blanks text.

## Disturbance course log

The disturbance course log is used to examine the course of disturbances. The process values before and after a disturbance are recorded with a high time resolution and archived in an operator station. Four logs of each type can be configured in one operator station.

## System diagnostics

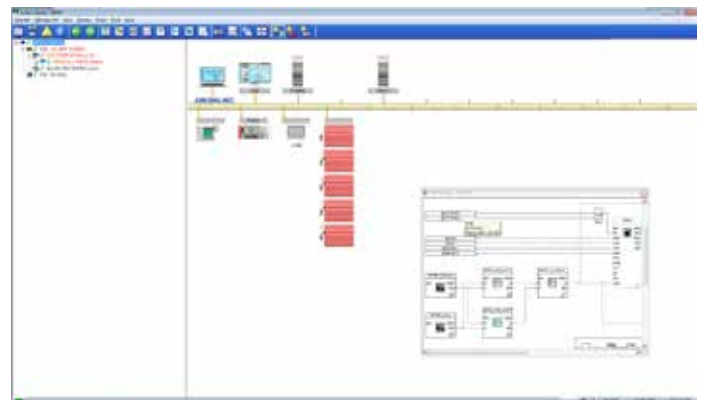

Figure 21: Easy system diagnostics with the system display

The current state of the hardware and software of a Freelance system is shown in the automatically generated system display. Here, information can be obtained in various degrees of detail about the status of an individual controller to a specific field device.

The simple system display is available to all operators of a Freelance operator station. Additional information is also available for field devices on Profibus or FOUNDATION Fieldbus.

## 7.3 Automation Sentinel

Name	Short Description	Article No.
Automation Sentinel Upgrade	Provides software licenses for upgrades/updates free of charge based on an existing and valid 'Automation Sentinel' agreement.  For Freelance systems < 6.2 indicate the Engineering (DigiTool/CBF) or Operations (DigiVis) hardkey number. For a system replacement enter the text "New Hardkey". Enter the "System ID" into the "Quotation ID" input field of the Wizard.	2PAA103267R01
Add to existing Sentinel Sub-description	Select this item if an existing system/project is to be extended by Freelance Operations/DigiVis. Indicate the System ID.	3BDS008515R09

## 7.4 Freelance Software languages

Name	Short Description	Article No.
Changing the current language	Changing the current language  Indicating the language is mandatory for both, first-time selection and language change. In the specification only one language is possible.  Please refer to ABB library (Products and Services / Control Systems / Freelance / System / System Versions) for the current status and availability of localized software and associated service packs.	3BDS008503R09
English language	English language	3BDS008502R0901
German language	German language	3BDS008502R0903
other languages	Freelance Operations is available in many other languages. Please refer to the price list.	see price list

## 7.5 Freelance Operations license

Name	Short Description	Article No.
Operations (Standard)	Freelance Operations (Standard) supports <ul style="list-style-type: none"> <li>- Control of all Tags</li> <li>- Graphical Displays, Trends, Faceplates</li> <li>- Historian, Reports, Operator Logs</li> <li>- SFC Display, Time Scheduler</li> </ul> Included in this license <ul style="list-style-type: none"> <li>- Extended Diagnostic</li> <li>- WEB display (runtime license)</li> <li>- Archive Browser</li> </ul> No server required. Order one Operations hardkey for each operator workplace	3BDS008790R09
Operations (Lite)	Freelance Operations (Lite) supports <ul style="list-style-type: none"> <li>- All features of Freelance Operations (Standard)</li> <li>- Limited number user defined graphic displays (max. 5 FGR)</li> <li>- No license options available</li> </ul> No server required. Order one Operations hardkey for each operator workplace.	2PAA114214R09



Name	Short Description	Article No.
Combined Workplace	Extends an Engineering workplace to a combined workplace. Freelance Operations (Standard) and Freelance Engineering can be used on the same workplace. Only in combination with an Engineering licenses. Order one Combi hardkey for each combined workplace.	3BDS008794R09

## 7.6 Connectivity

Name	Short Description	Article No.
Generic OPC	OPC Server (Windows 7, Windows 2008)	2PAA110434R09
OPC for Extended Automation	OPC Server (Windows 7, Windows 2008) Connection to 800xA Operations and Process Portal B	2PAA110435R09
Trend Server Package	For trending data on Freelance Operations without using trend acquisition function block. Only one Trend Server is possible per system.	3BDS008755R09

## 7.7 Freelance Operations options

Name	Short Description	Article No.
Dual Monitor Support	For a single operator workplace	3BDS008784R09
Control Aspect	Display (read only) of function block diagrams on a Freelance operator workplace.	3BDS009973R09

## 7.8 Freelance Operations hardkeys

Name	Short Description	Article No.
Combi Hardkey	Combi Hardkey for USB Port	3BDH000196R2
	Windows 2000, Windows XP and Windows 7 The Archive Browser doesn't need a hardkey.	
Operations Hardkey	Operations Hardkey for USB Port	3BDH000197R2
	Windows 2000, Windows XP and Windows 7	



# Chapter 8 – Freelance Engineering

- 8.1 Overview . . . . .170**
- 8.2 Configuration of functions . . . . .172**
  - 8.2.1 IEC 61131-3 . . . . .172
  - 8.2.2 Other Functions . . . . .173
  - 8.2.3 Fieldbus and field device configuration . . . . .175
- 8.3 Commissioning . . . . .176**
  - 8.3.1 Commissioning the fieldbus lines . . . . .176
- 8.4 Freelance Software languages . . . . .177**
- 8.5 Freelance Engineering license . . . . .177**
- 8.6 Freelance Engineering hardkeys . . . . .177**
- 8.7 Control - Software license . . . . .178**
  - 8.7.1 Base License . . . . .178
  - 8.7.2 Additional basic I/Os . . . . .178
  - 8.7.3 Controller license options . . . . .179
  - 8.7.4 Batch . . . . .179

## 8.1 Overview

With Freelance, all engineering work is performed with one single tool, Freelance Engineering, which works hand in hand with the visualization and operation tool Freelance Operations. Configuration of all plant objects – ranging from process graphics to field devices and operation of the entire plant – is easy and intuitive to perform.

The entire Freelance system can be configured either online, while the engineering tool is connected to a controller, or offline. For offline configuration, no controller is necessary. The application program, that was created during offline configuration, can later on be downloaded to a controller.

In particular, this is also true for FOUNDATION Fieldbus configuration, whereby Freelance Engineering can be used to generate the control-in-the-field application even without any devices being available.

Freelance Engineering offers the following features for configuration, parameterization and commissioning:

- A single software tool for configuration of the automation functions, the operator interface with displays and logs, and fieldbus parameters.
- Graphical configuration with powerful editors according to IEC 61131-3: Function block diagram (FBD); Instruction List (IL); Ladder diagram (LD); Sequential function chart (SFC) and Structured text (ST).
- A function block library with more than 220 tried and tested functions, greatly exceeding the basic ones outlined in IEC 61131-3.

- An extensive macro library containing more than 200 graphic symbols, which can be extended by the user.
- A project tree for flexible program generation and transparent program structuring.
- Verification of automation functions, with the chance to find and remove errors quickly and easily.
- Cross-reference function allowing variables and tags to be found easily in any editor right up to the graphic display.
- Importing and exporting of programs, displays, variables, tags and parts of the project tree.
- Password protection to prevent unauthorized project modification.
- Password protection for user-defined function blocks.
- Uniform and auto-generated system-wide graphical documentation of the entire user program, system communication and all field device parameters.
- Project file (application) backup on any data medium (hard disk, CD, memory stick, etc.). The project file includes the complete project with all programs, graphics, controllers, and field device parameters.
- Testing and simulation of user programs (e.g. interlocks) even without connected hardware using the controller emulator.

Bulk data manager allows to import signal lists from planning tools via Excel and fast duplicating of typical solutions.

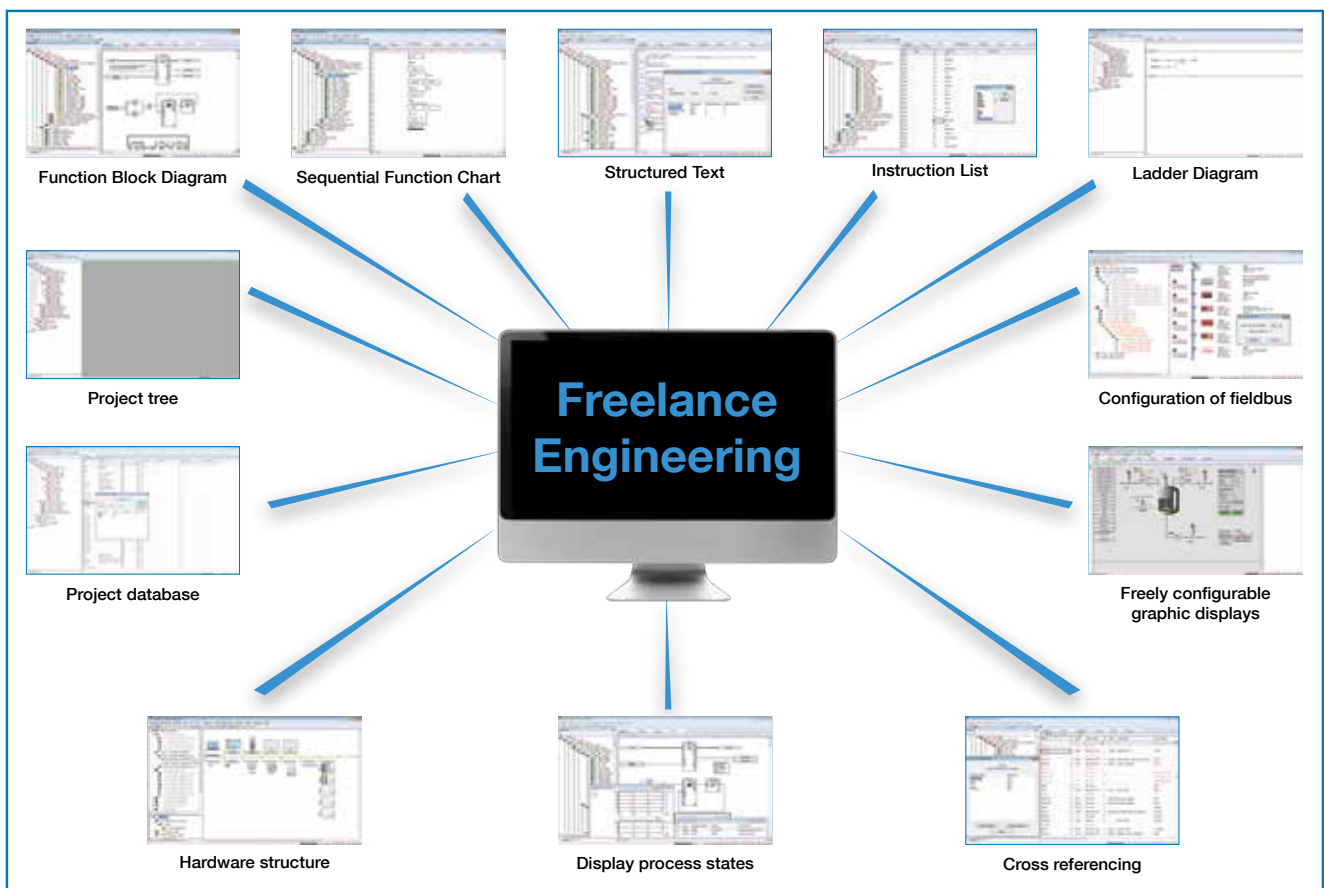

## Project tree

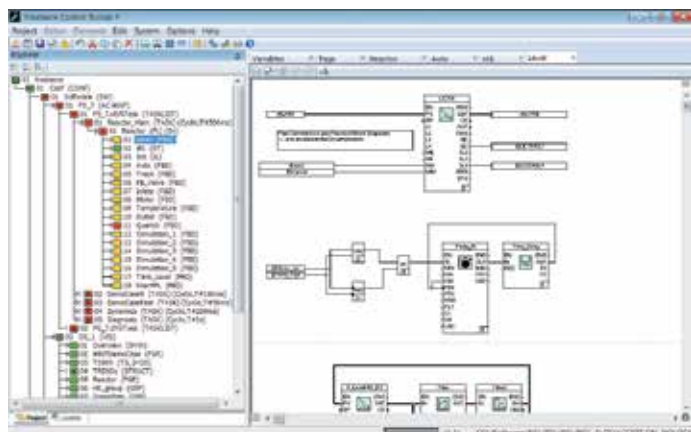

Figure 22: Project Tree with Function Block Diagram

The project tree is the central instrument for managing the entire user program and commissioning. All project configuration data is displayed as a tree structure.

Within the project tree:

- The configuration data in a project is structured
- Task levels and cycle times are defined
- Programs are assigned to the task levels
- Programs, displays and logs can be opened for editing, copied and moved
- Programs are checked for plausibility and their processing status displayed
- Project configuration data is exported and imported
- User programs are loaded into the process and operator stations

## Project data base

name	type	long text	type name
111111	...	...	...
111112	...	...	...
111113	...	...	...
111114	...	...	...
111115	...	...	...
111116	...	...	...
111117	...	...	...
111118	...	...	...
111119	...	...	...
111120	...	...	...
111121	...	...	...
111122	...	...	...
111123	...	...	...
111124	...	...	...
111125	...	...	...
111126	...	...	...
111127	...	...	...
111128	...	...	...
111129	...	...	...
111130	...	...	...
111131	...	...	...
111132	...	...	...
111133	...	...	...
111134	...	...	...
111135	...	...	...
111136	...	...	...
111137	...	...	...
111138	...	...	...
111139	...	...	...
111140	...	...	...
111141	...	...	...
111142	...	...	...
111143	...	...	...
111144	...	...	...
111145	...	...	...
111146	...	...	...
111147	...	...	...
111148	...	...	...
111149	...	...	...
111150	...	...	...

Figure 23: Tag list with cross references

All configured signals, variables and tags are managed in the Freelance system as lists in a common project database:

- List of variables (inputs, outputs, internal variables)
- Tag list (function blocks)
- Graphics
- Programs

Because the database is system-wide, data only needs to be entered once, avoiding further potential errors during configuration. The single project database file makes archiving or backup ease of use.

The list of variables and tags is created automatically when a user program is generated.

Other list functions include:

- Project-wide modification of name, comments, data or module type
- Search and display based on specified search criteria
- Cross-reference function permitting rapid, system-wide location of all programs and displays in which a selected variable or tag is used. This makes debugging very easy to do.

## 8.2 Configuration of functions

### 8.2.1 IEC 61131-3

#### Function block diagrams

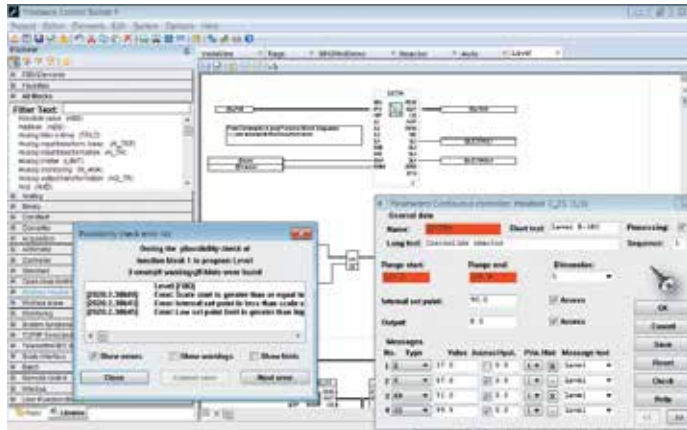

Figure 24: Program with parameterization screen and plausibility check

The function block diagram (FBD) is a graphical programming language. It keeps one or several function blocks. The inputs and outputs of the function blocks can be connected to create the signal flow. Freelance Engineering checks if the terminals of two function blocks can be connected. Inputs are always displayed on the left and outputs always on the right of a function block. With variables, values can be referenced from one diagram to another one. Two different access types to variables are available: read and write access. While write variables are written by a single function block, read variables can be used by several blocks.

The layout of the terminals and the color of signal flow lines provide information about the data type.

All parameters of the function blocks are defined in the function block diagram. Clearly structured and easy to understand parameter dialogs, in which all block-specific entries can be made, are available. Once completed, the function block diagram can be verified using a plausibility check for errors or syntactic accuracy. Any errors or warnings are displayed in a list, and it is possible to navigate directly to the source of the error by simply clicking on the relevant line in that list. The cross references in a program can be displayed for the whole system. The corresponding displays or programs can be called up directly in order to gain easy access to the variables or tags referred to.

A function block diagram (FBD program) , is configured as follows:

- Define name for FBD program
- Open editor for FBD program
- Select function blocks - position in the graphic area
- Connect functions with the signal flow lines
  - Enter input and output variables
- Define parameters for the functions
- Check FBD program for plausibility
- Correct any syntax errors

#### Sequential function charts

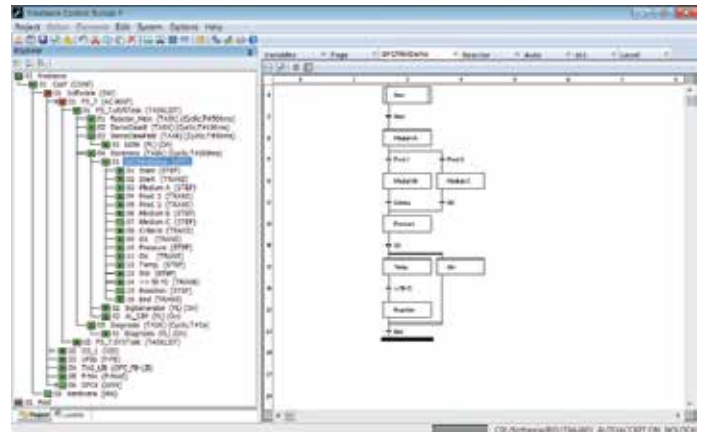

Figure 25: SFC program

The Sequential Function Chart (SFC) readily allows transparent, graphical creation of sequential control programs. To create an SFC program, steps are configured with assigned actions (commands) and transitions with step-enabling conditions. Programs (function block diagram, ladder diagram, structured text, or instruction list) can be assigned to the steps and transitions. A further feature of the sequential function chart is the facility for creating alternative and parallel branches as well as the synchronization of these sequential structures. At the same time as the sequential function chart is configured, the SFC display for operation and observation on the operator station is generated automatically.

#### Structured text

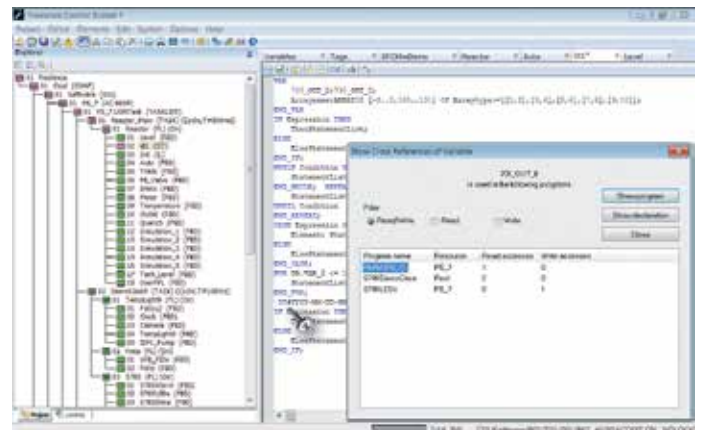

Figure 26: Structured text

Structured text (ST) is one of the text-oriented programming languages of IEC 61131-3, in which program processing is determined by instructions. All functions and function blocks can also be used in ST programs. The scope of the functions is partly covered by the ST operands. Function blocks can be used in the ST program following declaration.

Parameter definition of the function blocks also takes place in the same way as in the ladder diagram or function block diagram. In contrast to that of the function block diagram (FBD), the scope of functions of the structured text also includes conditional commands and loop commands, which are called using appropriate key words. The processing sequence is determined from the order of the commands in the ST editor. The only way to specifically change the order is to insert loop commands.

## Instruction lists

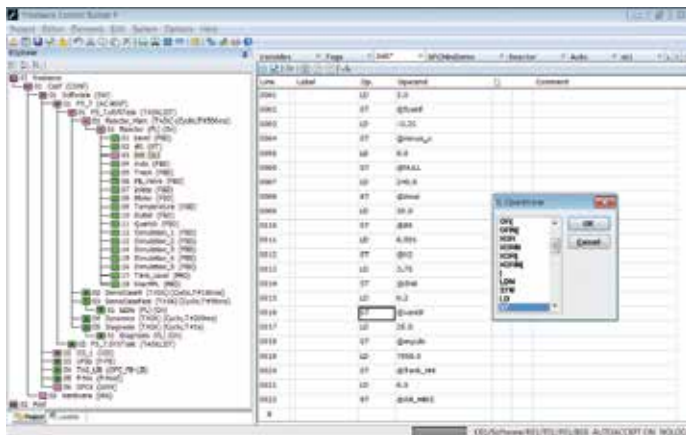

Figure 27: IL program

All Freelance processing functions can be defined by the instruction list (IL). The scope of the instruction list exceeds that of the function block diagram and sequential flow chart, as jump commands and program loops can also be programmed.

The operands can be displayed and entered with a selection list according to IEC 61131-3. Parameter definition of the function blocks also uses the same parameter definition screens as those used in the function block diagram.

## Ladder diagrams

Along with the function block diagram (FBD) and sequential function chart (SFC), the ladder diagram (LD) is also one of the graphical languages of the IEC 61131-3.

The ladder diagram language originates from the area of electromagnetic relay systems and describes the flow of current through individual rungs. The boundaries of a rung are defined on the right and left side by devices known as power rails, which have the logical state 1 (current is flowing). A rung is created with the elements of the ladder diagram (links, contacts and coils).

Functions and function blocks in the ladder diagram can be called up and used in the same way as in the function block diagram. Parameters are also defined for function blocks using the same parameter screens.

## 8.2.2 Other Functions

### Operation and observation functions

The following functions can be configured for operation and display:

- Custom graphic displays
- Web displays
- Standard display types: overview display, group display, trend display, time scheduler display
- SFC display
- Signal sequence, disturbance course and plant log
- Message list and message line
- Operator hint list.

Since the common system database is automatically accessed while configuring these functions, there is no need to re-enter the data.

### Standardized displays (pre-engineered)

Standard displays can be configured very easily using Freelance Engineering. To configure a group display, for example, it is only necessary to select the tags via the selection list. The entry is made automatically.

In this manner, up to 10 large analog faceplate tags can be entered per group display. The configuration procedure for the overview display is equally simple, as the containing displays are entered from a selection list.

- Display sections already created can be duplicated, moved, rotated in 90° steps, transposed or superimposed
- The combination of several graphic elements can be saved as a macro and stored in libraries to be used when desired
- The zoom function facilitates precise construction of the individual graphic display elements
- Import of bitmap files facilitates the generation of static background displays

The process variables are displayed in the dynamic section of the display – the foreground display. Specific process variables can be visualized simply by making the display elements dynamic.

The following types of dynamic elements can be used: Bar graphs and dynamic filling set to operate in different directions

- Superimposed numerical values and text variables
- Trend window
- Color change or symbol change to depict states
- Continuous or discrete position modifications of the graphic symbol
- Keys (buttons) for the direct execution of actions (e.g. write value or similar)
- Animated objects, e.g. mixers that turn realistically
- Tool tips

Selection fields can be defined at any position so that the operator can access any other displays using the mouse or keyboard.

## 8 Freely configurable graphic displays

## Hardware structure

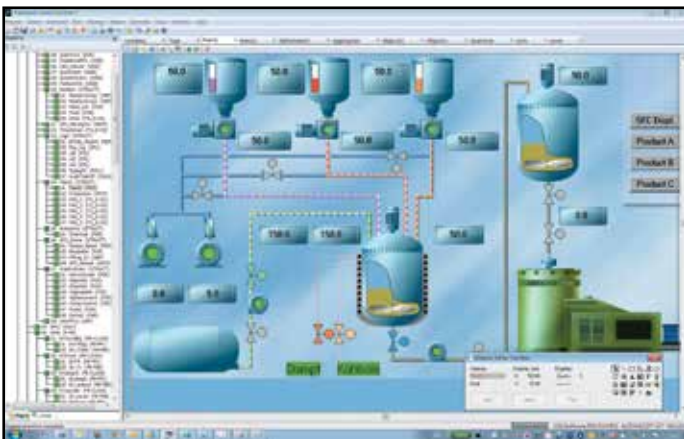

Figure 28: Graphics Editor

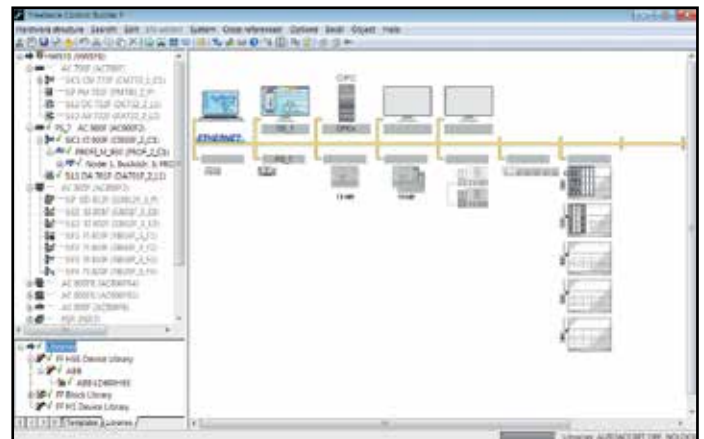

Figure 29: Definition of the hardware structure

Plant-specific graphic displays can be constructed for displaying the process. The graphic displays contain static and dynamic display elements.

The static part of the plant display – the background display – is composed of separate graphic elements which can be modified in color, line type and filling pattern and can, for example, display the schematic plant layout.

The following constructional aids in the system make it easier to create displays:

- Static elements such as lines, polylines, rectangles, polygons, ellipses, arcs and texts are created, for example, by specifying the start and end points

The required hardware structure can be configured in a graphical system overview and the system communication can also be defined there. It is possible to assign particular Freelance operator stations to specific controllers. Furthermore, detailed information can be obtained on the operator and process stations, together with their modules and the controllers with their connected fieldbus lines. In the station overview display, the operator and process stations can be equipped using selection lists. Specifications for processing, display and I/O channel assignment can be made for the individual modules of the controllers.

And all this with just a few clicks.



## 8.2.3 Fieldbus and field device configuration

The respective bus parameters, for instance the baud rate, number of subscribers and time constants, can be set for each fieldbus module. Freelance Engineering also suggests a setting for the bus parameters in line with how the fieldbus is equipped. This makes work easier for those new to the subject.

### PROFIBUS

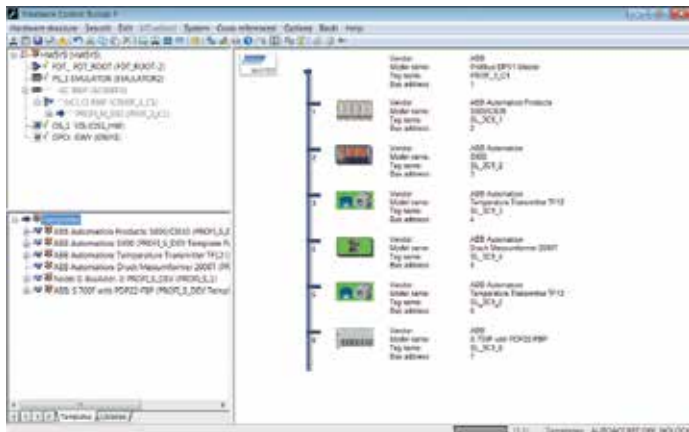

Figure 30: Configuration of the fieldbus line (PROFIBUS)

In the configuration view of the fieldbus line, new PROFIBUS slaves can be integrated into the fieldbus line using a GSD-file or FDT technology.

Using the template concept, it is also possible to integrate completely pre-configurable PROFIBUS slaves by means of drag and drop. The intelligent DP / PA Linking Device is transparent with regard to configuration, allowing PA devices to be viewed as if they were connected to the PROFIBUS DP. Parameter definition screens are then available in the device display for defining parameters for both remote I/O and PA field devices.

### HART

HART devices connected to the S800 or S900 Remote I/O can be configured with the aid of HART DTMs. For S900, also HART templates can be used. They consist of preconfigured DPV1 services which tunnel a HART command via the PROFIBUS to the HART device on the analog channel of a particular S900 I/O module. Users can also create HART templates themselves.

## FOUNDATION Fieldbus

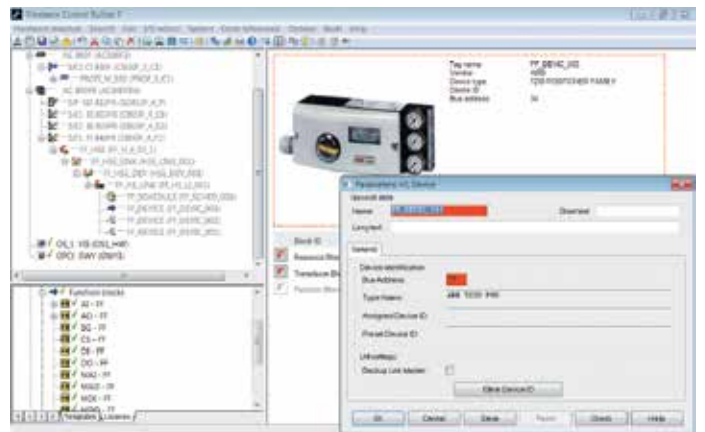

Figure 31: Configuration of the fieldbus line (FF)

The devices are configured in the feedforward part by linking the Device Description (DD) files. This makes it possible to configure the FF without the field devices being physically connected to the controllers.

The devices are configured on the H1 links of the LD 800HSE Linking Devices. As Freelance Engineering supports control in the field for FF devices, it is possible to configure function charts that interconnect the function blocks in the individual FF devices. Freelance Engineering then automatically generates a process that is passed on to the Link Active Scheduler (LAS). Redundant Link Active Schedulers are also supported. However, it is also possible to use the FF devices “only” as I/O suppliers and use the function blocks in the controllers.

### Graphical documentation

The fully graphical forward documentation allows configured programs and displays to be printed. The documentation is always up-to-date, as the current configuration data is accessed. Various sorting criteria, such as drawing numbers, assure an orderly and transparent output of the data to be documented.

The scope of documentation can be specified as desired by the user, such as:

- Program and display contents, cross references, parameter definition data and comments
- System overview and hardware configuration

The documentation specification can be stored for future use. The FBD, IL, LD, SFC and ST programs, displays, etc. are documented in the form in which they appear on the screen. Using Freelance documentation management, complete or partial project documentation can be produced without effort. It is also possible to include bitmaps (such as customer logos) in the drawing footer.

## 8.3 Commissioning

During commissioning, the user programs are loaded into the operator and process stations. It is also possible to:

- Load modifications
- Start and stop process stations
- Start, stop or reset tasks
- Define and activate parameters for function blocks
- Define and activate parameters for field devices
- Display, set and track process values
- Combine any process values at any time in a trend window
- Perform version and status checks
- Perform system diagnoses right up to the field device

### Displaying process states

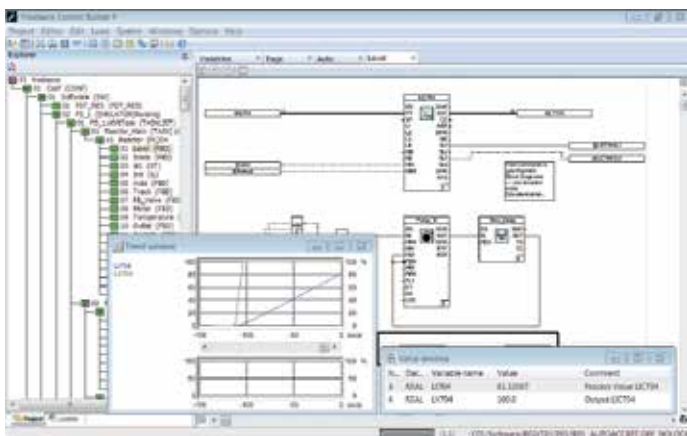

Figure 32: Trend and value window during commissioning

The editors for displaying the configured programs can also be accessed during commissioning. As opposed to during configuration, the process states of the I/O variables are also displayed in the program.

The status of the binary process signals is displayed in the FBD display by a change in the graphical representation of the signal flow lines.

Value and trend windows are available for displaying process values. They offer an optimal overview of the current process values for commissioning and test purposes.

Here, the user is not restricted to the display of I/O variables for the program currently shown on the screen. Variables from other programs and / or controllers can also be displayed, as well as values from connections between various function blocks of the current program.

### Modifying parameters

Parameters can also be modified during the commissioning phase, allowing optimal program settings for the process. These parameters can be altered from either the engineering station or the operator station.

Whether the changes made are retained permanently or only temporarily is decided by the commissioner.

Through a parameter upload, it is possible to view all parameter modifications made in a particular period of time and to select those which are to be saved in order to be used at the next cold start.

Other features allow you to force inputs and outputs and to specify new values for simulation purposes.

### 8.3.1 Commissioning the fieldbus lines

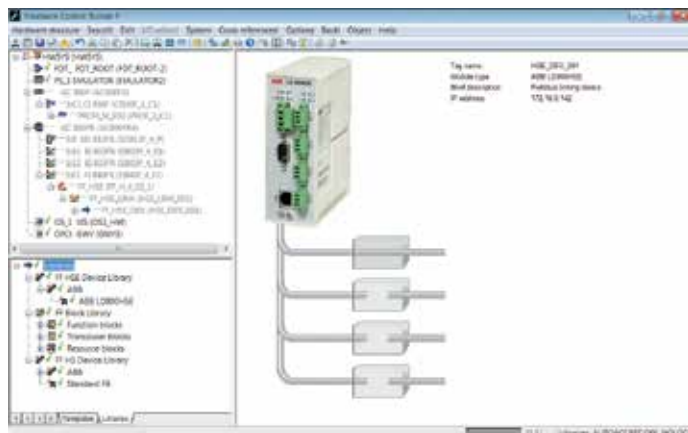

Figure 33: Online diagnosis of fieldbus components

### PROFIBUS

The fieldbus line overview shows whether the configured PROFIBUS I/O and PA devices are available. In addition, the bus can be scanned using Freelance Engineering in order to detect new or incorrectly configured devices. Such devices can then be given the correct address from Freelance Engineering via the PROFIBUS.

During commissioning, Freelance allows you to compare configured parameters with the parameters that exist in the device. This makes it possible to detect device parameters that have been changed locally and transfer them to the configuration by means of uploading. When the PROFIBUS device transmits diagnoses, they can be displayed by Freelance Engineering. When FDT / DTM technology is used, specific diagnostic options can be used, provided that the device manufacturer has incorporated such options in the DTM.

Individual PROFIBUS devices can be removed from cyclical data traffic in order to perform maintenance without it being necessary to stop the fieldbus.

### FOUNDATION Fieldbus

Live lists displaying which devices exist are available for HSE and H1.

During commissioning, Freelance allows you to compare configured parameters for the device modules with the parameters that exist in the device. This makes it possible to detect device parameters that have been changed locally and transfer them to the configuration by means of uploading.

The Link Active Scheduler (LAS) can be stopped in order to interrupt processing of the control loops in a H1 link.

## 8.4 Freelance Software languages

Name	Short Description	Article No.
Changing the current language	Changing the current language  Indicate the Engineering hardkey number and the new language. Setup CD and the user documentation in the chosen language are to order additionally.	3BDS008503R09
Available languages	The Freelance Software is available in various languages. For article numbers see the price list.	see price list

## 8.5 Freelance Engineering license

Engineering license for one workplace supporting the following controllers:

- AC 900F, AC 800F, AC 700F
- DCP 02/10, DFC 01/02

For engineering at least one setup CD, one license (Standard or Professional), one hardkey and a language selection are required.

Name	Short Description	Article No.
Engineering (Standard)	Software License Order one Engineering hardkey for each engineering workplace  Freelance Engineering (Standard) supports – 16 Character Tag Names – User Defined Function Blocks (runtime license) – OPC Function Block Classes (runtime license) Included in this license – WEB Display Configuration	3BDS008510R09
Engineering (Professional)	Software License Order one Engineering hardkey for each engineering workplace  Freelance Engineering (Professional) supports – All features of Freelance Engineering (Standard) – Security Lock – User Defined Function Blocks (developer license) – OPC Function Block Classes (developer license) – FDT Technology – DTM Device Driver Please check the list of DTMs which are approved by ABB for use with Freelance Engineering in version 2016.	3BDS008520R09

## 8.6 Freelance Engineering hardkeys

Name	Short Description	Article No.
Engineering Hardkey for USB	Windows 2000, Windows XP and Windows 7	3BDH000198R2

## 8.7 Control - Software license

Here you find software licenses for the following controllers:

- AC 900F
- AC 800F
- AC 700F
- DCP 02/10, DFC 01/02

This license releases the specified number of controllers (process stations) in the Freelance project tree.

For every used controller (process station) one license is needed:

One redundancy couple = 1 controller = 1 control software license;  
Gateway (e.g. OPC) = no controller = no control software license.

Control Software license supports:

- IEC 61131-3, binary and analog
- PROFIBUS
- Closed loop control
- Freelance Operations
- 800xA Operation (requires item "OPC for Extended Automation")

Included in a controller license

- 50 I/Os
- Tune (Self tune PID)
- Sequence of Events (only Rack I/O)
- Phase Logic Interface PLI
- Programming Interface API
- Modbus Serial (RTU)
- Modbus TCP (AC 700F/900F)
- Foundation Fieldbus (AC 800F)

Not supported with AC 700F/AC 900F

- Foundation Fieldbus
- Coupling Sartorius
- Protronic Remote Control.

### 8.7.1 Base License

Name	Short Description	Article No.
Control Software license	Number of supported controllers incl. 50 I/Os each	2PAA110432R09

### 8.7.2 Additional basic I/Os

The maximum number of I/O license depends on CPU type and application. Please use DigiSize for load calculation. The number of I/Os relevant for licensing is determined by counting only those I/Os that are in use in the field.

Name	Short Description	Article No.
Set of 50 I/Os	Set of additional 50 I/Os	2PAA110433R09

## 8.7.3 Controller license options

Additional option to Control Software Basic. This option must be ordered for every controller, where you want to use it.

Name	Short Description	Article No.
TeleControl	Support for IEC 60870-5-101 and -104	3BDS008758R09
	Check whether the implemented subset of functionality meets your requirements. IEC 60870-5-104 is currently not released with DCP 02/10 and DFC 01/02.	

## 8.7.4 Batch

Interfaces to Batch applications. The Batch application has to be ordered separately.

Name	Short Description	Article No.
Freelance Formulation 1.1	Essential Recipe Manager	2PAA110436R09
	This license includes a license for the Freelance Formulation batch application.	
Freelance Batch	Interface to Freelance Batch	2PAA110437R09
Batch for Extended Automation	Interface to 800xA Batch	2PAA110438R09
	Please refer to Extended Automation 800xA price list for the batch application (license).	



## Chapter 9 – Media and documentation

9.1 Product box . . . . .	182
9.2 Software CD . . . . .	182
9.3 Formulation Software 1.1 . . . . .	182
9.4 Documentation CD . . . . .	182

## 9.1 Product box

Including Software CD, Documentation CD and a “Getting Started” manual. For other languages than German and English, please order individual articles, namely a Software CD and a Documentation CD. The “Getting Started” document can also be downloaded from ABB library.

Name	Short Description	Article No.
Product Box	Freelance, Product Box	3BDS008536R0903
	Freelance 2016 Product Box, German and English	

## 9.2 Software CD

Please refer to ABB library (Products and Services / Control Systems / Freelance / System / System Versions) for the current status and availability of localized software and associated service packs.

Includes Freelance Software of version 2016 (Engineering, Operations, On-line Help, Profibus FDT Library, Foundation Fieldbus, Security Lock, Archive Browser, OPC Server, Trend Server and CBF Viewer).

Name	Short Description	Article No.
Freelance Software 2016	available in various languages	3BDS008531Rxxxx (see price list)

## 9.3 Formulation Software 1.1

Includes Freelance Formulation Software of version 1.1 and user documentation.

Name	Short Description	Article No.
Freelance Formulation	Freelance Formulation Software 1.1, German and English CD ROM	2PAA112628R0203
	Including user documentation Use of Formulation 1.1 is restricted to Freelance 2016.	

## 9.4 Documentation CD

Includes user documentation for Freelance.

Name	Short Description	Article No.
Freelance Documentation 2016	German and English CD	3BDD012530R0903



# Chapter 10 – Add-ons, extensions, and service

10.1 Automation Sentinel . . . . .	184
10.2 Asset Management . . . . .	185
10.3 System Integration . . . . .	185
10.4 Training . . . . .	185
10.5 Repair Services . . . . .	185



**A full range of lifecycle services from spare parts, repair, training and technical support to upgrades and evolution to help you keep production running, maximize system lifecycle, optimize processes and deliver operational excellence.**

#### **Comprehensive customer service**

Service means a profitable investment in continually maximizing and optimizing the availability, performance, quality and security of a plant. ABB's support covers the following areas:

- Customer Support Services
- Training
- Spare Parts & Logistics, Repair
- Process, Application & Consulting Services
- Service agreements
- Extensions, upgrades and retrofits

aging their ABB control system software life cycle costs. It provides:

- Optimal operation and availability of installed ABB assets through 24/7 support and maintenance services
- Better productivity through enhanced software functionality
- Lower support cost and more predictable software management budgeting as a result of annual subscription fee
- Access to the most current system documentation
- Evolution to more advanced human system interface, control platform, information management and connectivity
- A way to stay current with the latest technology standards

The Automation Sentinel Program provides solutions for the main challenges system owner face to achieve maximum availability and reliability of the control system:

- Software maintenance and upgrades
- Cyber and IT security
- Online access to relevant information
- Control system software and performance checks

It also provides an evolution path to newer technology system enhancements to improve plant effectiveness and long-term support through annual maintenance subscription budgeting.

#### **Benefits**

- **Maintain operation and avoid loss of production:** Higher productivity through enhanced software functionality
- **Continuous optimization of your process operations:** Improves system availability, performance and reliability with predictable costs
- **Reduces overall maintenance costs:** Yearly subscription provides predictability for plant budgeting
- **Complete flexibility:** Improve your control system over time. Always the best, lowest risk path forward
- **Protection of intellectual property:** Your operator graphics and control programs are protected when new technology is implemented

For more information please refer to the Automation Sentinel brochure 3BDD015294.

## 10.1 Automation Sentinel

Control system life cycle management and investment protection have always been cornerstones of ABB's development programs. Over the last 30 years, ABB has built a large installed base across diverse industries. ABB looks after its installed base by crafting solutions that ensure the continued productivity, reliability and capability of all installed ABB assets.

With this 30 year track record, ABB has established a history of 'Evolution through enhancement' developing new products in a way that allows for incremental adoption, minimum risk to operations and maximum investment protection. In support of this mission is Automation Sentinel, ABB's control system life cycle management and support program. With this program, customers can keep control software up-to-date and maintain a flexible path forward to new system software technology. Automation Sentinel provides the fundamental software support deliverables required to maintain operation and maximize the availability of the installed ABB control system. Automation Sentinel assists system owners in actively man-



## 10.2 Asset Management

If you want to keep your production plant up and running in the long term, you need information about the availability and degree of wear and tear of your equipment. All of the information necessary for this is available; integrated and included in the basic software package of the Freelance control system. As a result, several customers have been able to avoid making investments that appeared essential but were in fact unnecessary. Freelance allows the use of modern asset management methods for more efficient maintenance and optimization – helping for instance to make optimum use of plant capacity.

## 10.3 System Integration

Our instrumentation and control specialists, or our certified partners in system integration, will be happy to assist you in planning and implementing your automation project. ABB Automation's staff can also work with you to plan and implement the installation of a Freelance system in your plant. Under this arrangement, the ABB Automation Engineering Department will compile the specific project documentation for you. This can include functional diagrams, circuit diagrams, configuration documentation, and operating documentation including system descriptions and instructions for operation, modes of operation and plant maintenance.

At many sites, ABB Automation has its own commissioning engineers who work together with planning engineers, process instructors and operators to commission your plant, optimize it, perform a test run and hand over the system to the operator.

## 10.4 Training

To make sure your operators are fully knowledgeable in the operation of the Freelance distributed control system, we offer a range of technical training courses.

In addition, we offer a computer-based training program for Freelance on a multimedia DVD. This will provide you with the basic knowledge you need for configuration, therefore allowing you to start using the system very quickly and efficiently.

## 10.5 Repair Services

ABB repair and troubleshooting support services are available throughout the life cycles of the plant and its process control systems.

### We repair and return your unique unit

Our repair network provides repairs that meet original equipment specifications. Our world-class turnaround time for repairs is typically less than two weeks. We include a repair report in every return shipment.

Please contact us for more information about our Repair Services or visit our web page: [www.abb.com/freelance](http://www.abb.com/freelance). You find the information under "Services".

# Index

## A

Accessories for AC 900F CAN Bus installation	26
TB 870F Terminal Block	26
TK 811F, CAN Cable	26
TK 831F, CAN Cable	26
TP 910F CAN Bus Termination Plug	26

Accessories for S900	150
----------------------	-----

Al-profile	129
------------	-----

AM 810F	51
---------	----

AM 895F	52
---------	----

### Analog Input Modules

AI 723F	97
AI 731F	100
AI801	137
AI810	130
AI815	130
AI820	130
AI825	130
AI830A	130
AI835A	130
AI843	130
AI845	130
AI890	130
AI893	131
AI895	131
AI910	144
AI930	145
AI931	145
AI950	146

### Analog Input/Output Modules

AC 722F	94
AX 721F	107
AX 722F	111
DA 701F	115

### Analog Output Modules

AO 723F	104
AO801	137
AO810V2	131
AO815	131
AO820	131
AO845A	131
AO890	131
AO895	131
AO910	146
AO920	147
AO930	147

## B

### Batch

Extended Automation Batch	179
Freelance Batch	179
Freelance Formulation	179

Battery	
TA 951F	25

### Battery Modules

AM 811F	51
SB 808F	51
SY 809F	51
TA521	60

### BI100

Field Housing roof	148
--------------------	-----

BI923S	150
--------	-----

BI924S	150
--------	-----

## C

### Cables

TK 701F	60
TK 802F	53
TK 807F	53
TK 808F	53
TK 809F	53
TK 811F	53
TK 821F	53
TK 831F	53
TK 890F	53
TK 891F	53

CAN Communication Interface for AC 900F	22
---	----

Changing the current language	177
-------------------------------	-----

CI 741F	69
---------	----

CI801	128
-------	-----

CI840A	128
--------	-----

Clamps	53
--------	----

Clips	53
-------	----

Commissioning	176
---------------	-----

### Communication Interface

CI801	128
CI840A	128

Control Aspect	167
----------------	-----

Controller license options	179
----------------------------	-----

### Controllers

AC 700F	54
AC 800F	28
AC 900F	12
Overview	10
PM 783F	56
PM 803F	36, 50

Control Software License	178
--------------------------	-----

### Control Software Option

TeleControl	179
-------------	-----

CP-A CM	64
---------	----

CP-A RU	64
---------	----

CP-C MM	64
---------	----

## D

DC 705F ..... 71

### Digital Input Modules

CD 722F ..... 72  
DI 724F ..... 87  
DI801 ..... 137  
DI802 ..... 137  
DI803 ..... 137  
DI810 ..... 132  
DI811 ..... 132  
DI814 ..... 132  
DI818 ..... 132  
DI820 ..... 132  
DI821 ..... 132  
DI828 ..... 132  
DI840 ..... 132  
DI890 ..... 132  
DP910 ..... 144

### Digital Input/Output Modules

DA 701F ..... 115  
DC 722F ..... 77  
DC 723F ..... 80  
DC 732F ..... 83  
DX 722F ..... 89  
DX 731F ..... 91  
DX910 ..... 143

### Digital Output Modules

DO801 ..... 137  
DO802 ..... 137  
DO810 ..... 133  
DO814 ..... 133  
DO815 ..... 133  
DO818 ..... 133  
DO820 ..... 133  
DO821 ..... 133  
DO828 ..... 133  
DO840 ..... 133  
DO890 ..... 133  
DO910 ..... 143

### Dimensional drawings

CPU Terminal Base ..... 59  
I/O terminal units ..... 122

### Display Unit

TD 951F ..... 25

DP820 ..... 134

DP840 ..... 134

Dual Monitor Support ..... 167

## E

Engineering ..... 177

Engineering (Professional) ..... 177

Engineering (Standard) ..... 177

## F

Faceplates ..... 162

FH660S

Field Housing ..... 148

FH680S

Field Housing ..... 148

FI 810 ..... 44

FI 820F ..... 45

FI 830F ..... 46

FI 840F ..... 47

Fieldbus and field device configuration ..... 175

Field Housing

CB220 ..... 149

IP920 ..... 150

Field Housing roof ..... 148

FOUNDATION Fieldbus network components .. 156

Freelance Engineering

Languages ..... 177

Freelance Engineering License ..... 177

Freelance Operations ..... 166

Languages ..... 166

License ..... 166

Freelance Rack I/O

How to connect ..... 23

FS801K01 ..... 129

Function block diagrams ..... 172

## G

Generic OPC ..... 167

Group display ..... 162

## H

Hardkey

Combi ..... 167

Freelance Engineering ..... 177

Freelance Operations ..... 167

Hardware structure

Engineering ..... 174

## I

IEC 61131-3 languages ..... 172

Instruction lists .....	173
Interface Modules	
BI914S .....	150
CI 930F .....	20, 21, 22, 58
EI 813F .....	42, 50
FI 810F .....	44, 51
FI 820F .....	45, 51
FI 830F .....	51
FI 840F .....	51
RLM01 .....	156
S700 .....	153

## L

Labels	
Front label set .....	129
IL910 .....	150
Label set, item design .....	129
Label Set S800L .....	137
TA525 .....	26
Label sets S800	
S800 Label sets .....	134
Ladder diagrams .....	173
LD 800HSE .....	156
License	
Freelance Engineering .....	177

## M

Markers for I/O Modules	
TA523 .....	127
TA525 .....	127
Markers for labelling CPU and I/O modules (AC 900F, AC 700F, S700) .....	26
Message line .....	164
Message list .....	164
Mounting kit .....	129
Mounting profile 1800 .....	129

## N

Network Components	
FOUNDATION Fieldbus .....	156
PROFIBUS .....	156

## O

OPC for Extended Automation .....	167
Operations (Lite)	
License .....	166
Operations (Standard)	
License .....	166
Operator hint list .....	165

Overview display .....	161
------------------------	-----

## P

PDA11-FBP .....	127
PDA12-FBP .....	127
PDF11-FBP .....	127
PDM11-FBP .....	127
PDP22-FBP .....	126
PDR11-FBP .....	127
PDV11-FBP .....	127
PDV12-FBP .....	127
PDX11-FBP .....	127
Plant-specific displays .....	161
PM 803F .....	36
Power Supplies	
CP-C 24 .....	62
SA 811F .....	50
SA911 .....	149
SA920 .....	142
SD 812F .....	40, 50
SD831 .....	139
SD832 .....	139
SD833 .....	140
SD834 .....	140
SS832 .....	140

Power supplies for S800 I/O .....	139
Profibus DP configuration for S700 .....	154
PROFIBUS network components .....	156
Project data base .....	171
Project tree .....	171

## R

Recipe Management .....	179
RW 856F .....	53
RY 885F .....	53

## S

S700 I/O .....	67
S700 I/O terminal units .....	121
S800 I/O user documentation	
User documentation, S800 I/O .....	140
S800 Remote I/O .....	128
S900 141	
S900 - BI100 .....	148
S900 Remote I/O .....	141
Sequential function charts .....	172
Service .....	183

SFC display .....	162
Software/Documentation	
Automation Sentinel Upgrade .....	166
Batch for Extended Automation .....	179
Changing the current language .....	166
Combined Workplace .....	167
Control Software license .....	178
English language .....	166
Freelance Batch .....	179
Freelance Documentation V2013 .....	182
Freelance Formulation .....	179
Freelance Software V2013 .....	182
German language .....	166
other languages .....	166
Product Box .....	182
S800 I/O .....	140
TeleControl .....	179
Structured text .....	172

## T

TA523 .....	127
TA525 .....	127
TA526 .....	60
TA 724F .....	60
TA 951F .....	25
TB805 .....	138
TB806 .....	138
TB807 .....	138
TB820V2 .....	138
TB840A .....	138
TB842 .....	138
TB845 .....	138
TB846 .....	138
TB 870F .....	26, 53
TD 951F .....	25
TeleControl	
Control Software Option .....	179
Terminal Units	
TB 711F .....	58
TU 705F .....	123
TU 706F .....	123
TU 715F .....	124
TU 716F .....	124
TU 731F .....	125
TU 732F .....	125
TU805K01 .....	134
TU810V1 .....	134
TU811V1 .....	134
TU812V1 .....	134
TU813 .....	134
TU814V1 .....	134
TU830V1 .....	135
TU831V1 .....	135

TU833 .....	135
TU834 .....	135
TU835V1 .....	135
TU836V1 .....	135
TU837V1 .....	135
TU846 .....	128
TU847 .....	129
TU921 .....	142
Terminal Units for S700 I/O .....	121
Time scheduler display .....	163
TK212A .....	129
TK801 .....	138
TK811 .....	139
TK 811F .....	26
TK812 .....	139
TK 831F .....	26
TP 910F .....	26
Trend display .....	163
Trend Server Package .....	167
TU 709F .....	123
TU 710F .....	123
TV 821F .....	53
TV 822F .....	53
TV 823F .....	53
TV 824F .....	53
TV 825F .....	53
TV 831F .....	53
TV 832F .....	53

# For your notes

A series of horizontal dotted lines for taking notes.







# For your notes

A series of horizontal dotted lines for taking notes.





# For your notes

A series of horizontal dotted lines for taking notes.



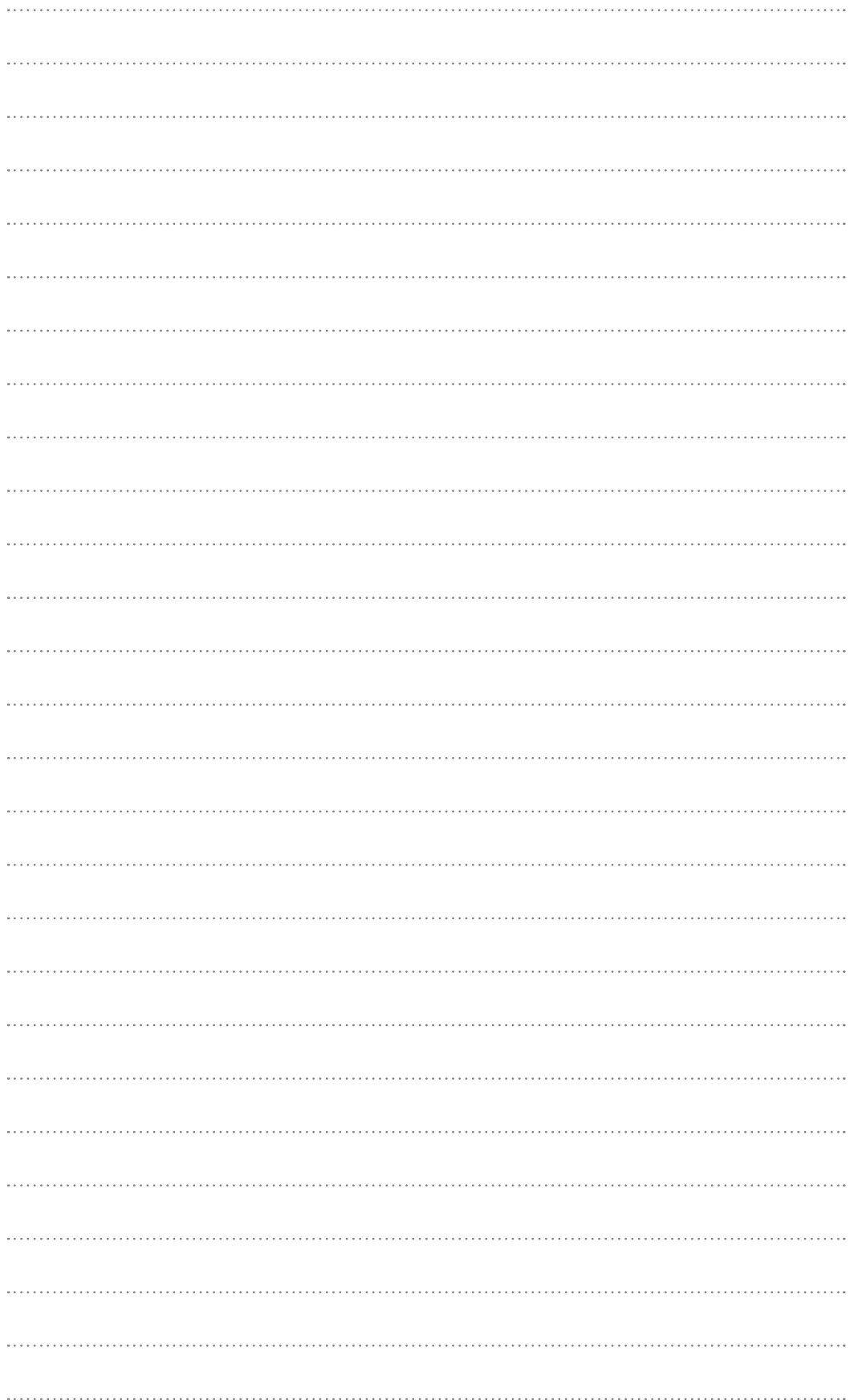

A

# Contact us

You can find the address of your local sales organization on the ABB homepage:

[www.abb.com/freelance](http://www.abb.com/freelance)

[www.abb.com/controlsystems](http://www.abb.com/controlsystems)

**Note:** We reserve the right to make technical changes or modify the contents of this document without prior notice. With regard to purchase orders, the agreed particulars shall prevail. ABB does not accept any responsibility whatsoever for potential errors or possible lack of information in this document.

We reserve all rights in this document and in the subject matter and illustrations contained therein. Any reproduction, disclosure to third parties or utilization of its contents – in whole or in parts – is forbidden without prior written consent of ABB.

Copyright © 2016 ABB  
All rights reserved